

Roof Drawing Index
Health Sciences District

Last Updated: 3/27/2012

Bldg No	Building Name	Plan view Drawing	Roof Penetrations Drawing	Date Assessed
032	JACKSON HALL	Y	Y	10/1/2010
052	PIONEER HALL [see Housing file*]	Y	Y	11/1/2010
063	COMSTOCK HALL [see Housing file*]	Y	Y	11/1/2010
064	COFFMAN MEMORIAL UNION	N	N	9/29/2011
068	CENTENNIAL HALL [see Housing file*]	Y	Y	11/1/2010
069	VARIETY CLUB RESEARCH CENTER	Y	Y	10/1/2010
070	BOYNTON HEALTH SERVICE	Y	Y	11/1/2010
074	MAYO BUILDING	Y	Y	10/1/2010
087	711 EAST RIVER PARKWAY	N	N	
088	717 EAST RIVER PARKWAY	N	N	
105	TERRITORIAL HALL [see Housing file*]	Y	Y	11/1/2010
107	MASONIC CANCER CENTER	Y	Y	10/1/2010
109	VFW CANCER RESEARCH CENTER	Y	Y	10/1/2010
110	FRONTIER HALL [see Housing file*]	Y	Y	11/1/2010
111	DIEHL HALL LABORATORIES	Y	Y	10/1/2010
115	CHILDRENS REHAB CENTER	Y	Y	10/1/2010
141	OAK STREET PARKING RAMP	N	N	
142	MOOS HEALTH SCIENCE TOWER, MALCOLM	Y	Y	10/1/2010
143	DWAN VARIETY CLUB CARDIO RESEARCH CENTER	Y	Y	10/1/2010
144	PHILLIPS - WANGENSTEEN BUILDING	Y	Y	10/1/2010
147	WEAVER - DENSFORD HALL	Y	Y	10/1/2010
172	WEISMAN ART MUSEUM, THE FREDERICK R.	Y	Y	7/1/2010
178	NILS HASSELMO HALL	Y	Y	10/1/2010
183	EAST RIVER PKWY GARAGE	N	N	
186	MOLECULAR AND CELLULAR BIOLOGY	Y	Y	10/1/2010
189	YUDOF HALL, MARK G. [see Housing file*]	Y	Y	11/1/2010
193	717 DELAWARE BUILDING	Y	Y	10/1/2010
27		22	22	

*Roof Drawings organized into (4) Packages; East Bank, St Paul / West, Health Sciences & Housing

Roof ID

Building: HS032 - Jackson Hall - (321 Church Street SE Minneapolis)

Total Area: 26,618 sf

A	21,397 sf	E	300 sf
B	1,324 sf	F	94 sf
C	503 sf	G	1,605 sf
D	1,279 sf	H	116 sf

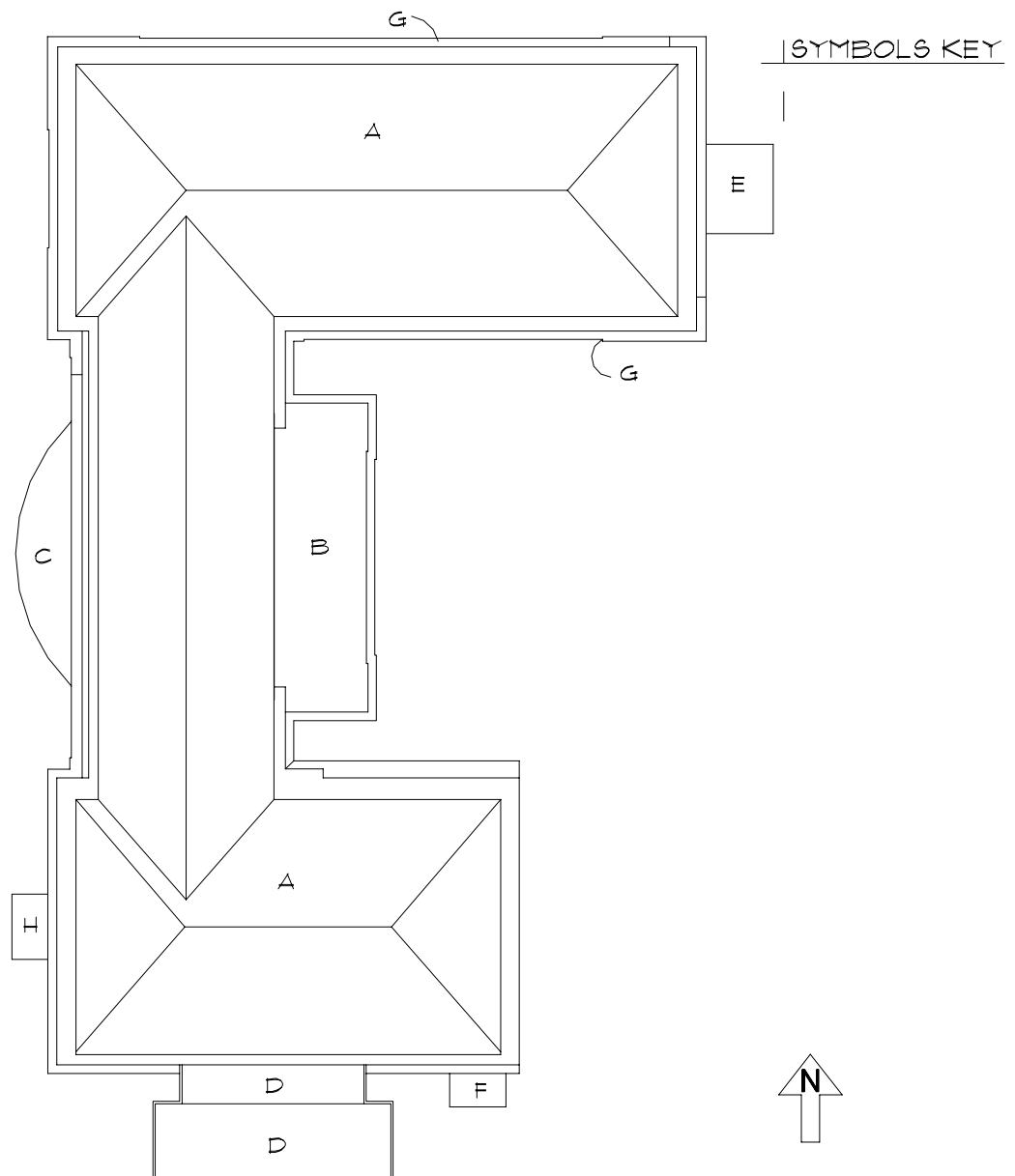

Roof Corrective Action

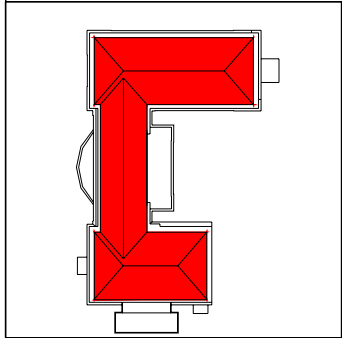
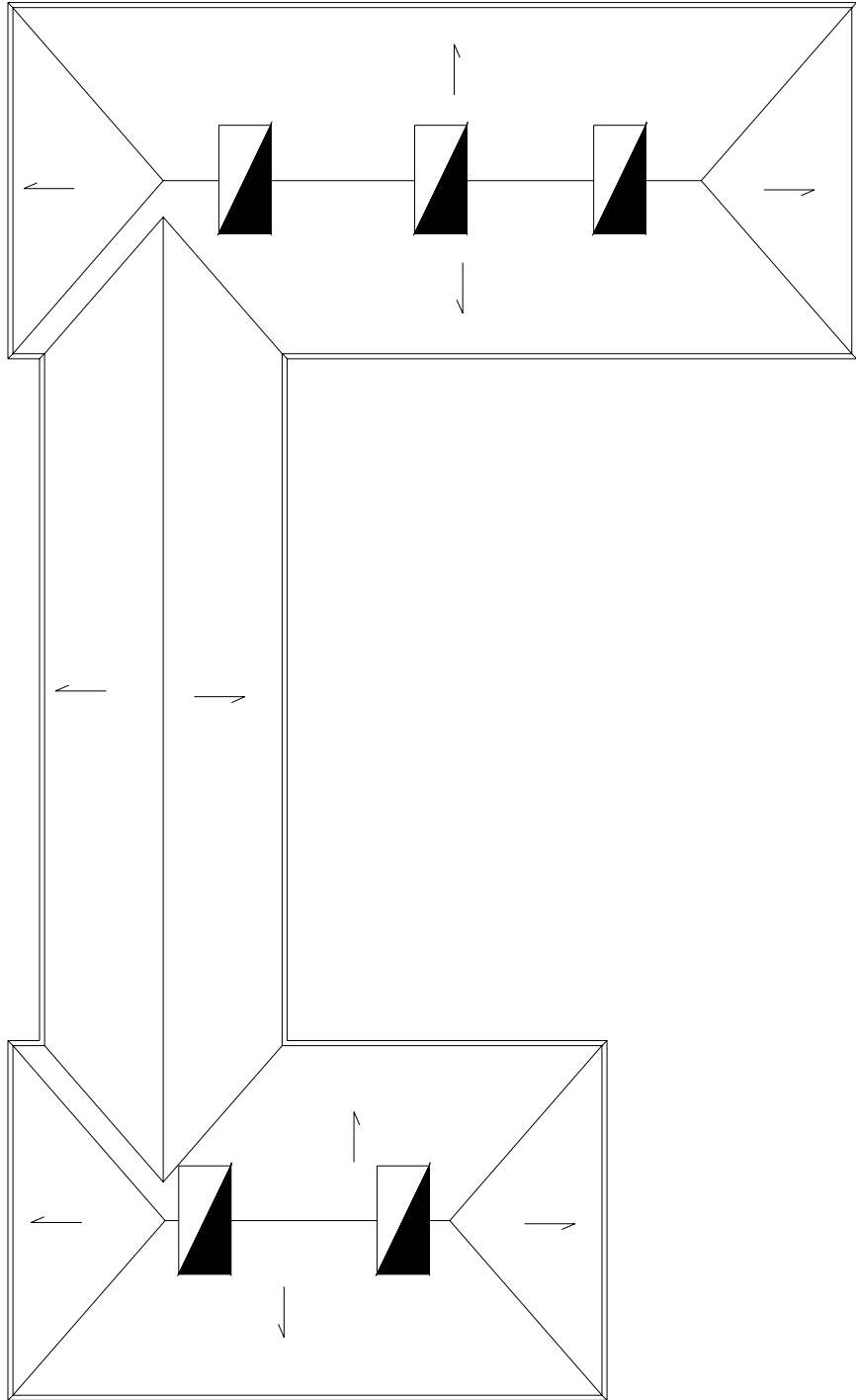

- SYMBOLS KEY**
- ↗ SLOPE DIRECTION
 - ROOF CURB
 - CHIMNEY

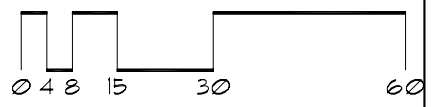

Roof Corrective Action

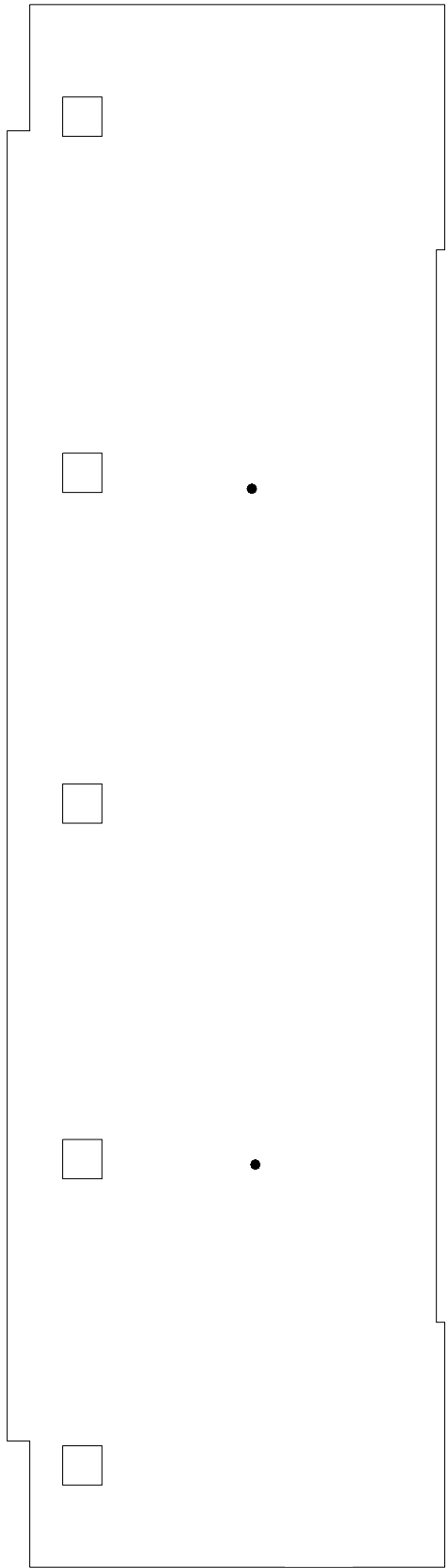

SYMBOLS KEY

- POSTS
- ROOF DRAIN
- ① DEFECT-NO REPAIR

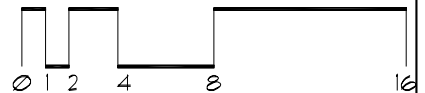
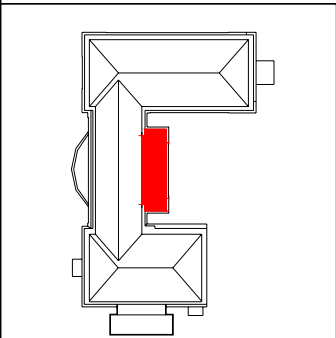

Roof Corrective Action

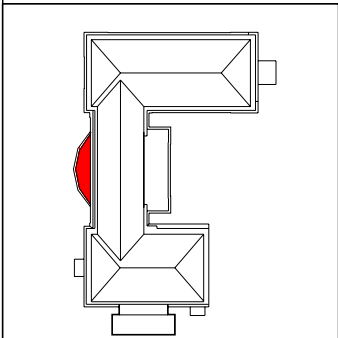
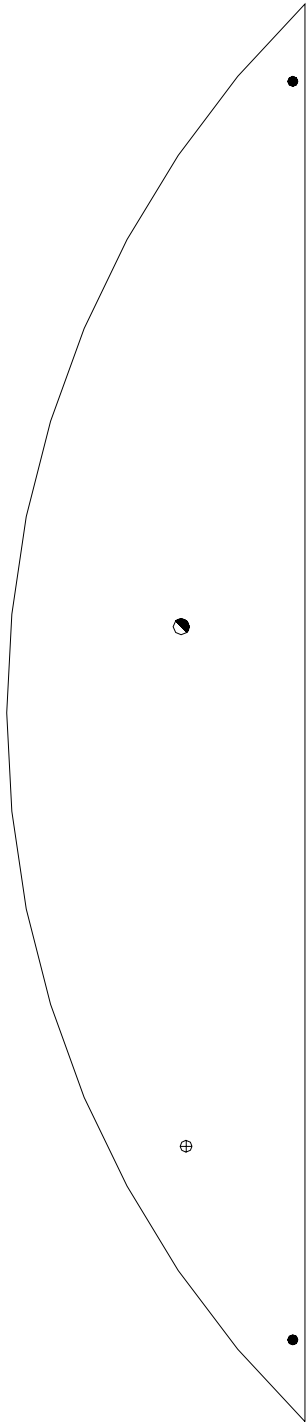

SYMBOLS KEY

- ROOF DRAIN
- ⊕ PIPE PENETRATION
- ⊘ HEAT STACK

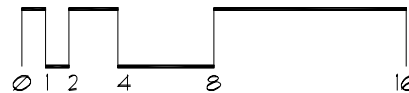

Roof Corrective Action

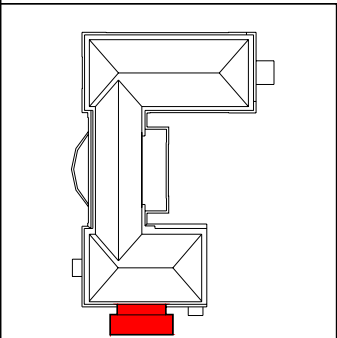
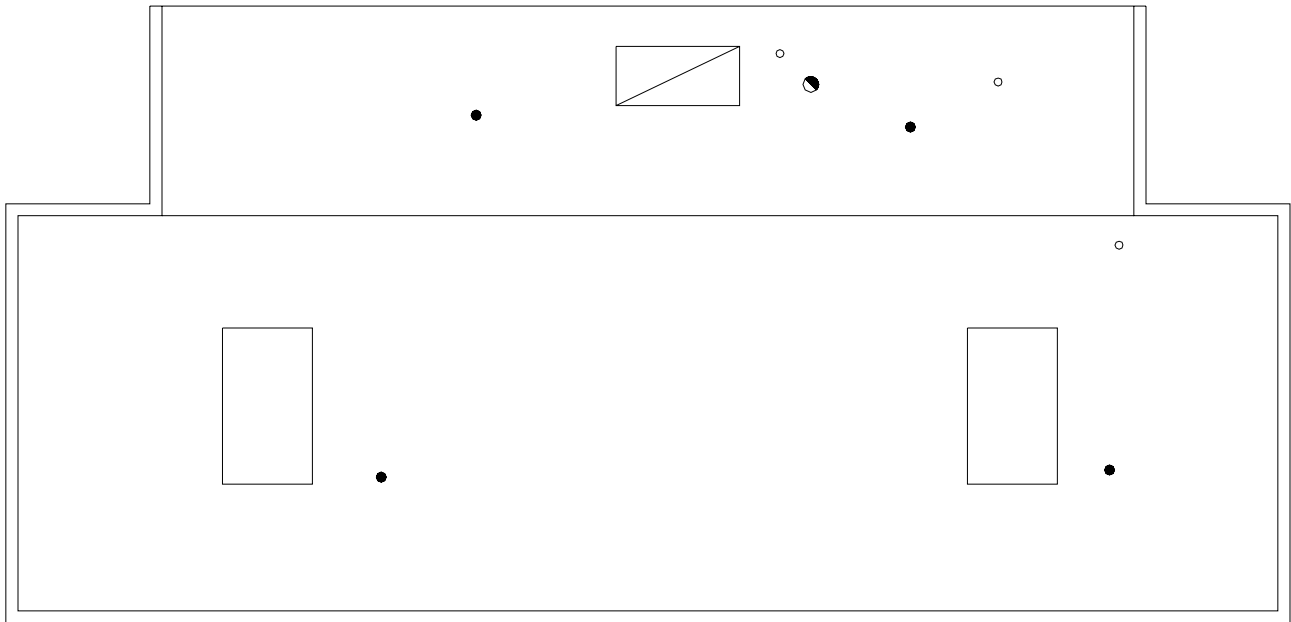

SYMBOLS KEY

- ROOF CURB
- ROOF DRAIN
- VENT STACK
- ▣ ROOF HATCH
- (with dot) HEAT STACK

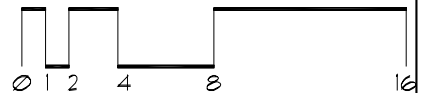

Roof Corrective Action

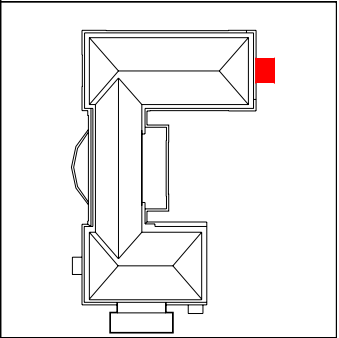
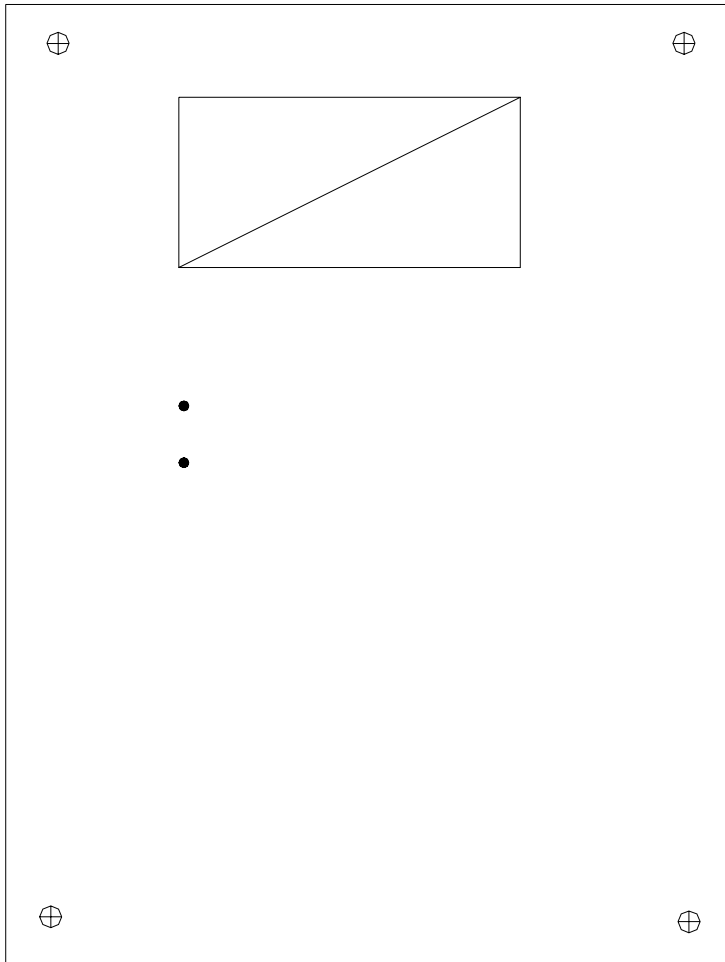

- SYMBOLS KEY
- ROOF DRAIN
 - ⊕ PIPE PENETRATION
 - ☒ ROOF HATCH
 - ⓪ DEFECT-NO REPAIR

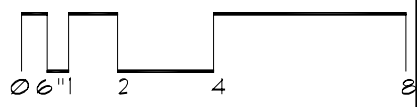

Roof Corrective Action

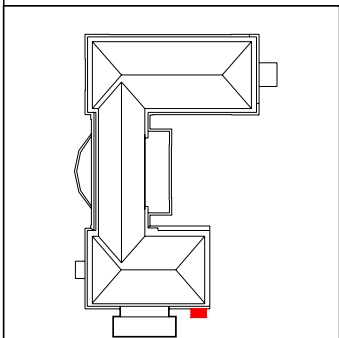
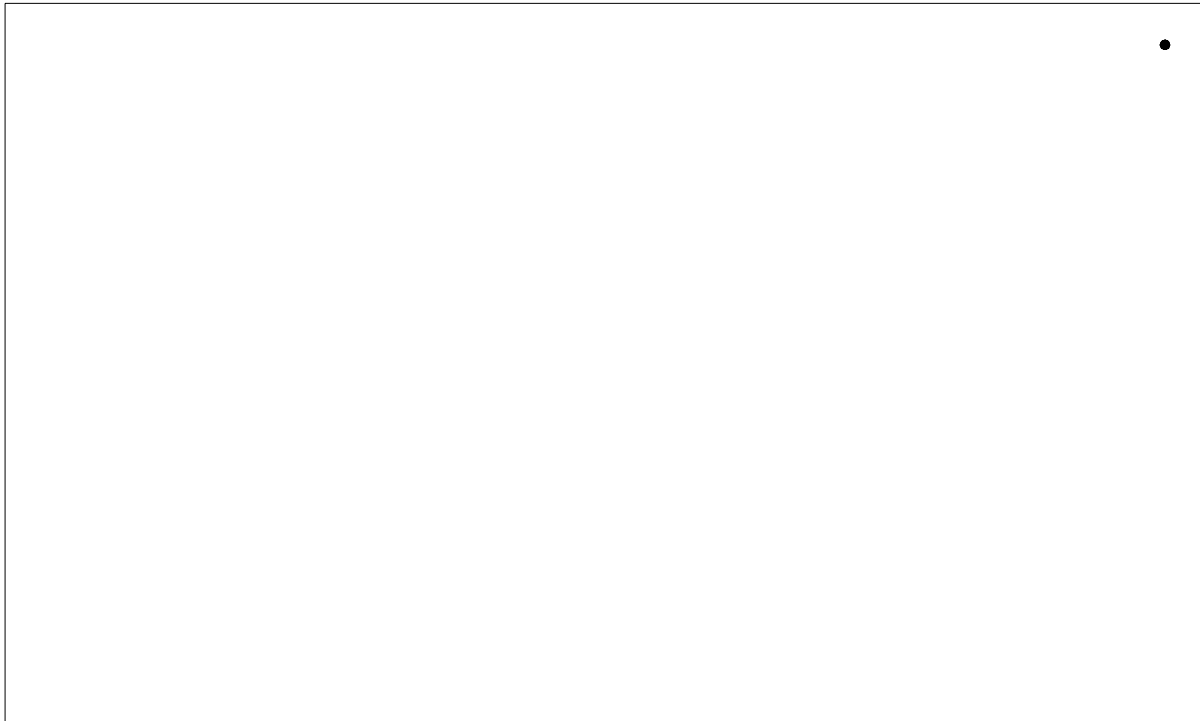

SYMBOLS KEY
● ROOF DRAIN
Ⓢ DEFECT-REPAIR

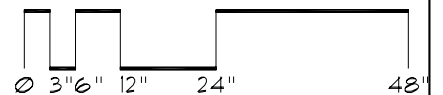

Roof Corrective Action

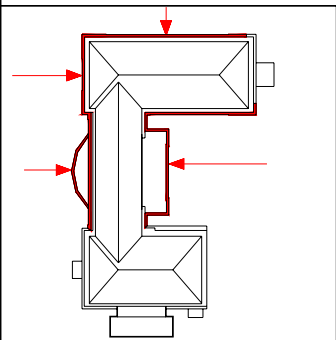
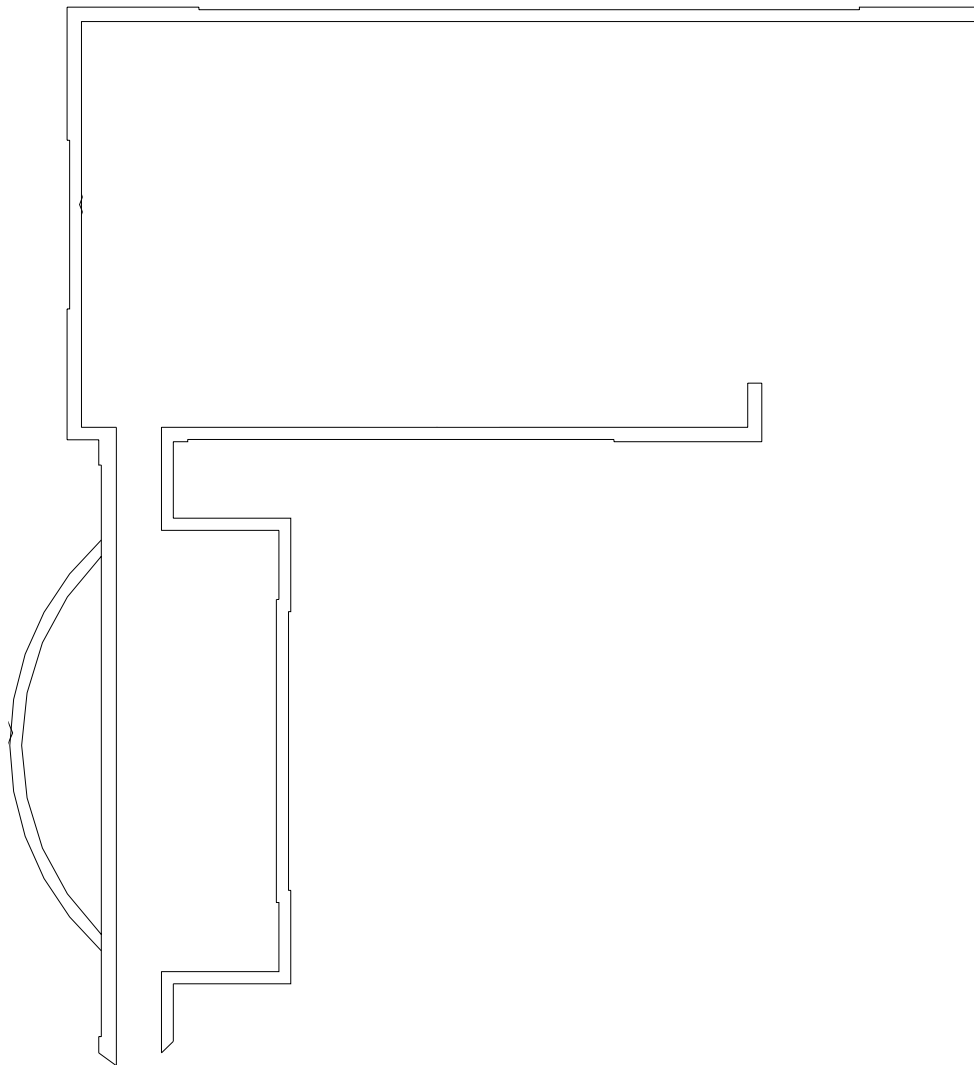

SYMBOLS KEY
① DEFECT-NO REPAIR

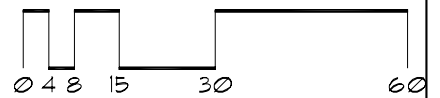

Roof Corrective Action

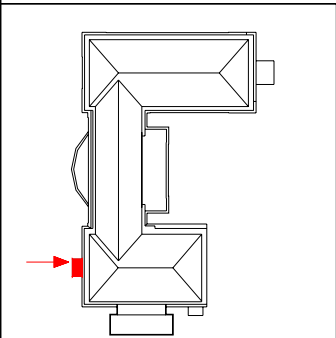
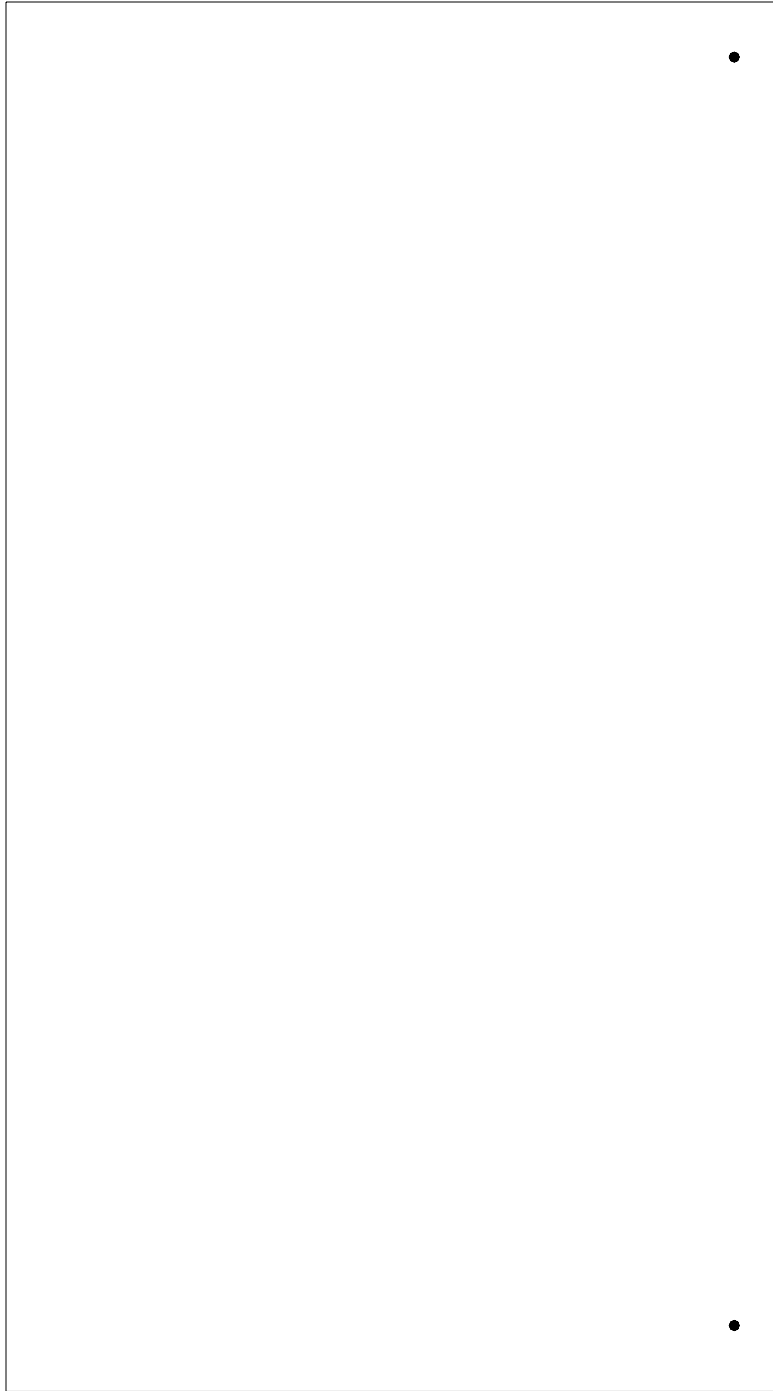

SYMBOLS KEY
● ROOF DRAIN
Ⓢ DEFECT-REPAIR

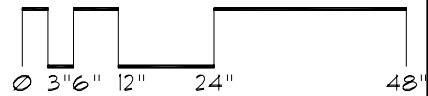

Roof ID

Building: HS069 - Variety Club Research Ctr. - (425 East River Road Minneapolis)

Total Area: 22,741 sf

A	3,687 sf	E	162 sf	I	2,508 sf	M	600 sf	Q	414 sf
B	1,440 sf	F	1,916 sf	J	416 sf	N	1,200 sf		
C	270 sf	G	81 sf	K	3,159 sf	O	2,680 sf		
D	1,468 sf	H	190 sf	L	1,110 sf	P	1,440 sf		

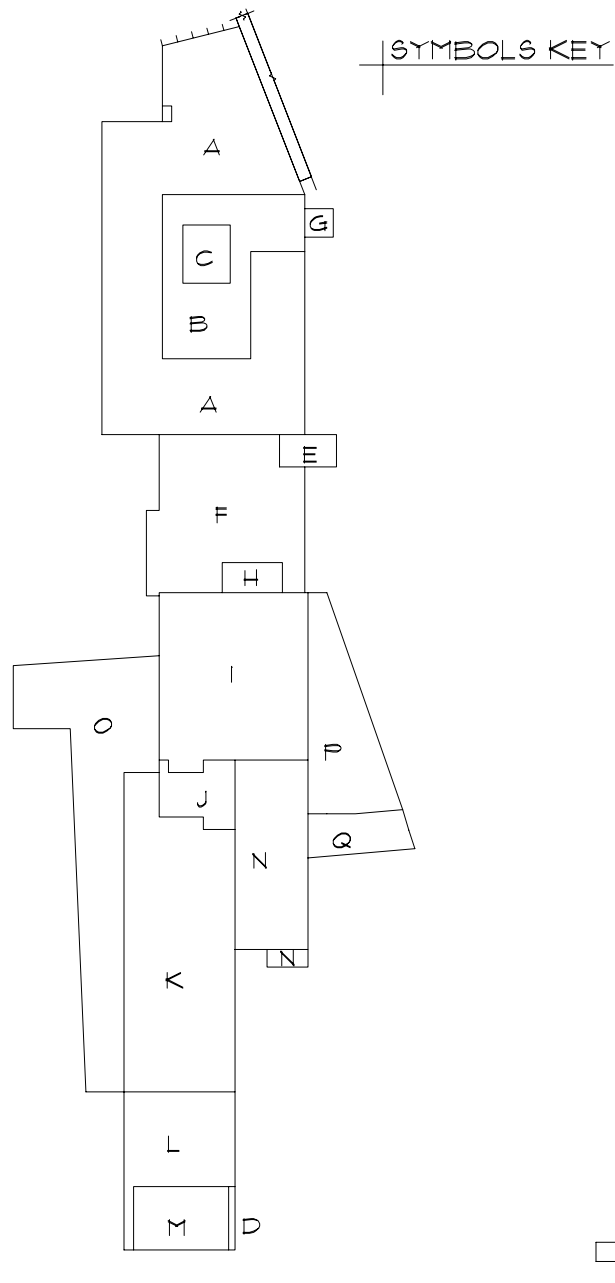

Roof Corrective Action



SYMBOLS KEY

- VENT STACK
- ROOF DRAIN
- ROOF CURB
- ▬ SLEEPER CURB
- ⊞ OBSOLETE SLEEPER CURB
- Ⓢ DEFECT-REPAIR
- Ⓣ DEFECT-NO REPAIR

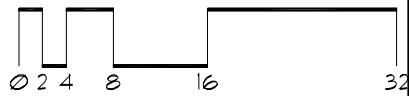
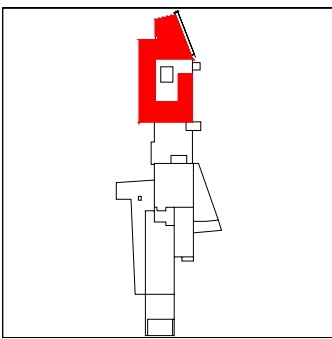

Roof Corrective Action

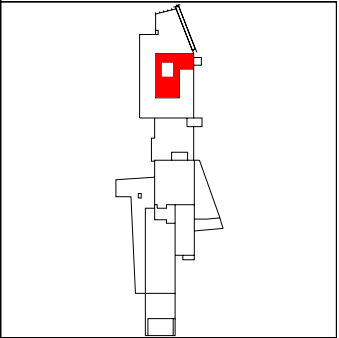
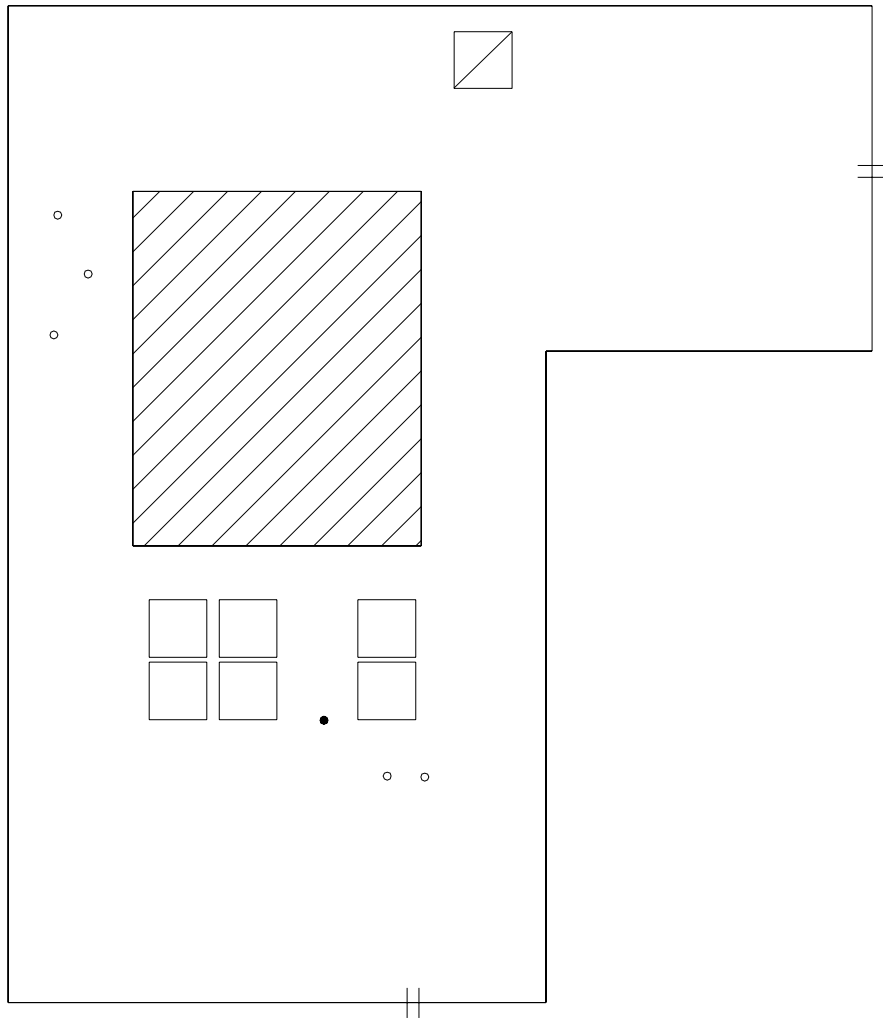

SYMBOLS KEY

⊥	SCUPPER
○	VENT STACK
●	ROOF DRAIN
□	ROOF CURB
▣	CHIMNEY
▨	ROOF HATCH
①	DEFECT-REPAIR
②	DEFECT-NO REPAIR

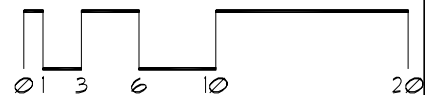

Roof Corrective Action

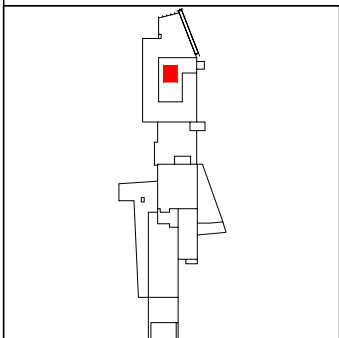
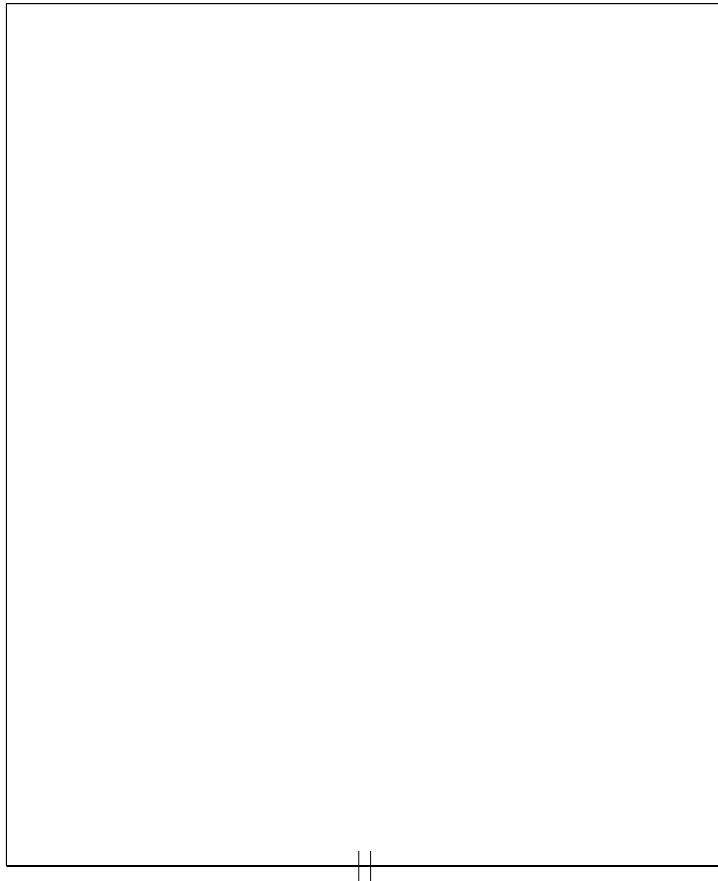

SYMBOLS KEY
|| SCUPPER
① DEFECT-NO REPAIR

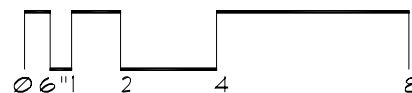
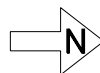

Roof Corrective Action

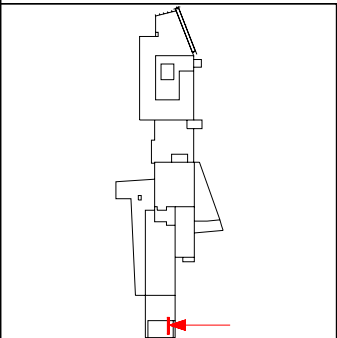

- SYMBOLS KEY**
- ⋈ SCUPPER
 - Ⓢ DEFECT-REPAIR
 - Ⓣ DEFECT-NO REPAIR

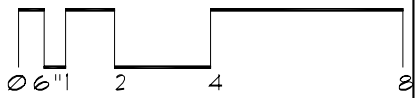

Roof Corrective Action

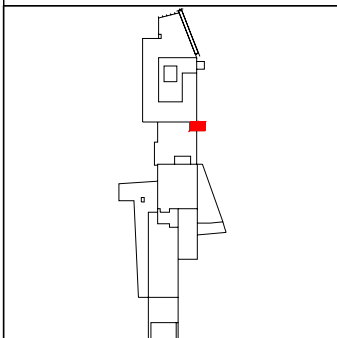
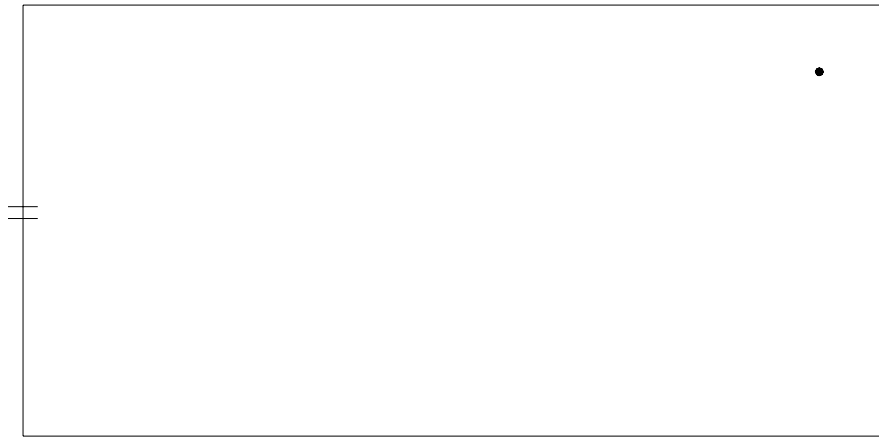

SYMBOLS KEY	
††	SCUPPER
•	ROOF DRAIN

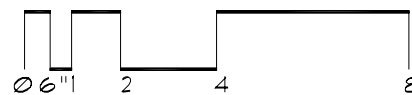

Roof Corrective Action

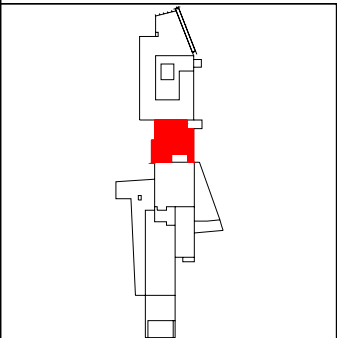
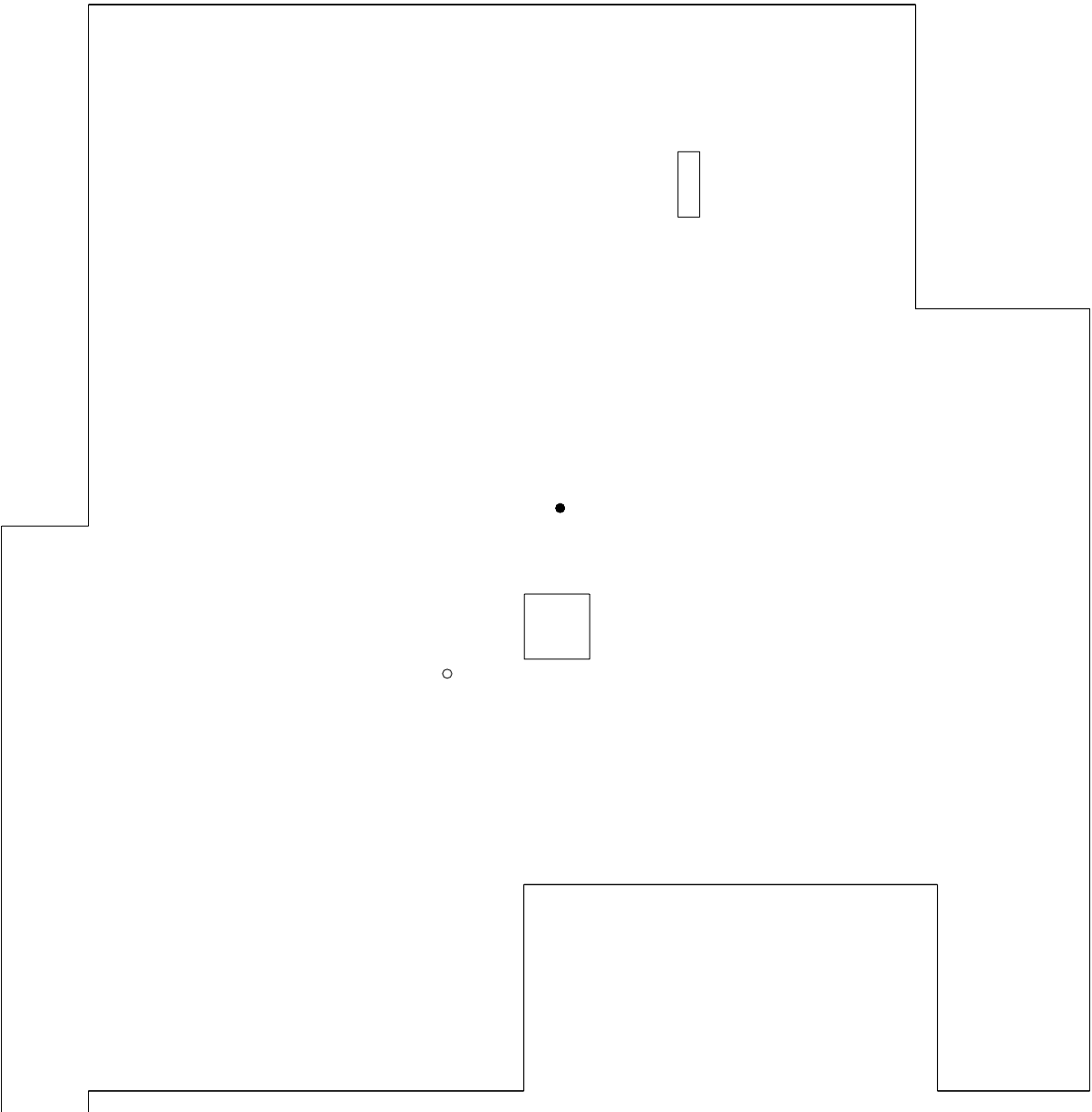

- SYMBOLS KEY**
- VENT STACK
 - ROOF DRAIN
 - ROOF CURB
 - ⊖ DEFECT-REPAIR
 - ⊕ DEFECT-NO REPAIR

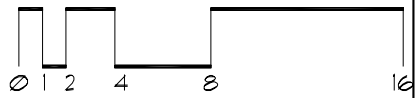

Roof Corrective Action

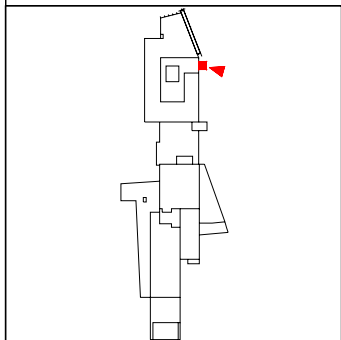
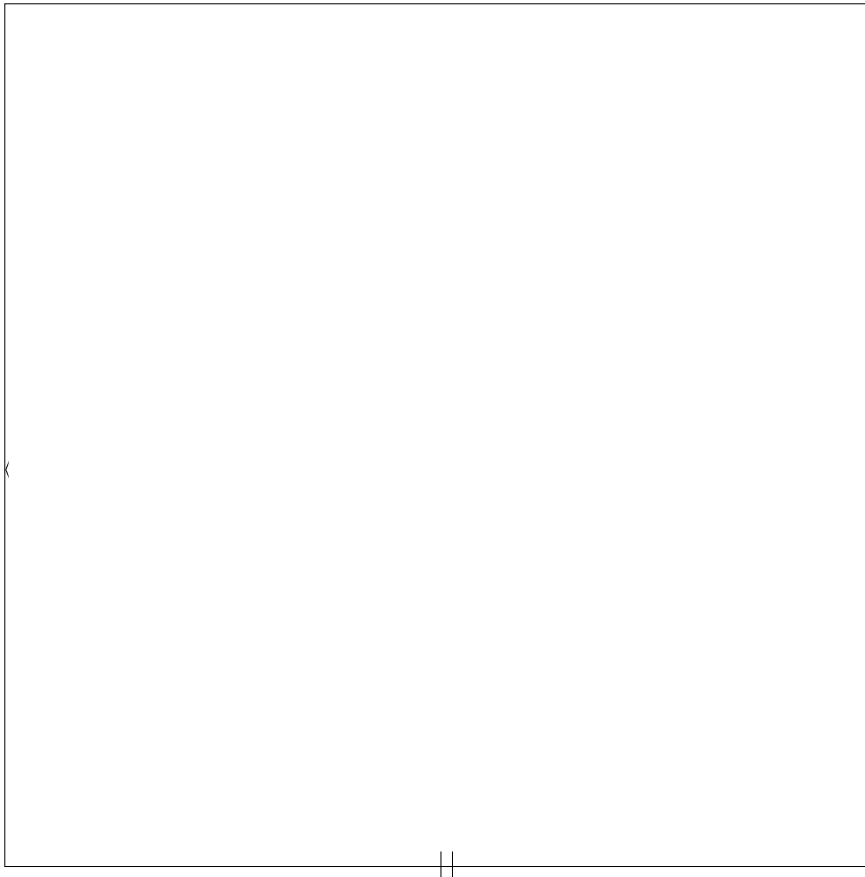

SYMBOLS KEY

†	SCUPPER
Ⓢ	DEFECT-REPAIR
Ⓣ	DEFECT-NO REPAIR

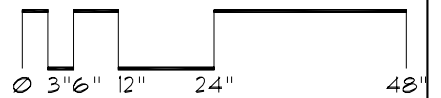

Roof Corrective Action

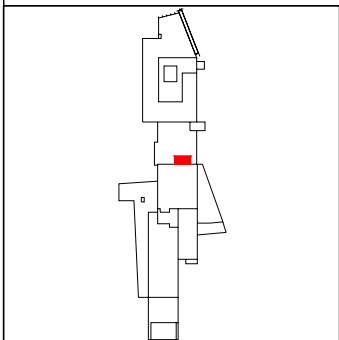
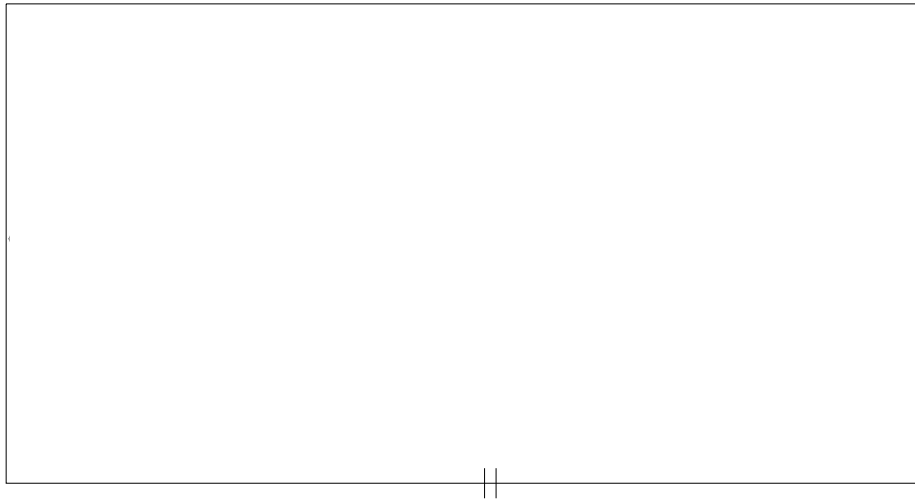

- SYMBOLS KEY
- ⦚ SCUPPER
 - Ⓢ DEFECT-REPAIR
 - ⓪ DEFECT-NO REPAIR

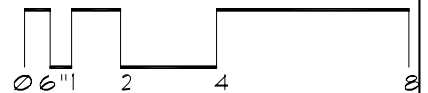

Roof Corrective Action

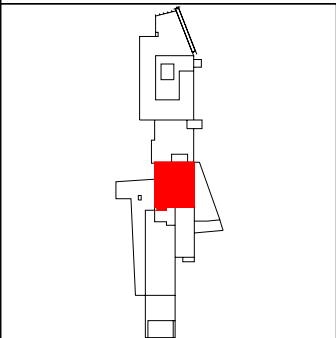
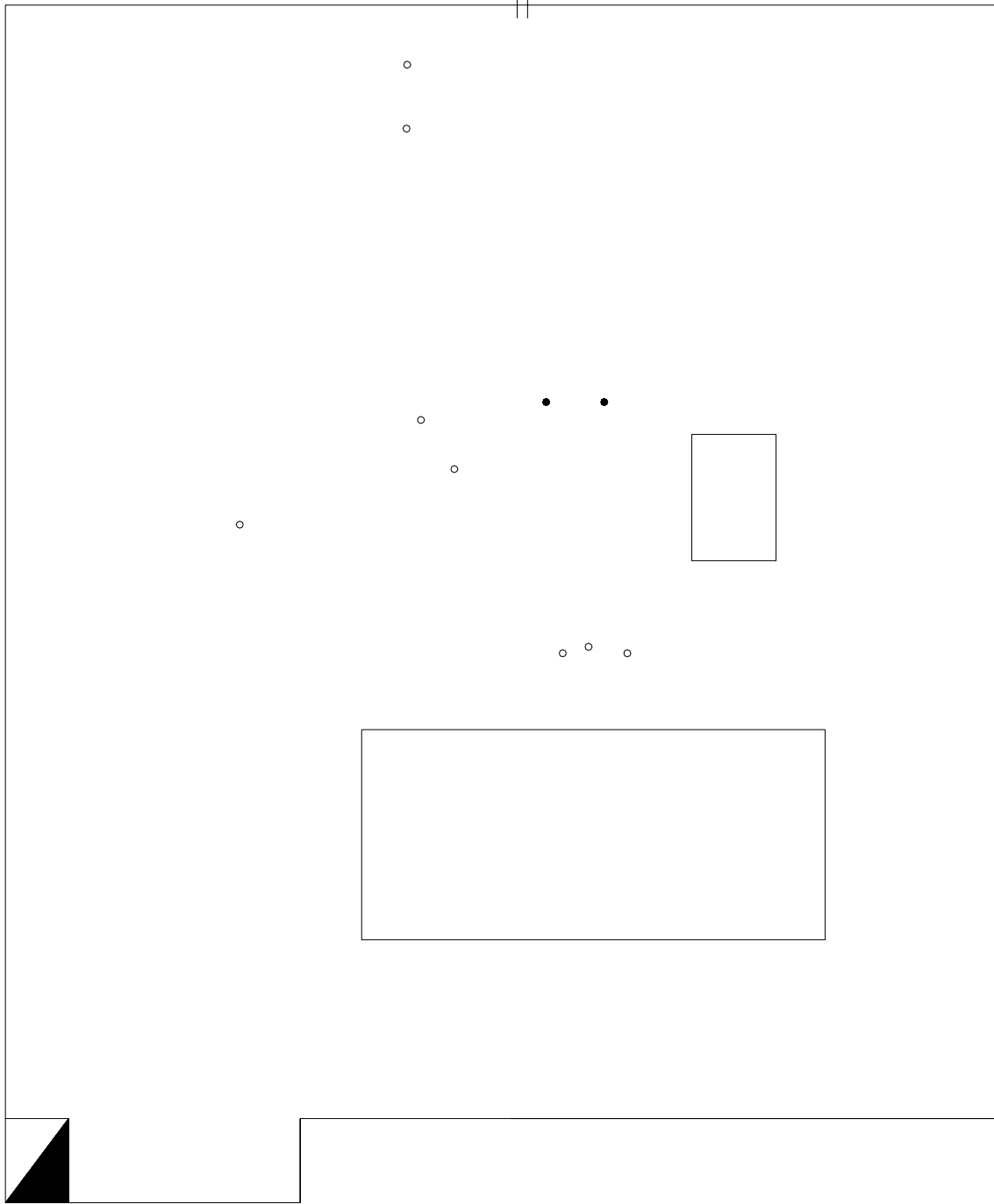

SYMBOLS KEY

- VENT STACK
- ROOF DRAIN
- ROOF CURB
- ⊖ DEFECT-REPAIR
- ⊕ DEFECT-NO REPAIR
- CHIMNEY

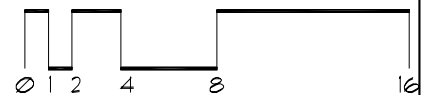
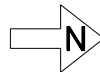

Roof Corrective Action

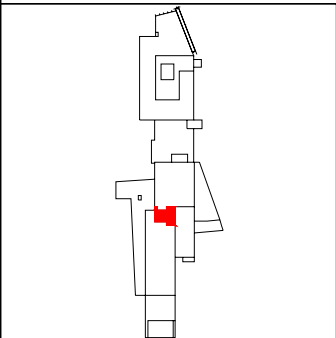
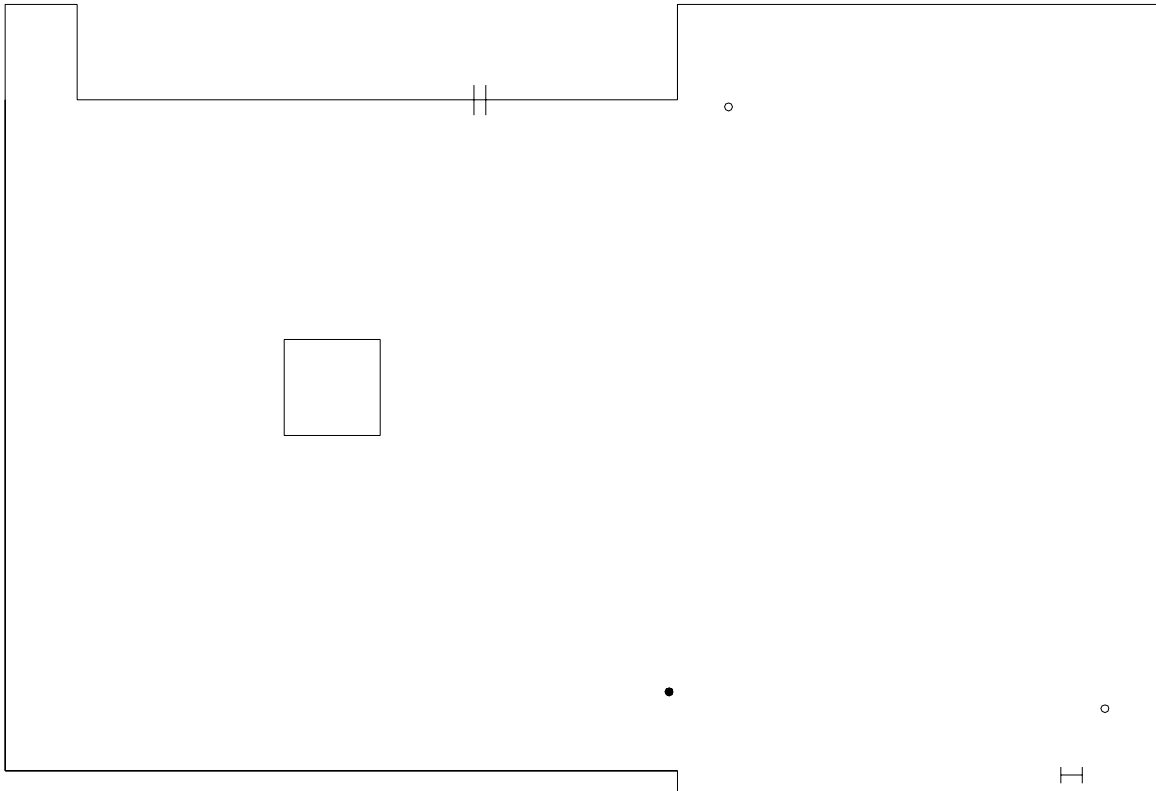

SYMBOLS KEY

- ⊥ SCUPPER
- VENT STACK
- ROOF DRAIN
- ROOF CURB
- I LADDER
- ① DEFECT-NO REPAIR

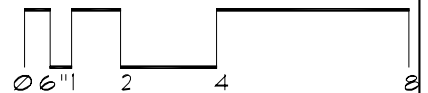

Roof Corrective Action

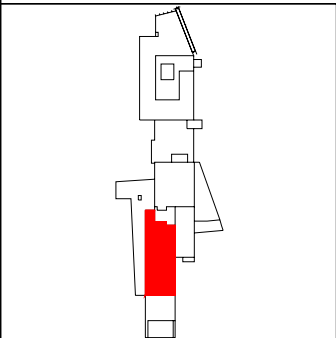
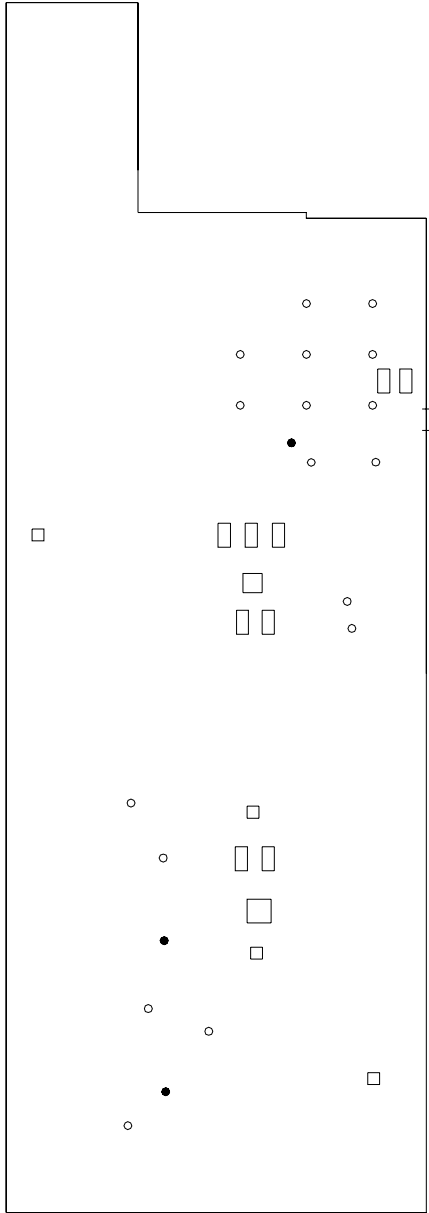

SYMBOLS KEY

- VENT STACK
- ROOF DRAIN
- ROOF CURB
- ▤ SLEEPER CURB
- ① DEFECT-NO REPAIR

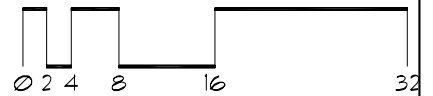

Roof Corrective Action

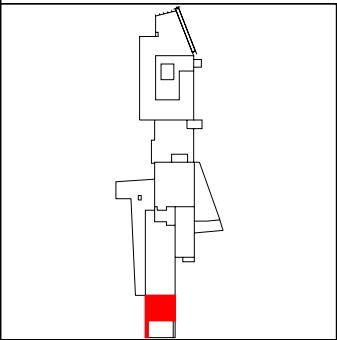
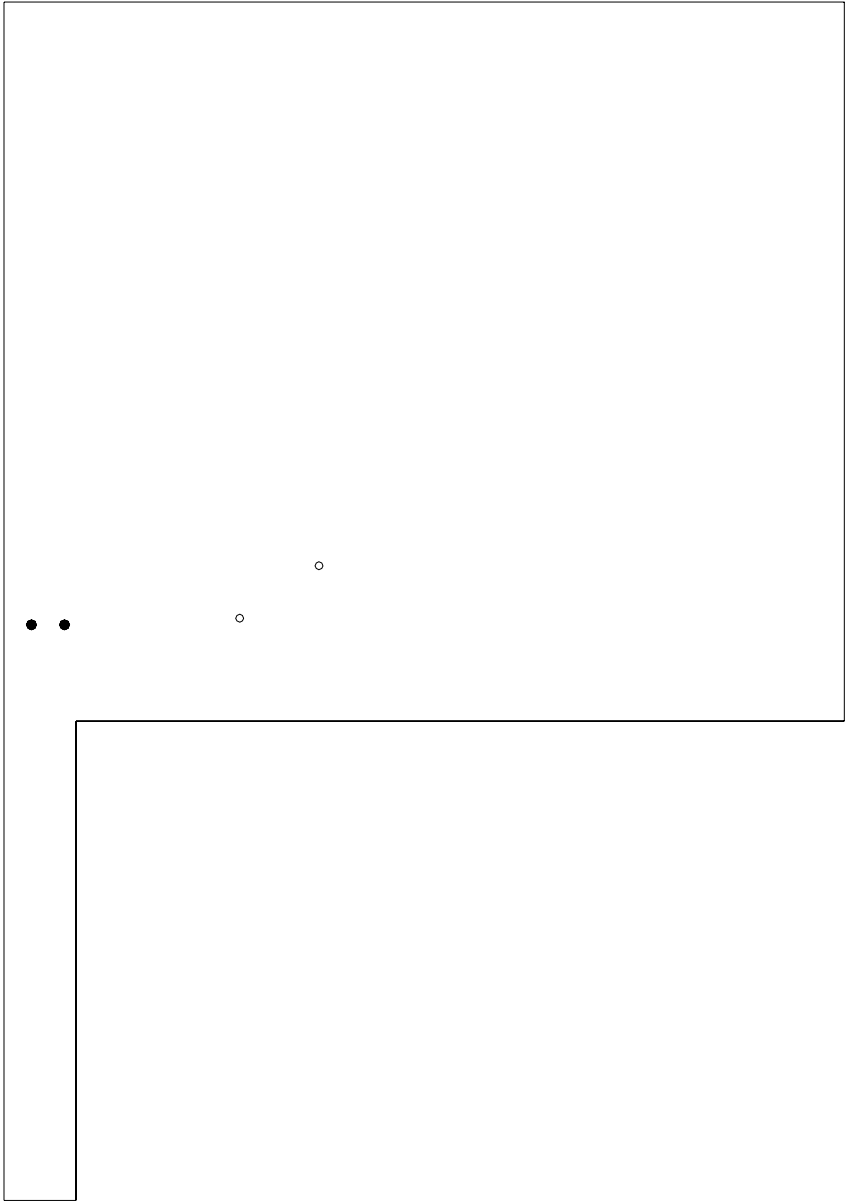

SYMBOLS KEY

- ROOF DRAIN
- VENT STACK

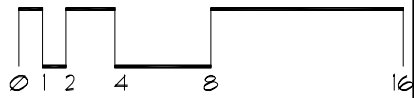

Roof Corrective Action

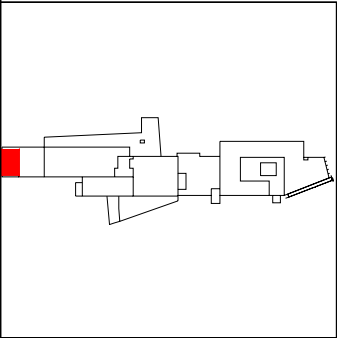
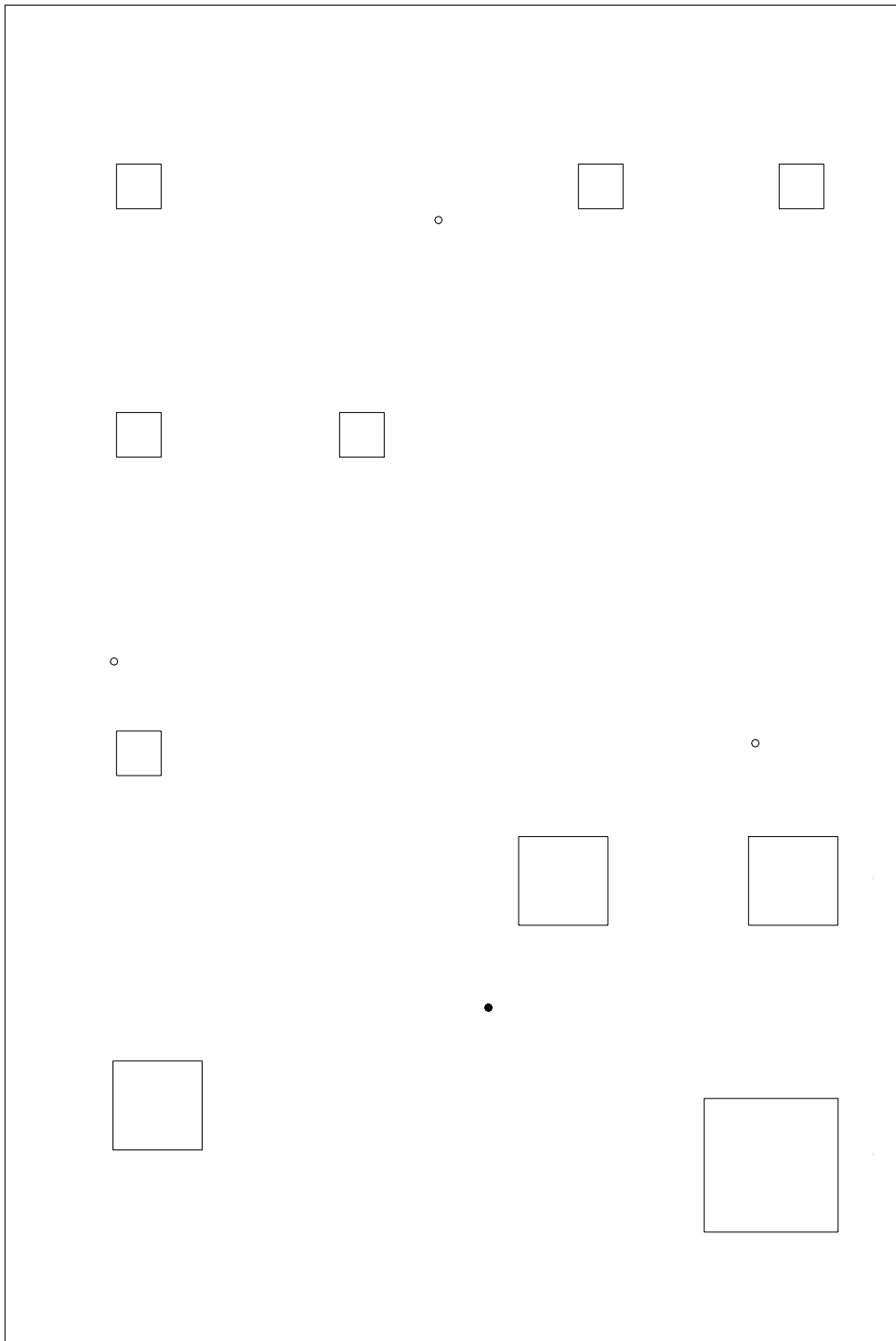

SYMBOLS KEY
● ROOF DRAIN
□ ROOF CURB

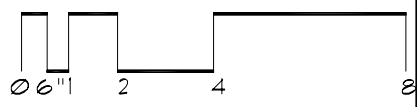
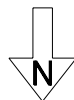

Roof Corrective Action

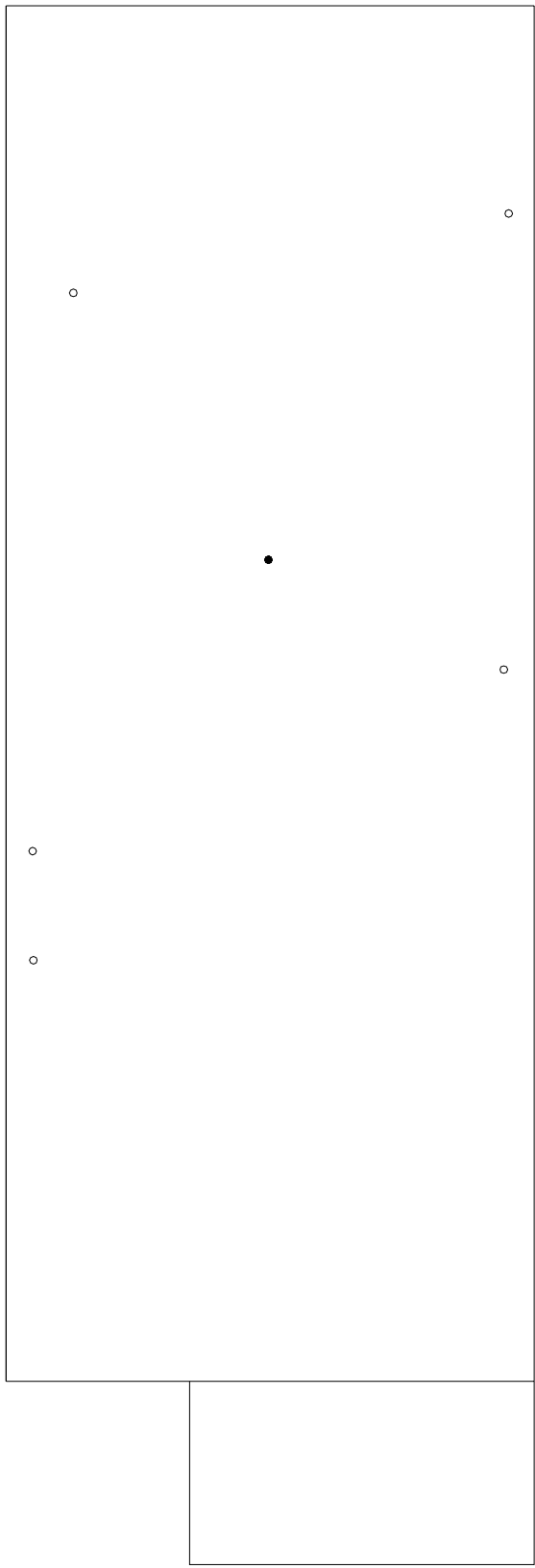

SYMBOLS KEY
○ VENT STACK
● ROOF DRAIN
H LADDER

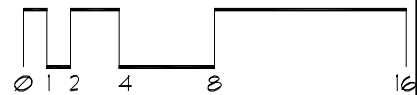
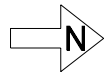
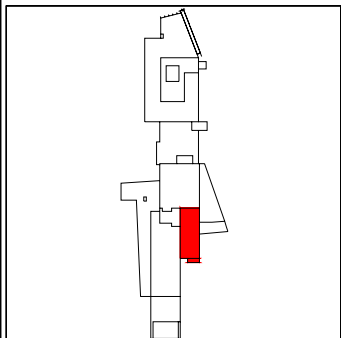

Roof Corrective Action

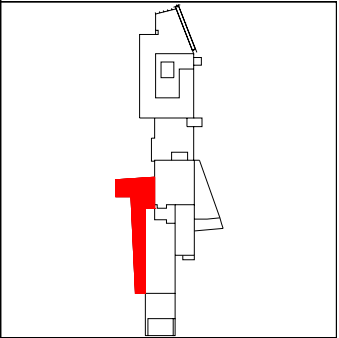
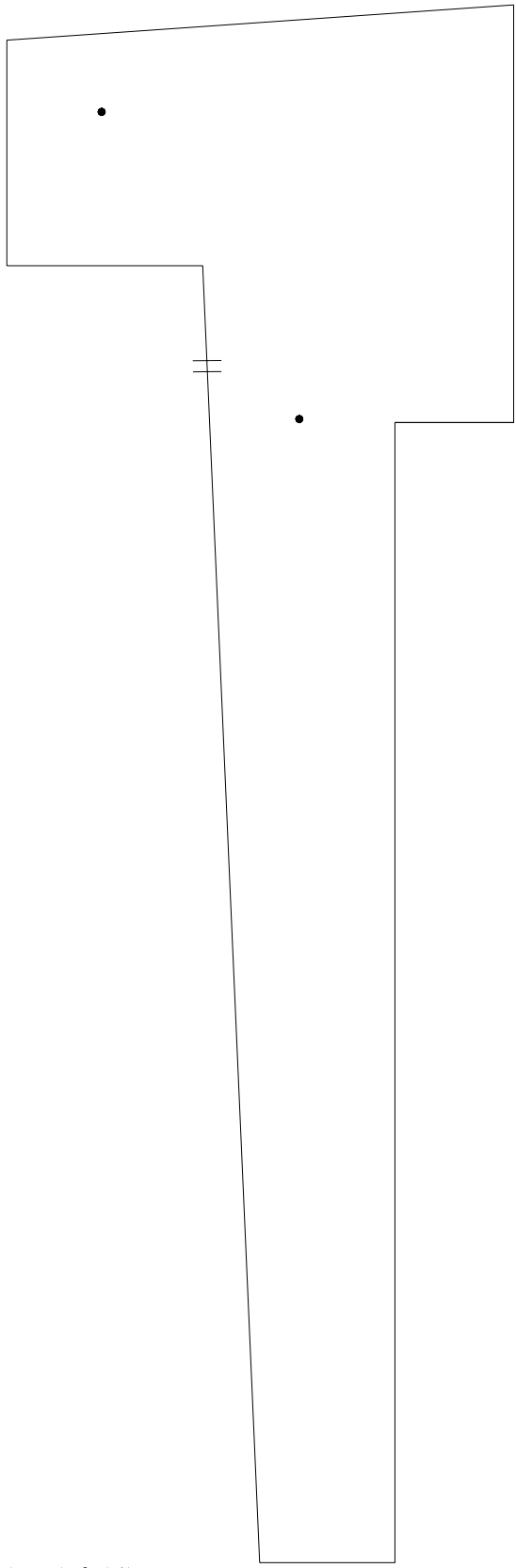

- SYMBOLS KEY
- || SCUPPER
 - ROOF DRAIN
 - Ⓢ DEFECT-REPAIR

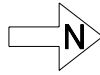

Roof Corrective Action

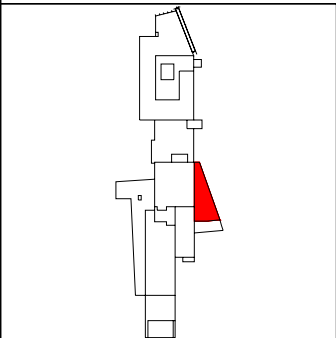
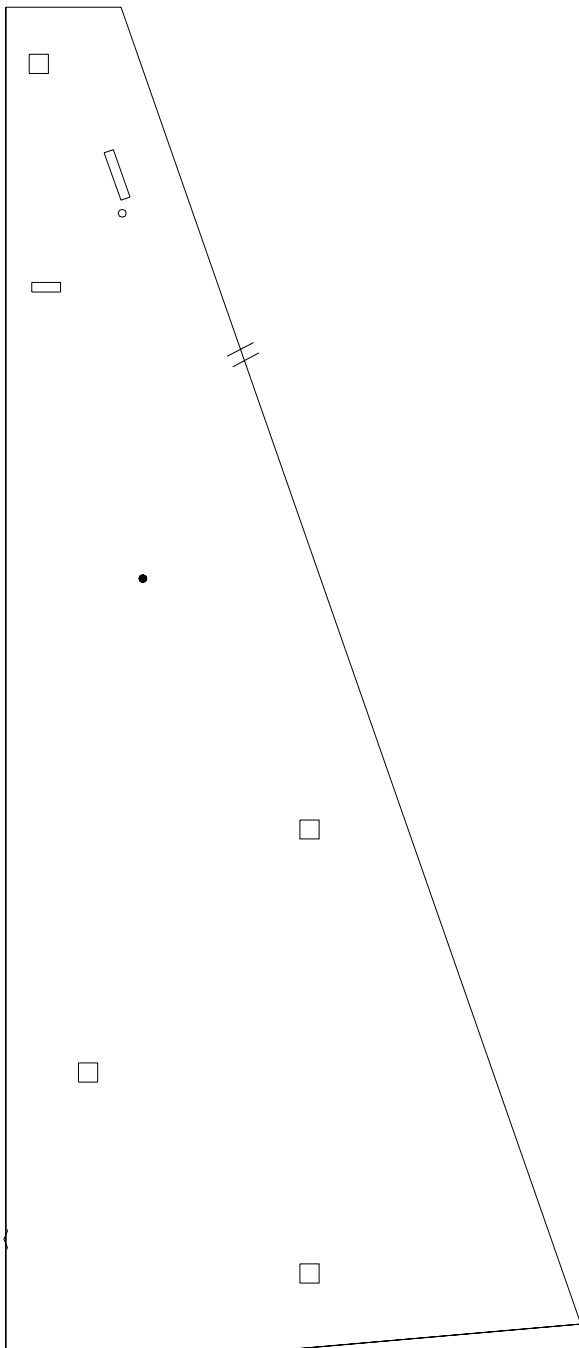

SYMBOLS KEY

- ⊥ SCUPPER
- VENT STACK
- ROOF DRAIN
- ROOF CURB
- Ⓢ DEFECT-REPAIR
- Ⓣ DEFECT-NO REPAIR

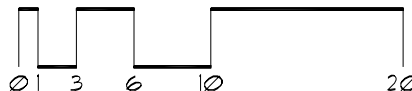

Roof Corrective Action

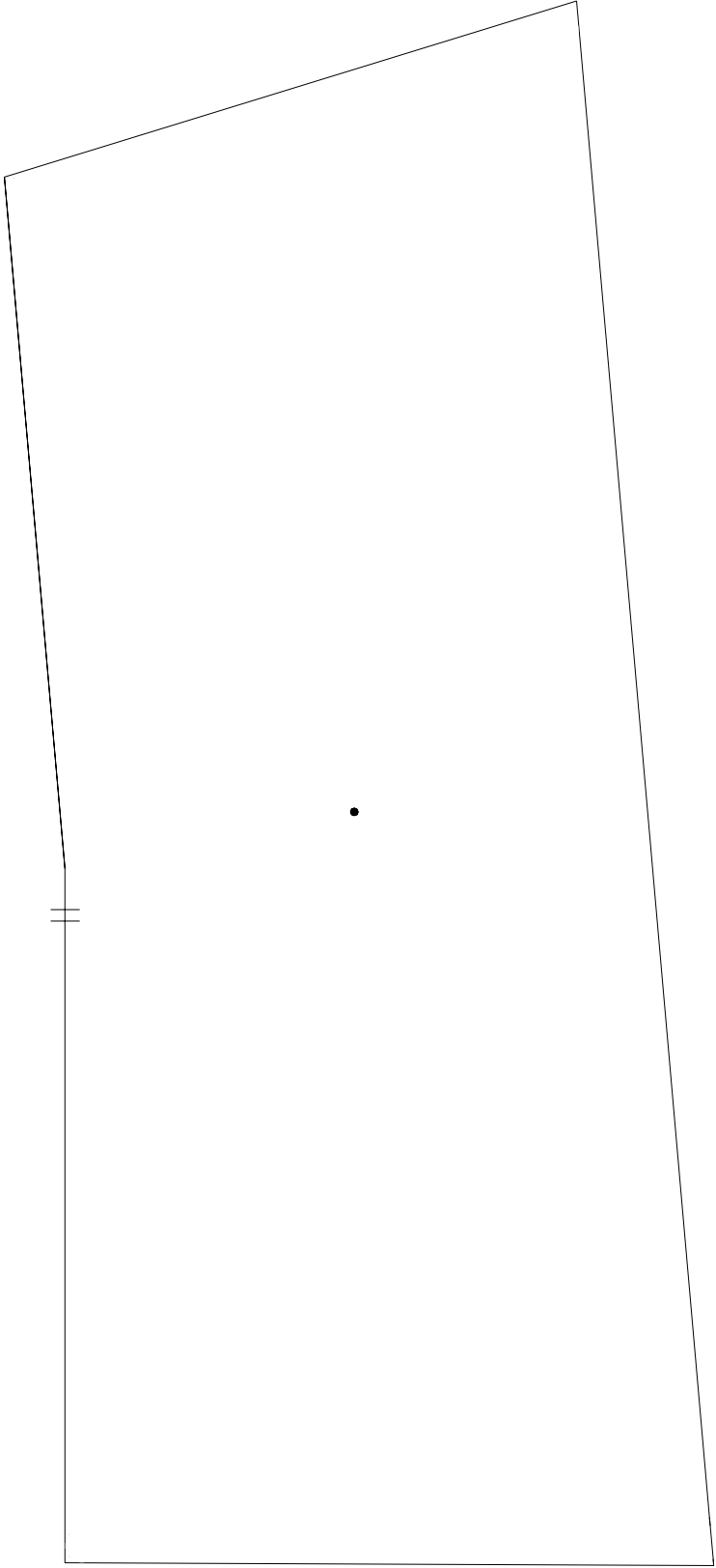

SYMBOLS KEY

- ROOF DRAIN
- ≡ SCUPPER

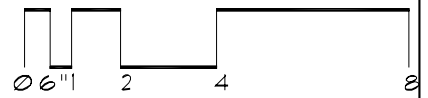
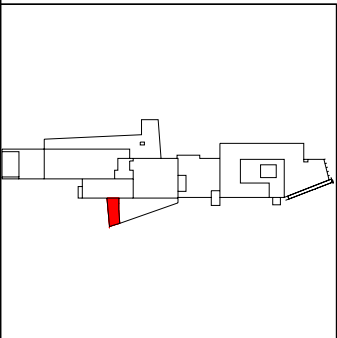

Roof ID

Building: HS070 - Boynton Health Services - (410 Church St. SE)

Total Area: 43,782 sf

A	7,685 sf	E	431 sf	I	9,459 sf	M	634 sf
B	1,138 sf	F	5,237 sf	J	950 sf	N	1,198 sf
C	475 sf	G	3,877 sf	K	9,409 sf	O	375 sf
D	262 sf	H	2,588 sf	L	64 sf		

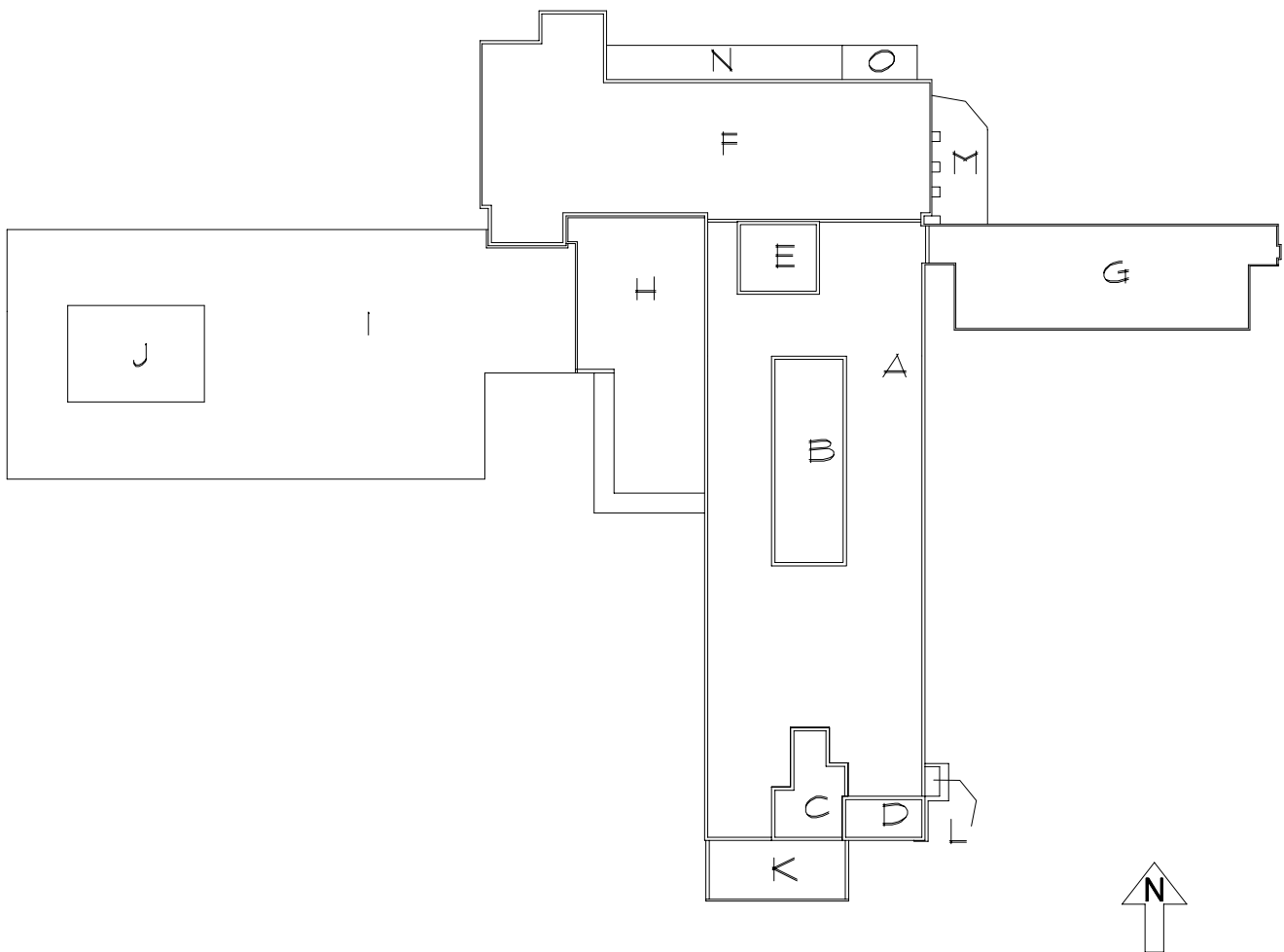

Roof Corrective Action

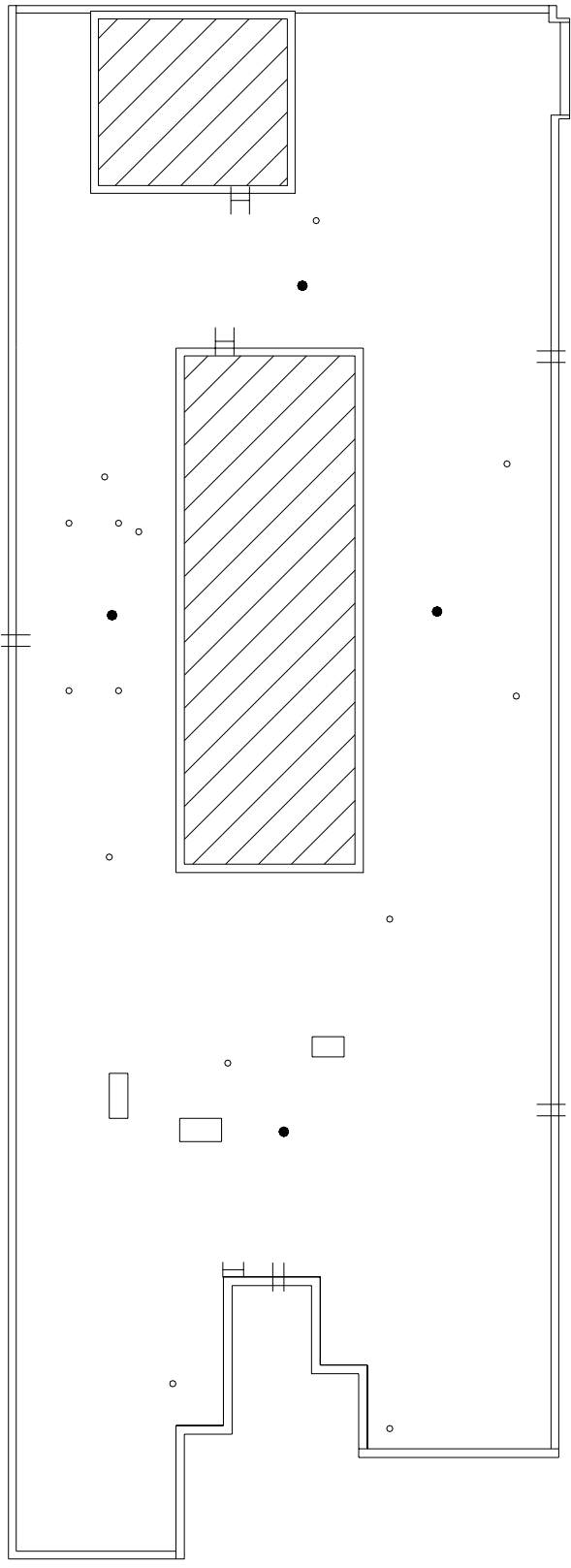

SYMBOLS KEY

- ROOF CURB
- ROOF DRAIN
- VENT STACK
- ⊕ SCUPPER
- I LADDER

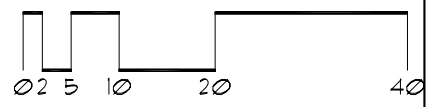
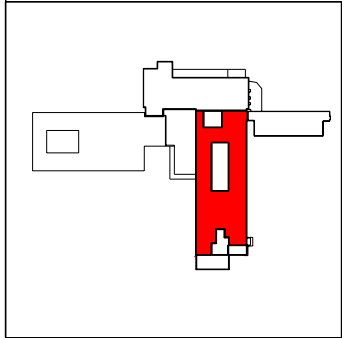

Roof Corrective Action

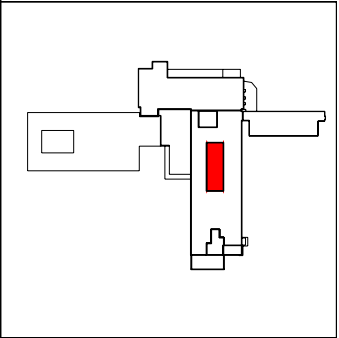
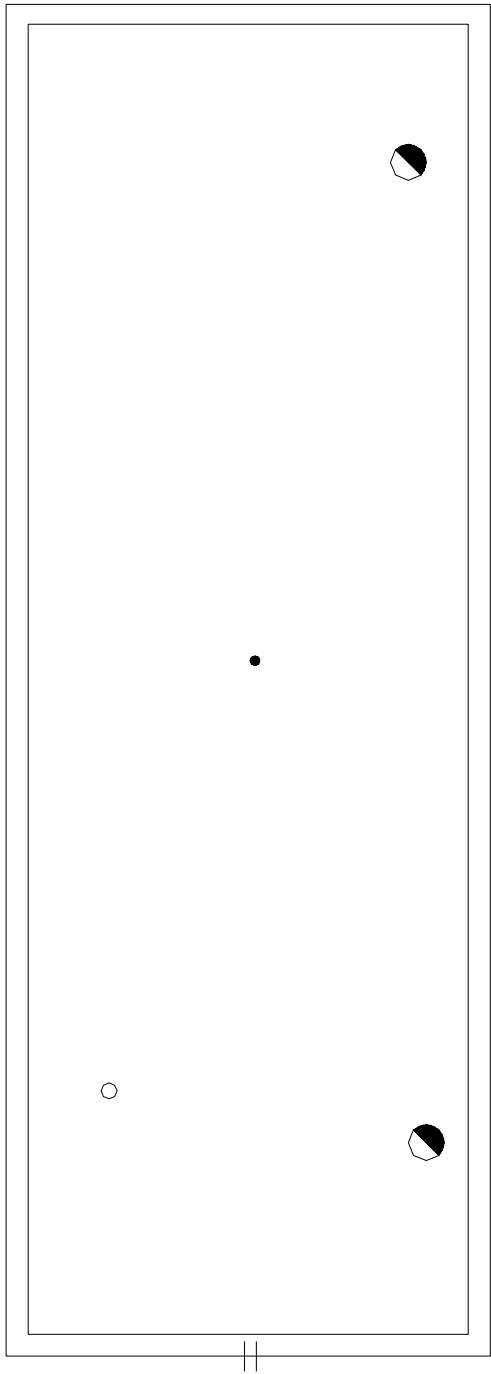

SYMBOLS KEY

- ROOF DRAIN
- VENT STACK
- ⊥ SCUPPER
- ◐ HEAT STACK

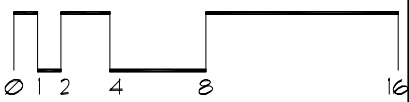

Roof Corrective Action

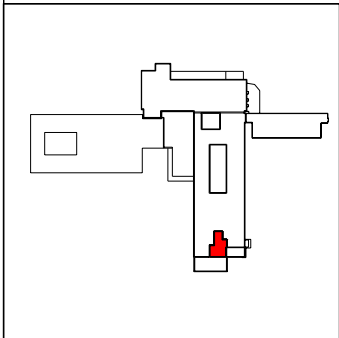
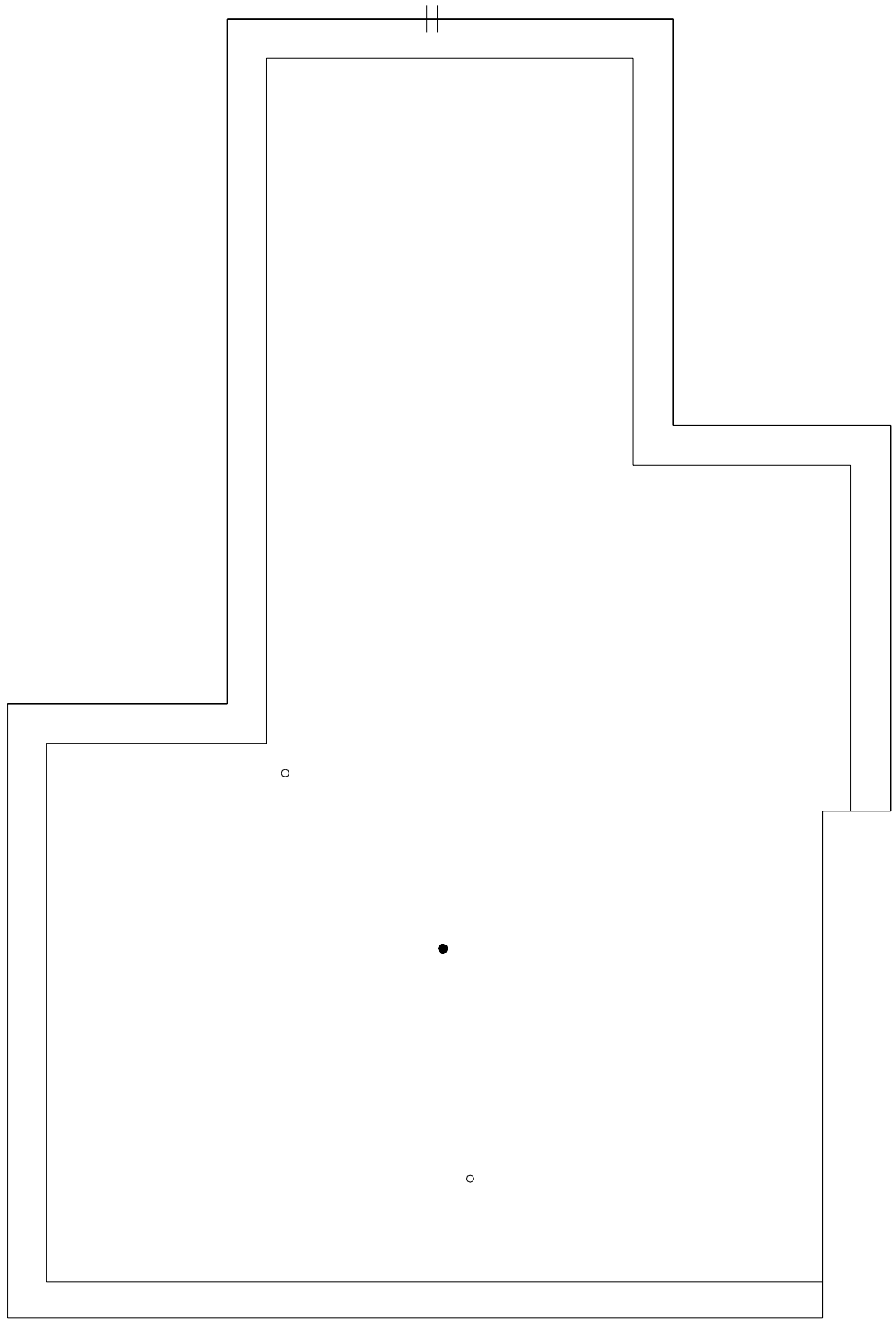

SYMBOLS KEY

- ROOF DRAIN
- VENT STACK
- ≡ SCUPPER

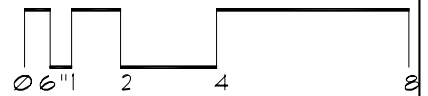

Roof Corrective Action

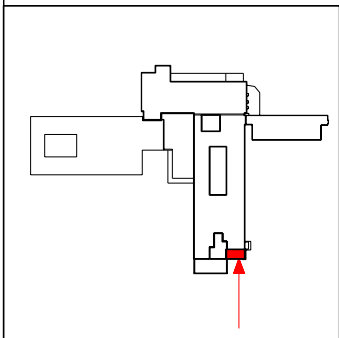

SYMBOLS KEY
|| SCUPPER

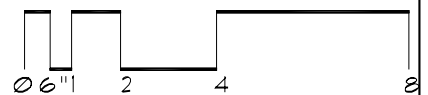

Roof Corrective Action

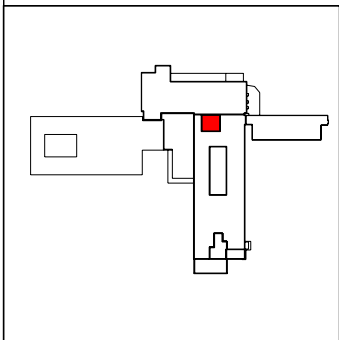

- SYMBOLS KEY
- ROOF DRAIN
 - VENT STACK
 - || SCUPPER

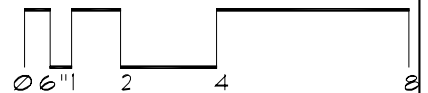

Roof Corrective Action

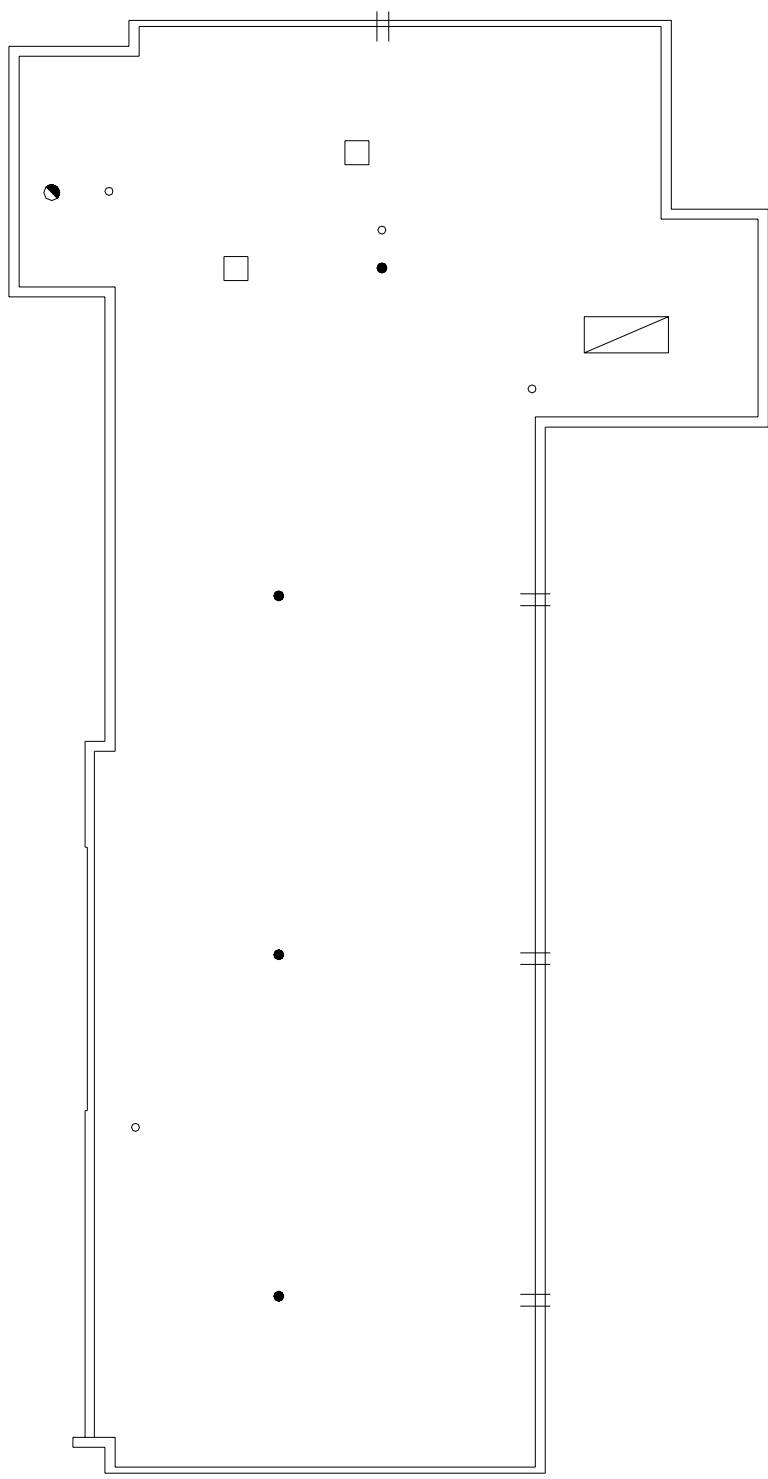

SYMBOLS KEY

□	ROOF CURB
●	ROOF DRAIN
○	VENT STACK
	SCUPPER
▣	ROOF HATCH
●	HEAT STACK

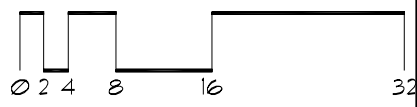
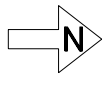
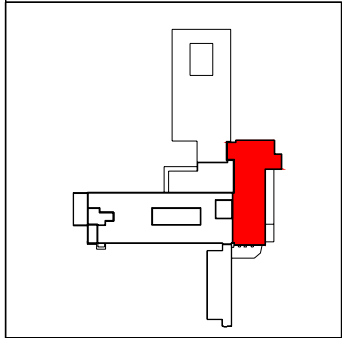

Roof Corrective Action

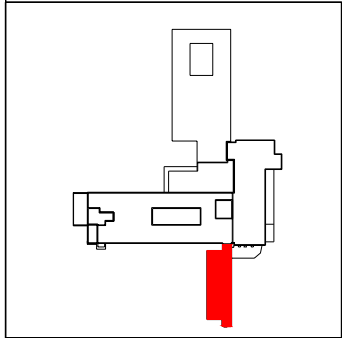
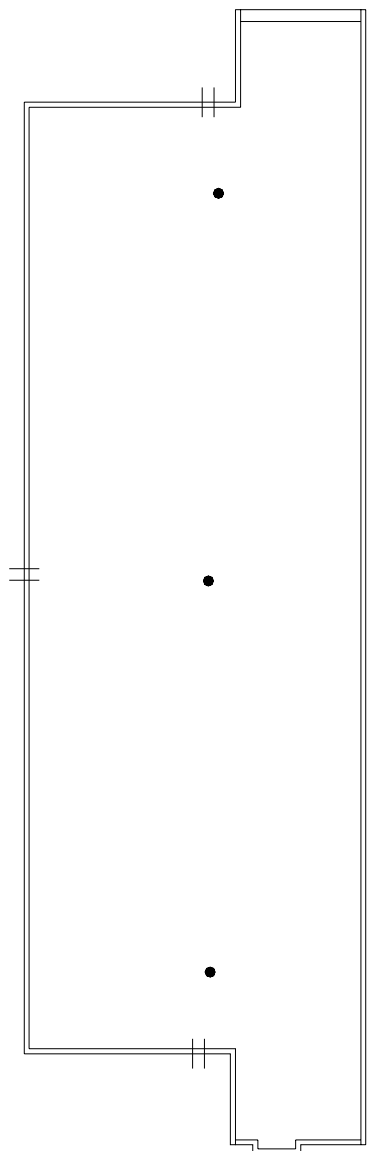

SYMBOLS KEY
● ROOF DRAIN
|| SCUPPER

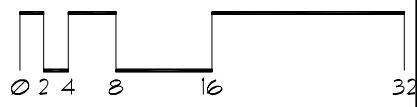
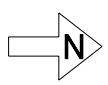

Roof Corrective Action

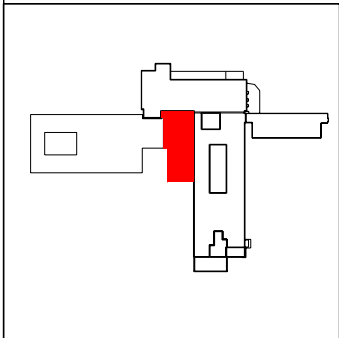
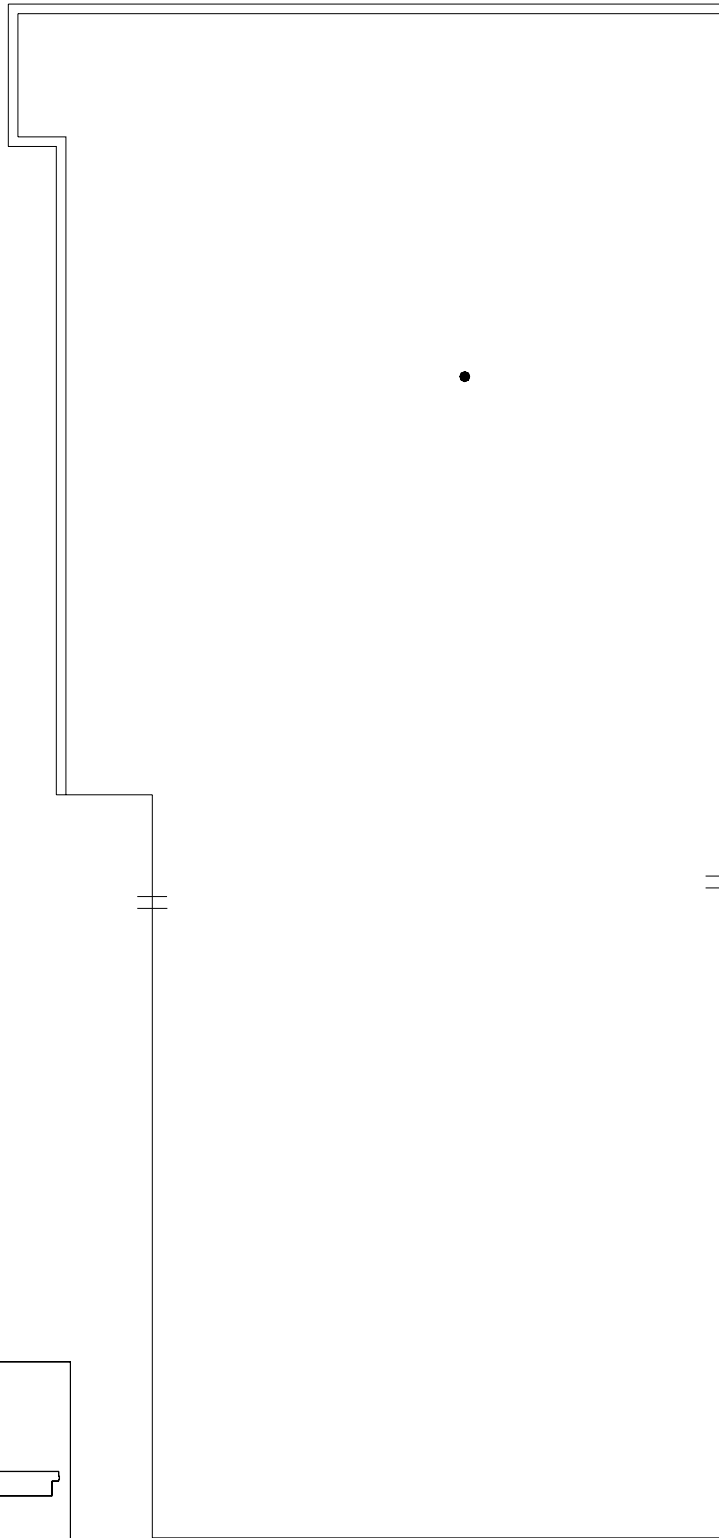

SYMBOLS KEY
†† SCUPPER
● ROOF DRAIN

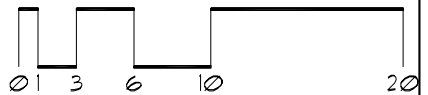

Roof Corrective Action

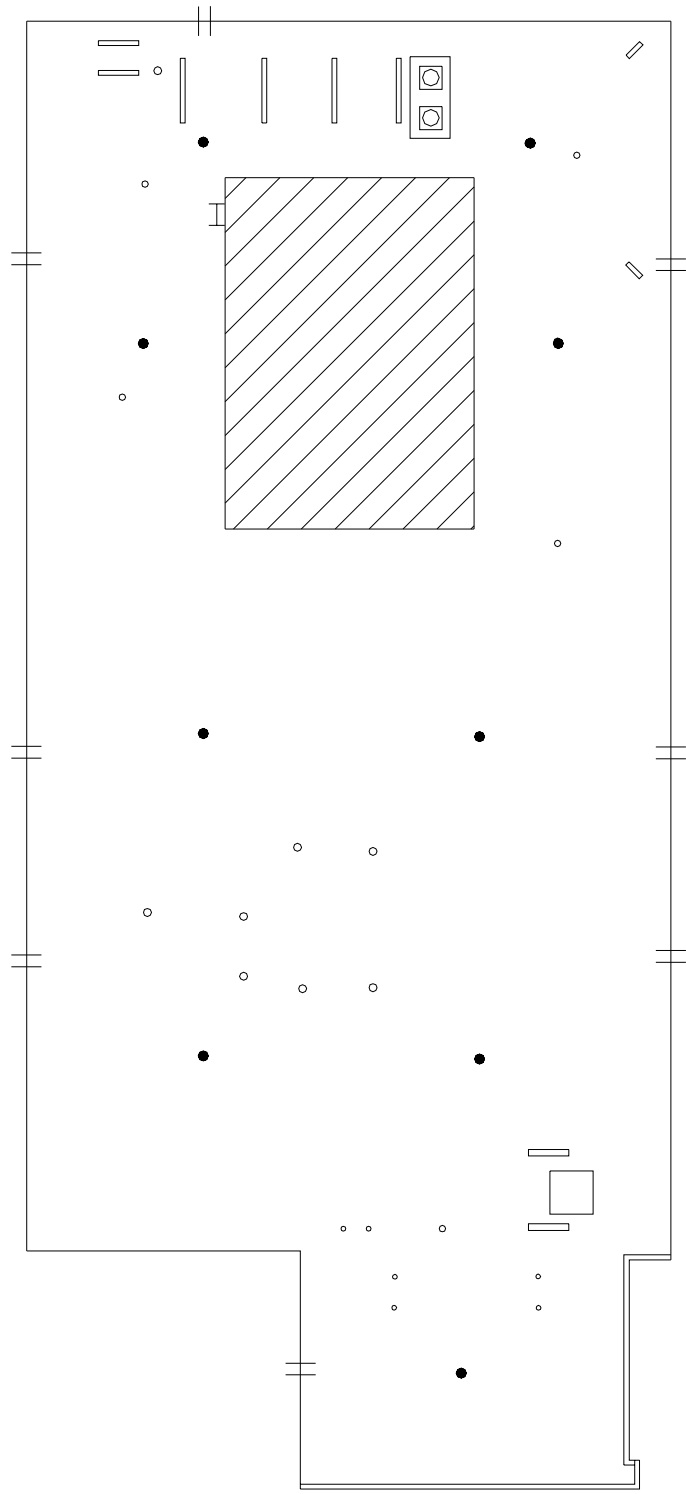

SYMBOLS KEY

- ROOF CURB
- ≡ SLEEPER CURB
- ROOF DRAIN
- VENT STACK
- ⊕ SCUPPER
- ⊖ DEFECT-NO REPAIR

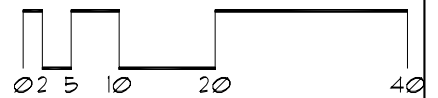
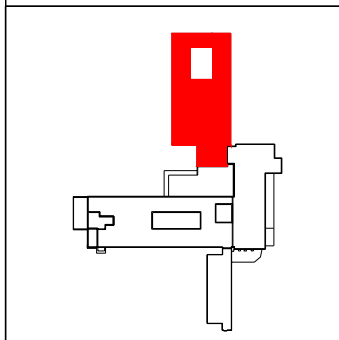

Roof Corrective Action

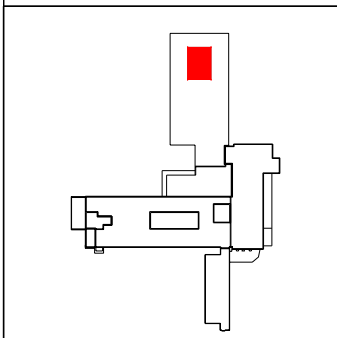
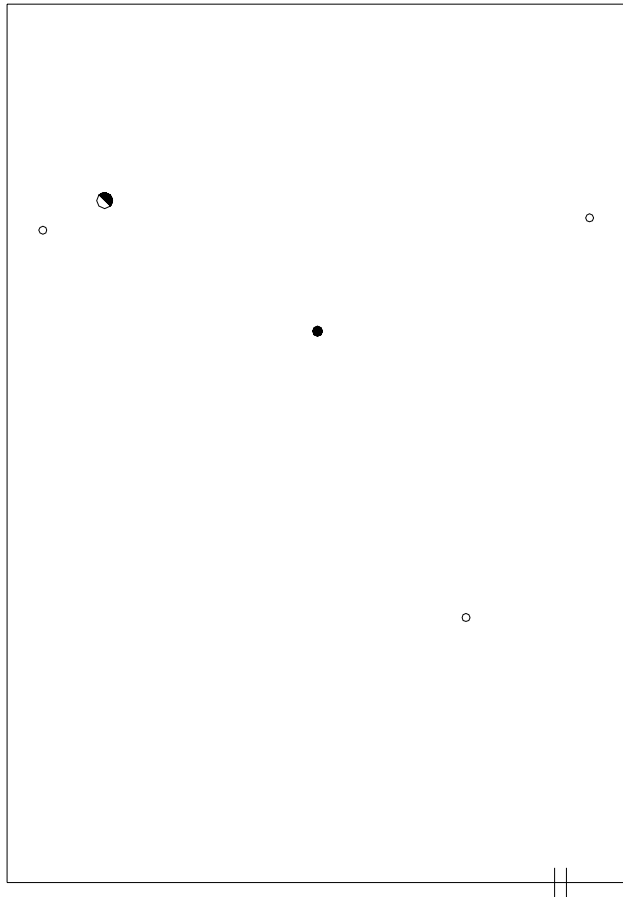

SYMBOLS KEY

- ROOF DRAIN
- VENT STACK
- ◐ HEAT STACK
- ≡ SCUPPER

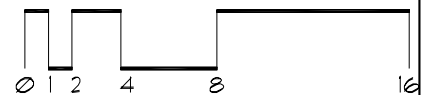
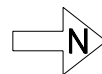

Roof Corrective Action

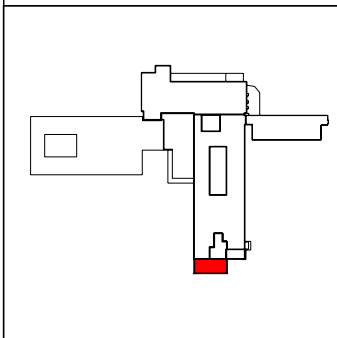
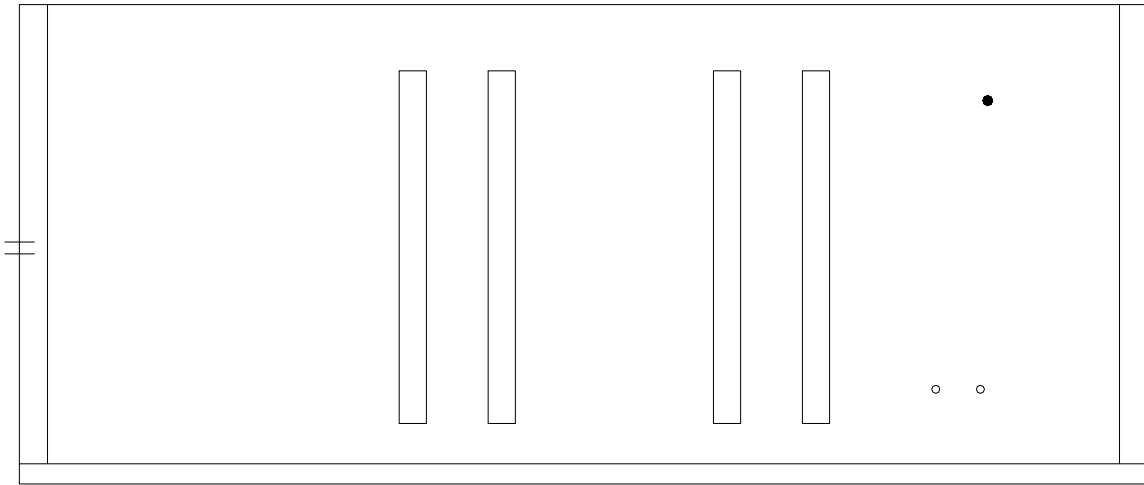

SYMBOLS KEY

- ROOF CURB
- ROOF DRAIN
- VENT STACK
- ≡ SCUPPER

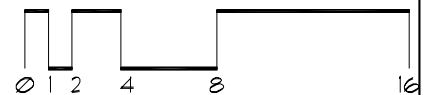

Roof Corrective Action

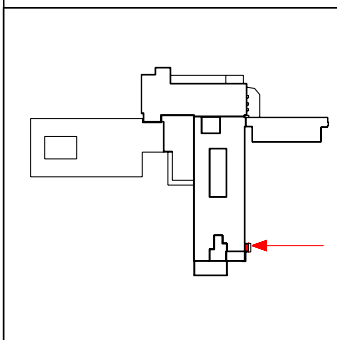
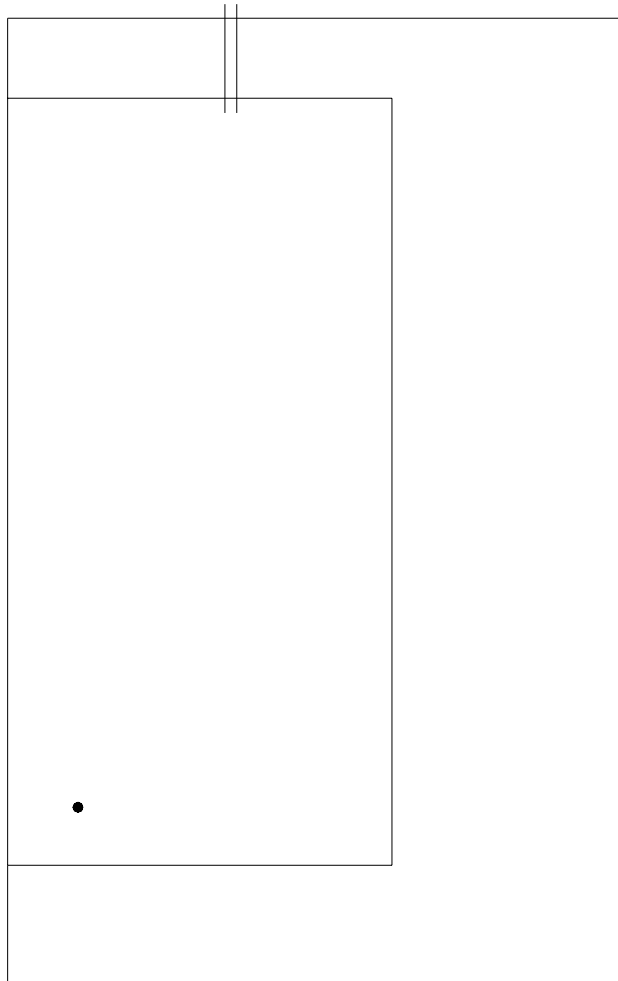

SYMBOLS KEY
● ROOF DRAIN
|| SCUPPER

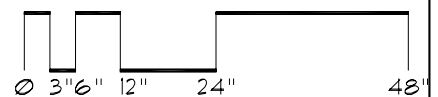

Roof Corrective Action

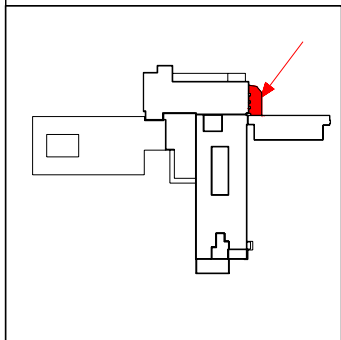
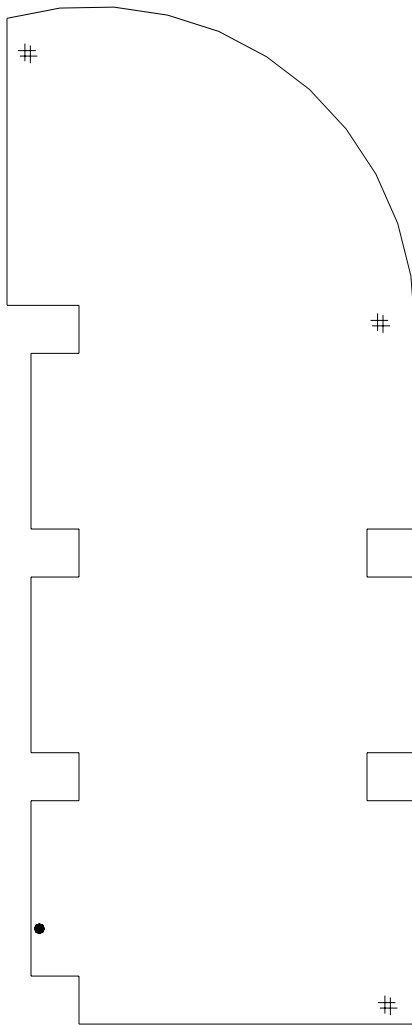

SYMBOLS KEY
• ROOF DRAIN
PITCH PAN

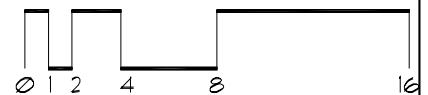

Roof Corrective Action

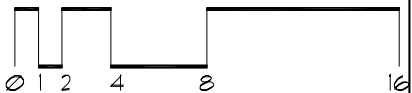
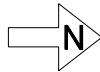
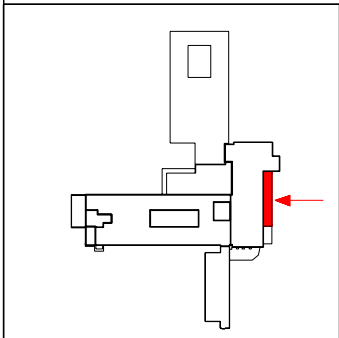

Roof Corrective Action

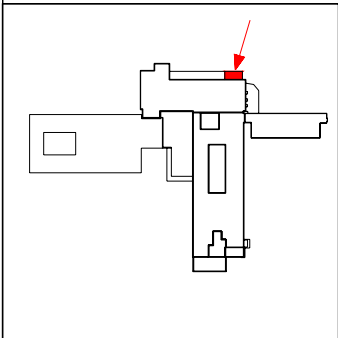

SYMBOLS KEY

- † SCUPPER
- ① DEFECT-NO REPAIR

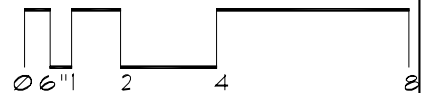

Roof ID

Building: HS074 - Mayo Building - (420 Delaware Street SE Minneapolis, MN)

Roof Access: 4th floor elevator to stairwell out penthouse door (E key)

Total Area: 133,514 sf

A	189 sf	BB	879 sf	D	2,530 sf	EE	922 sf	G	1,183 sf	HH	208 sf
AA	735 sf	BBB	42 sf	DD	2,355 sf	F	576 sf	GG	299 sf	HHH	1,870 sf
AAA	42 sf	C	3,090 sf	DDD	522 sf	FF	1,185 sf	GGG	4,424 sf	I	3,738 sf
B	494 sf	CC	1,814 sf	E	738 sf	FFF	4,045 sf	H	1,872 sf	II	512 sf

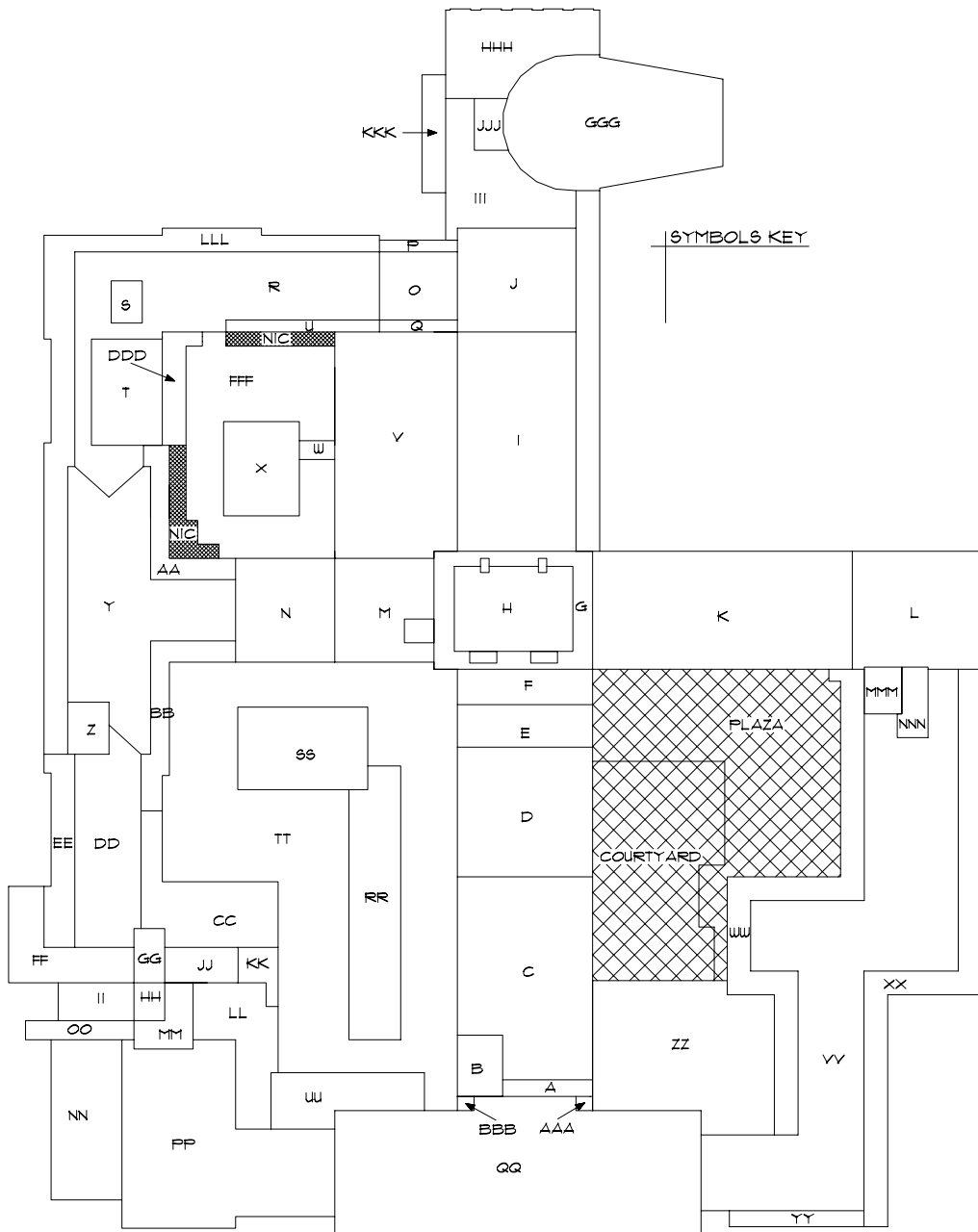

Roof ID

Building: HS074 - Mayo Building - (420 Delaware Street SE Minneapolis, MN)

Roof Access: 4th floor elevator to stairwell out penthouse door (E key)

Total Area: 133,514 sf

III	1,742 sf	K	5,390 sf	LL	1,426 sf	MMM	320 sf	O	1,287 sf	Q	165 sf
J	1,554 sf	KK	303 sf	LLL	3,391 sf	N	3,010 sf	OO	368 sf	QQ	8,473 sf
JJ	465 sf	KKK	500 sf	M	1,681 sf	NN	2,040 sf	P	165 sf	R	5,022 sf
JJJ	275 sf	L	2,750 sf	MM	492 sf	NNN	350 sf	PP	5,294 sf	RR	2,472 sf

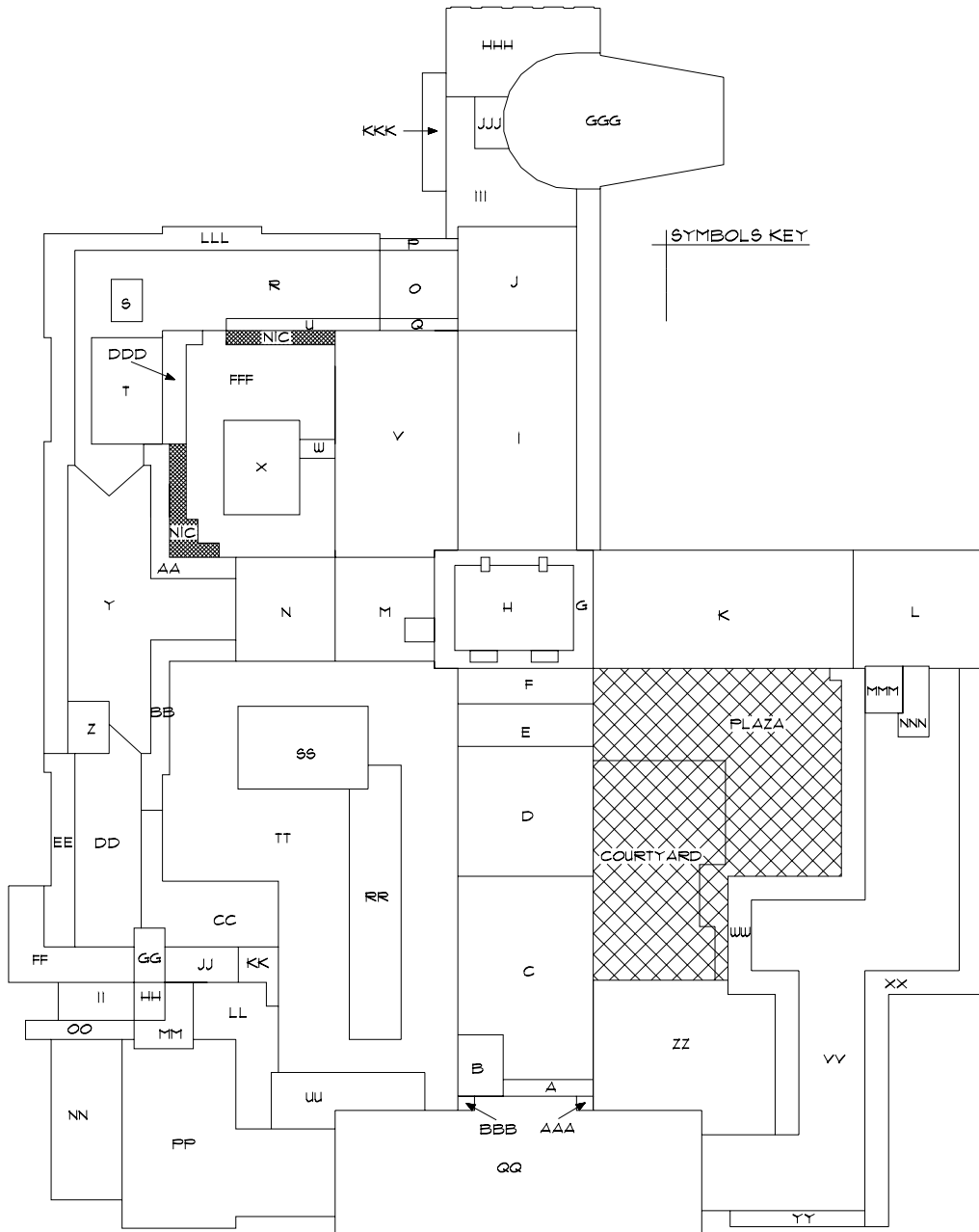

Roof ID

Building: HS074 - Mayo Building - (420 Delaware Street SE Minneapolis, MN)

Roof Access: 4th floor elevator to stairwell out penthouse door (E key)

Total Area: 133,514 sf

S	235 sf	U	325 sf	W	120 sf	Y	4,406 sf
SS	1,925 sf	UU	1,255 sf	WW	2,680 sf	YY	399 sf
T	1,350 sf	V	4,962 sf	X	1,280 sf	Z	385 sf
TT	13,438 sf	VV	10,692 sf	XX	2,763 sf	ZZ	4,100 sf

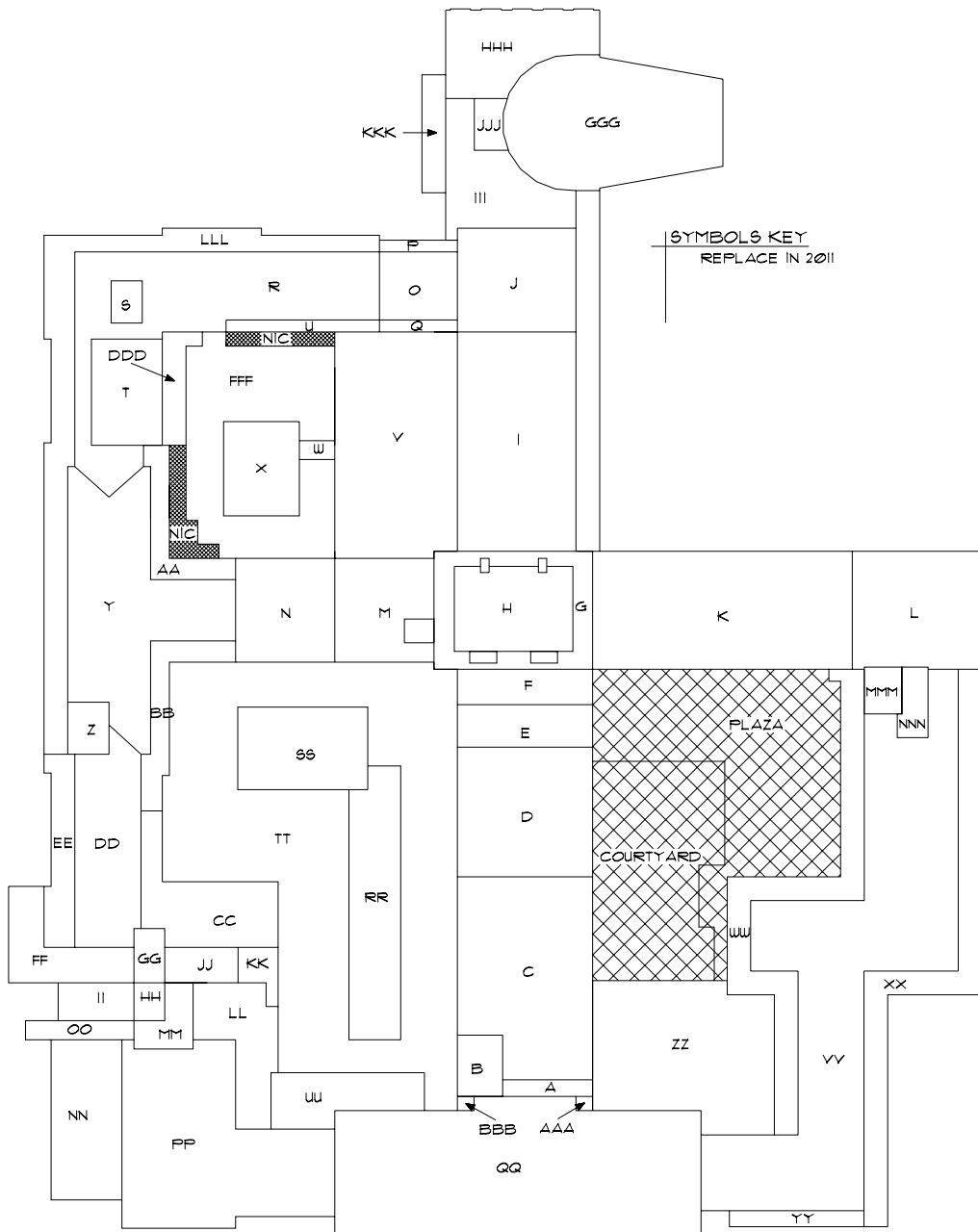

Roof Corrective Action

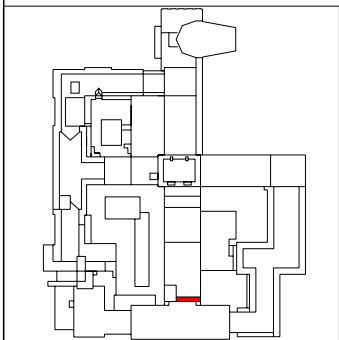
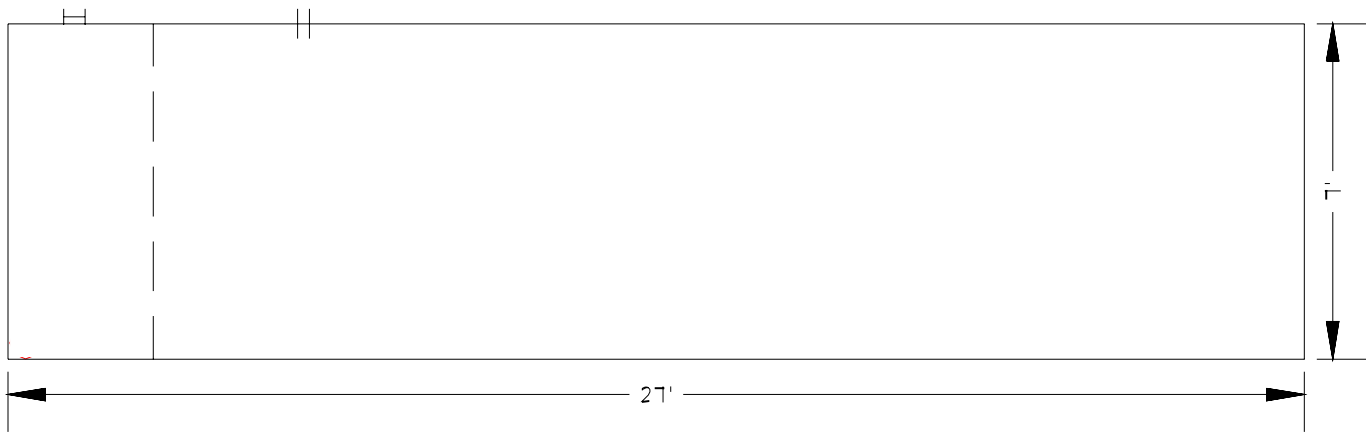

SYMBOLS KEY
□ ROOF CURB
H LADDER

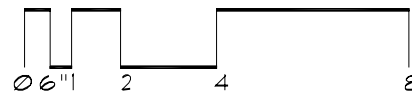

Roof Corrective Action

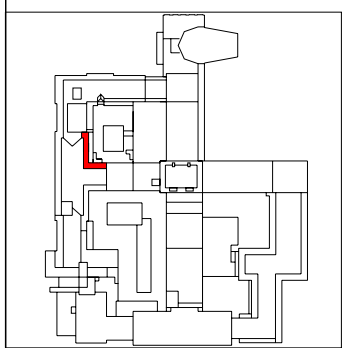
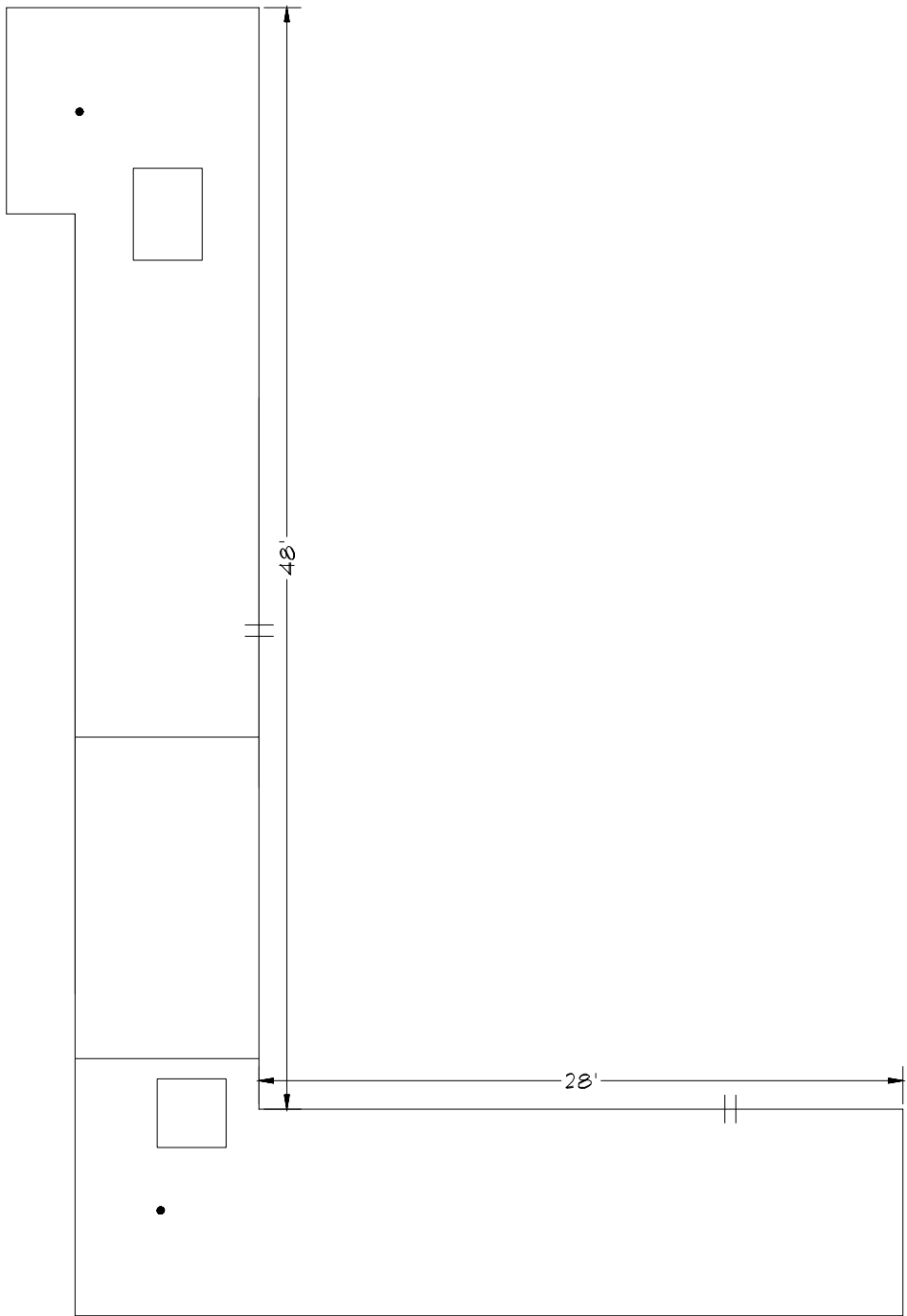

- SYMBOLS KEY**
- ROOF CURB
 - ROOF DRAIN
 - ≡ SCUPPER

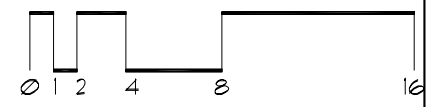
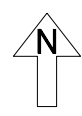

Roof Corrective Action

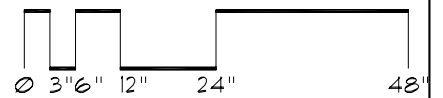
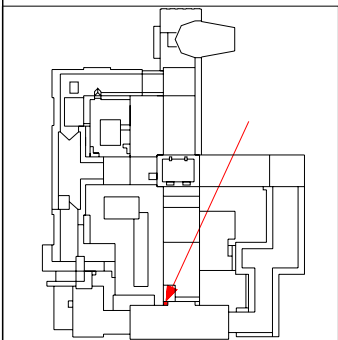
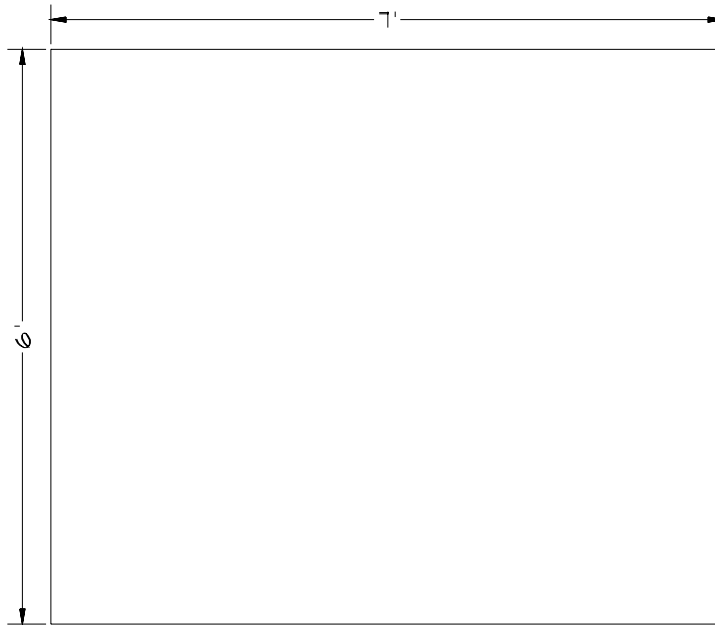

Roof Corrective Action

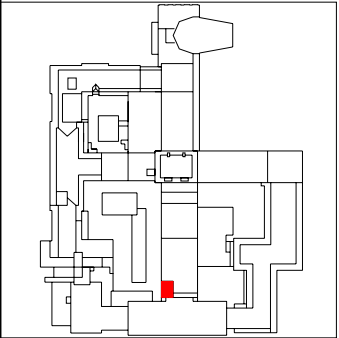
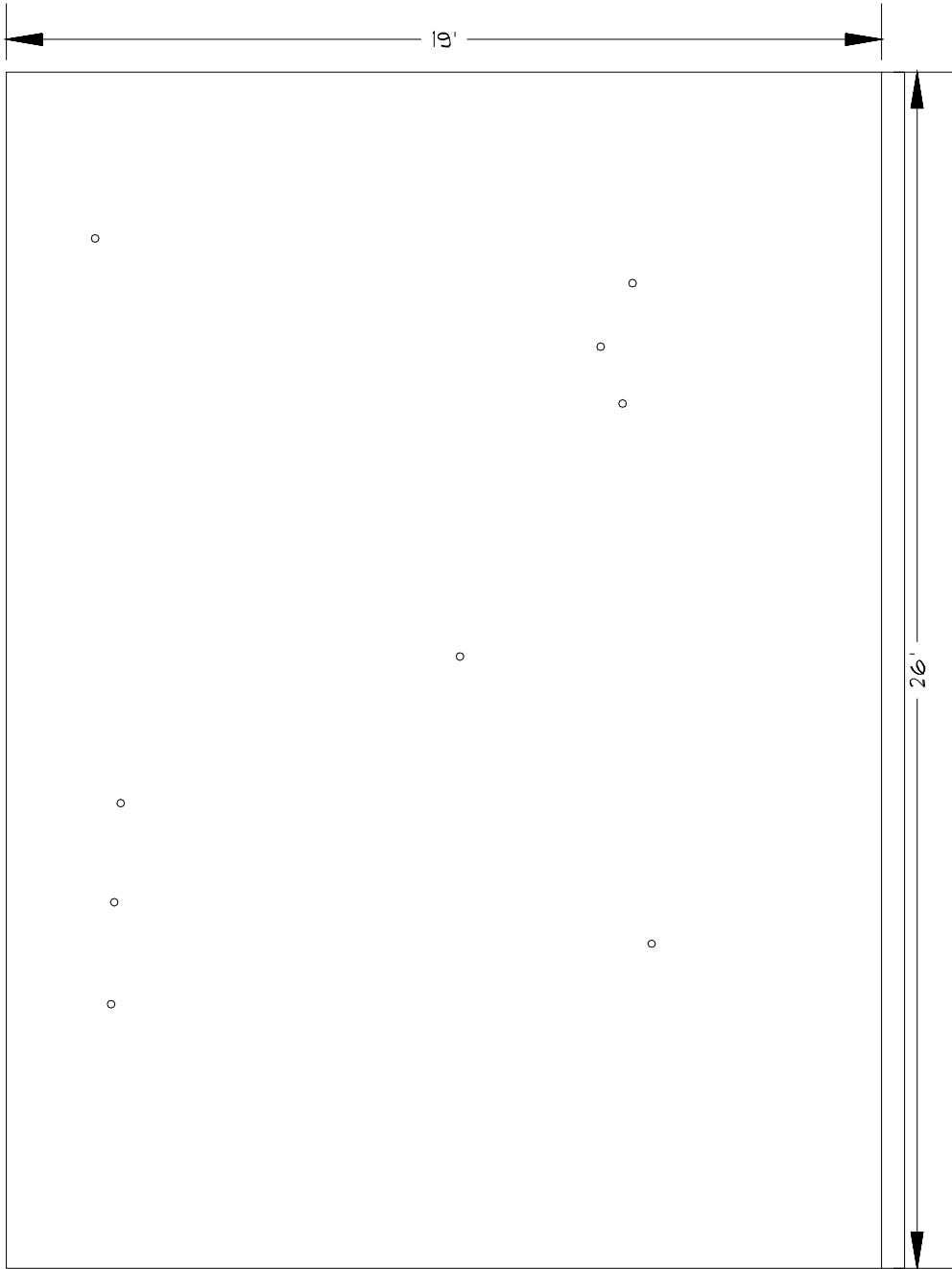

SYMBOLS KEY
○ VENT STACK

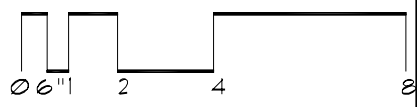

Roof Corrective Action

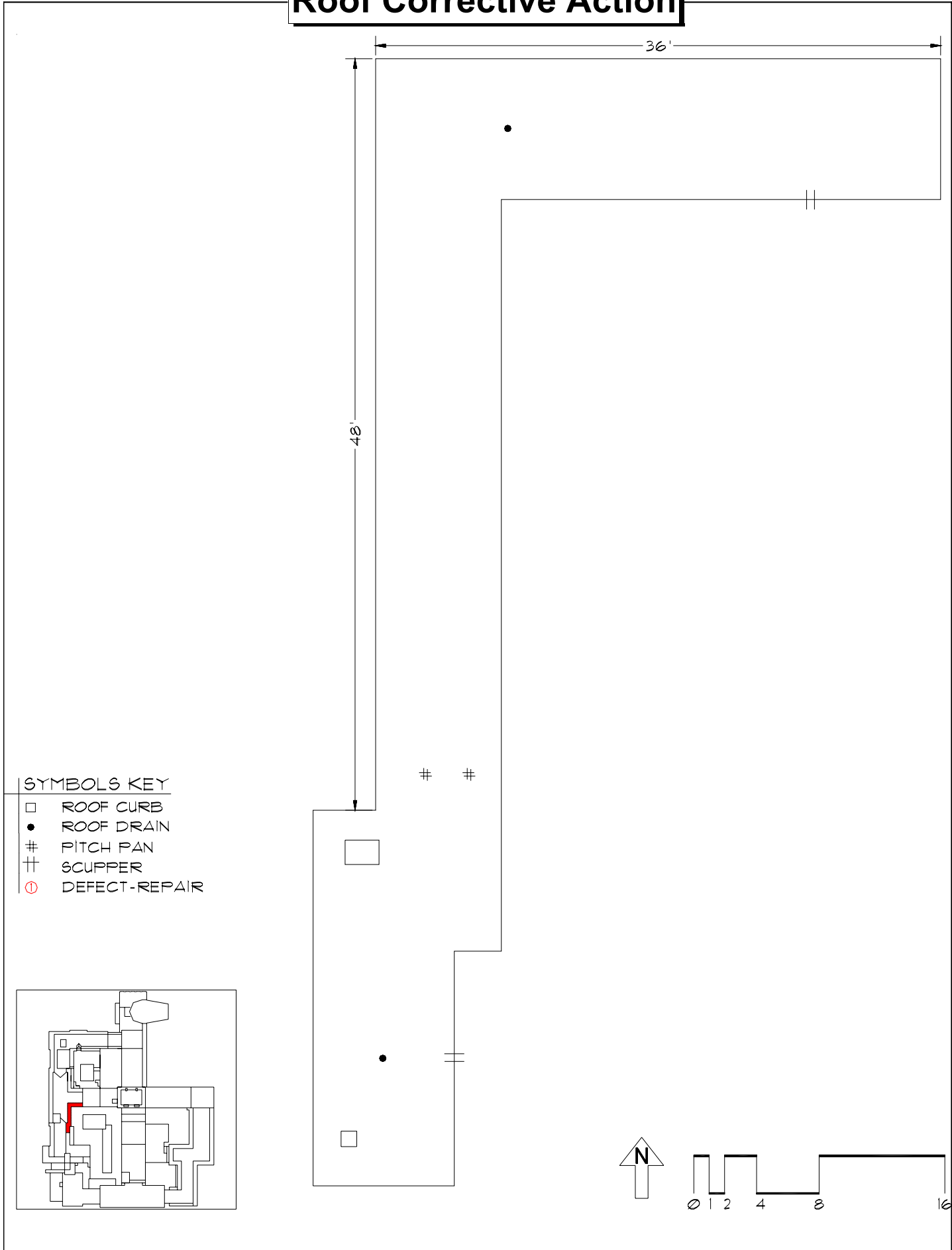

Roof Corrective Action

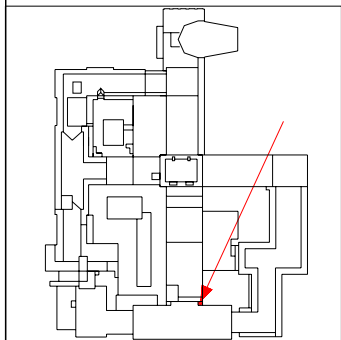
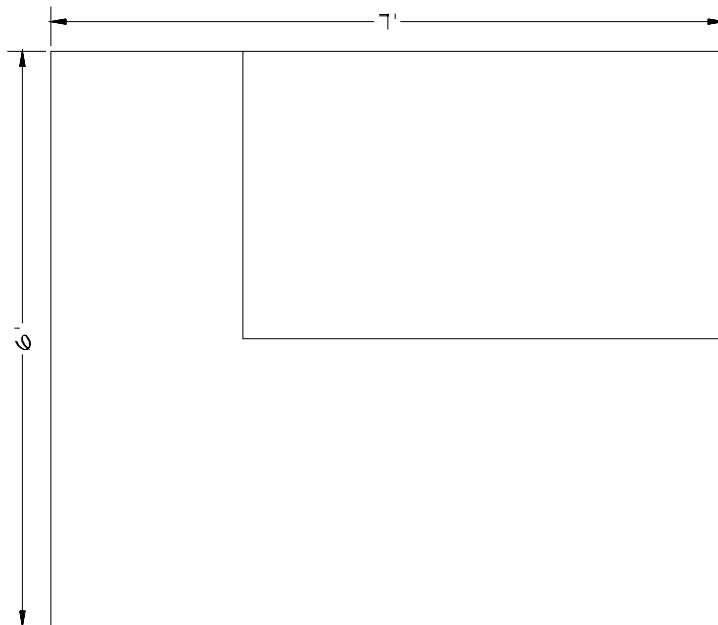

SYMBOLS KEY
□ ROOF CURB

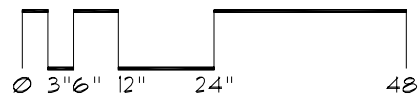

Roof Corrective Action

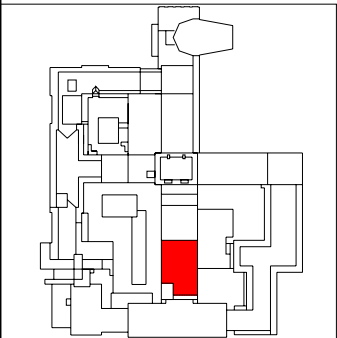
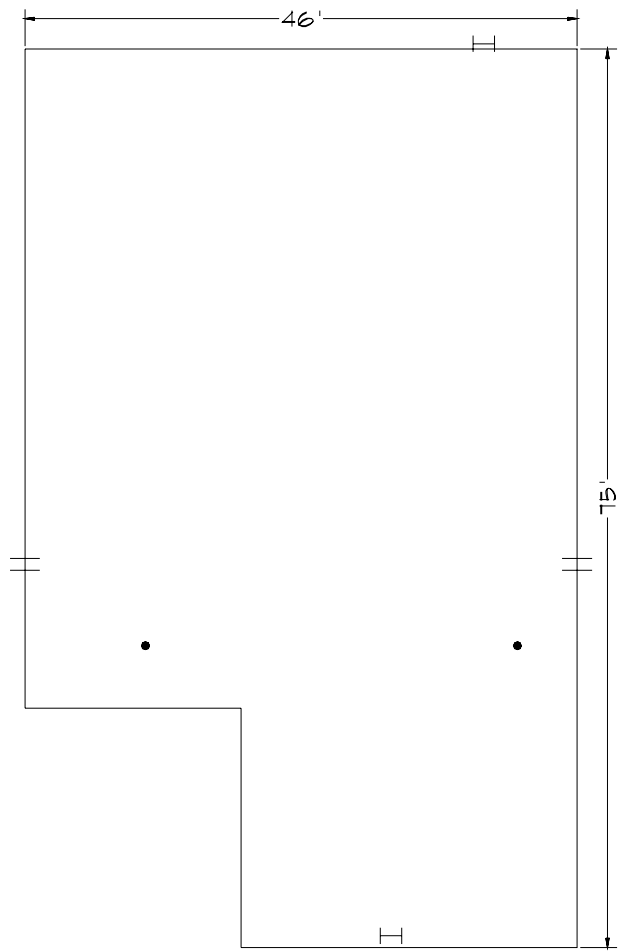

- SYMBOLS KEY**
- ROOF DRAIN
 - VENT STACK
 - ⦶ SCUPPER
 - Ⓢ DEFECT-REPAIR

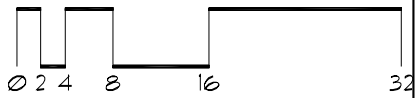

Roof Corrective Action

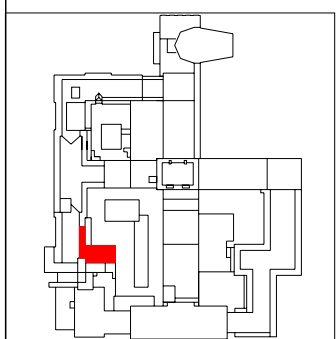
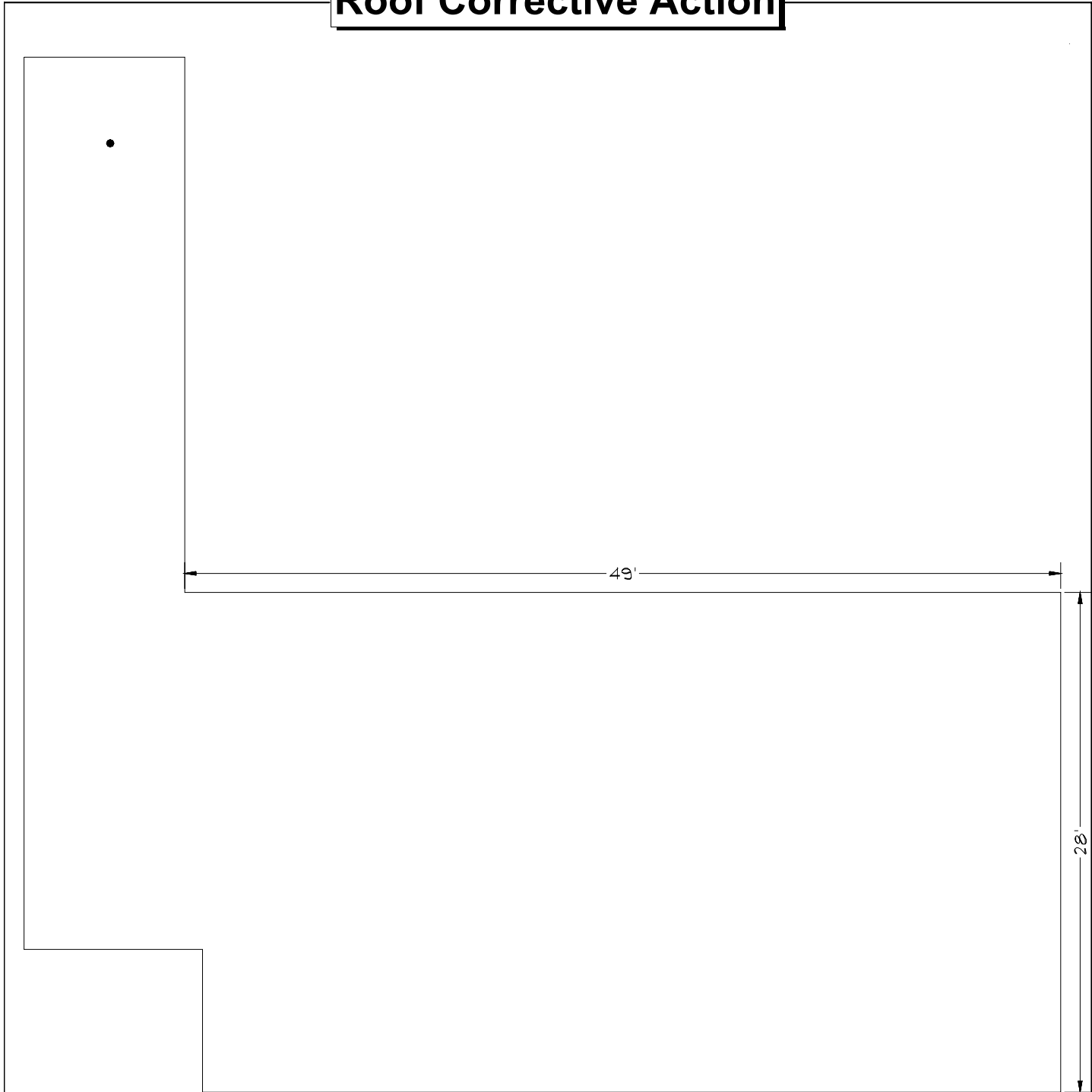

SYMBOLS KEY
① DEFECT-REPAIR

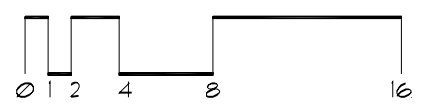

Roof Corrective Action

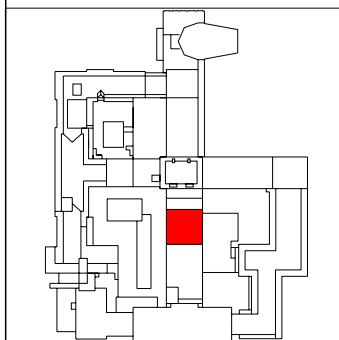
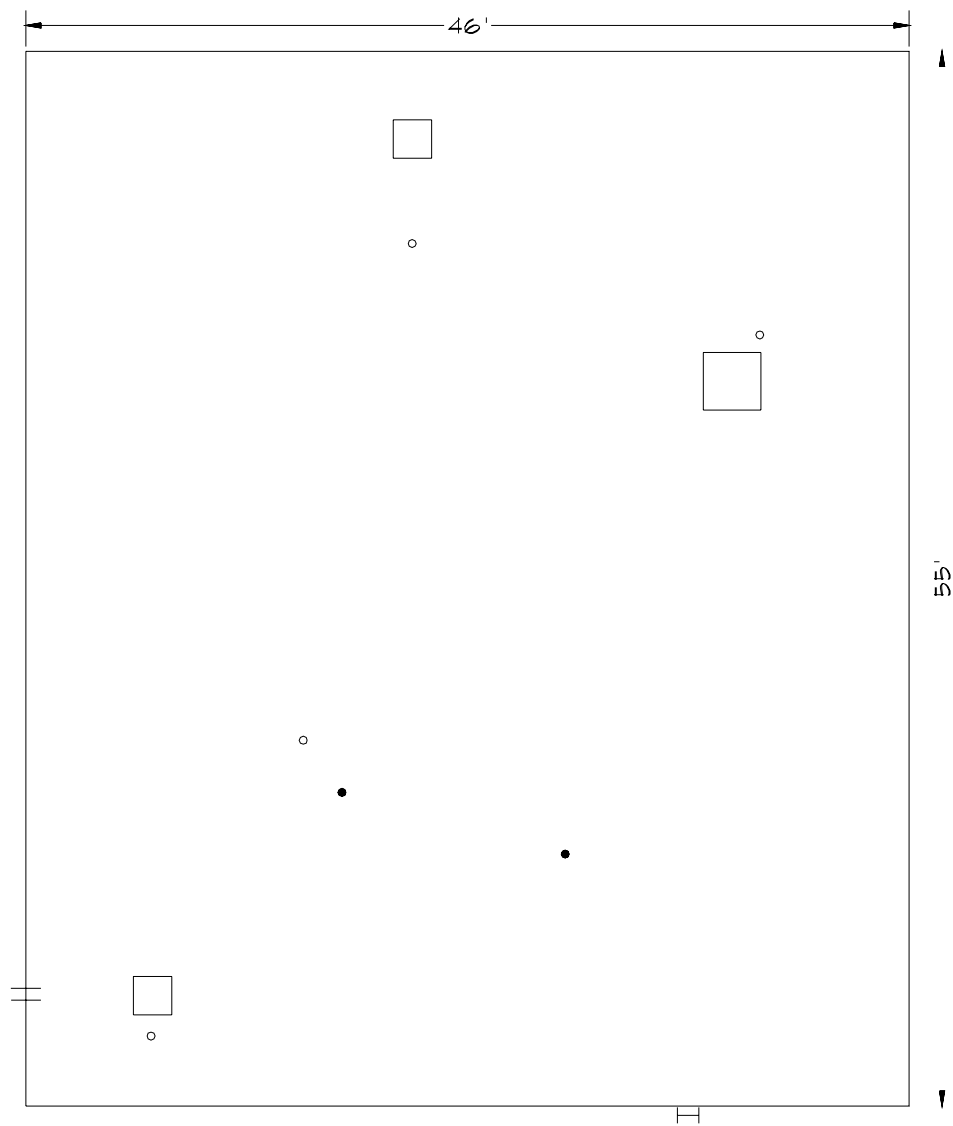

SYMBOLS KEY

- ROOF CURB
- ROOF DRAIN
- VENT STACK
- ⊥ SCUPPER
- ① DEFECT-REPAIR

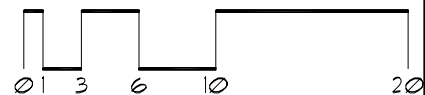

Roof Corrective Action

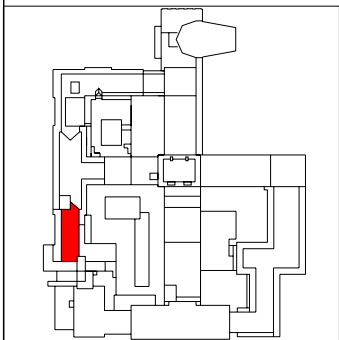
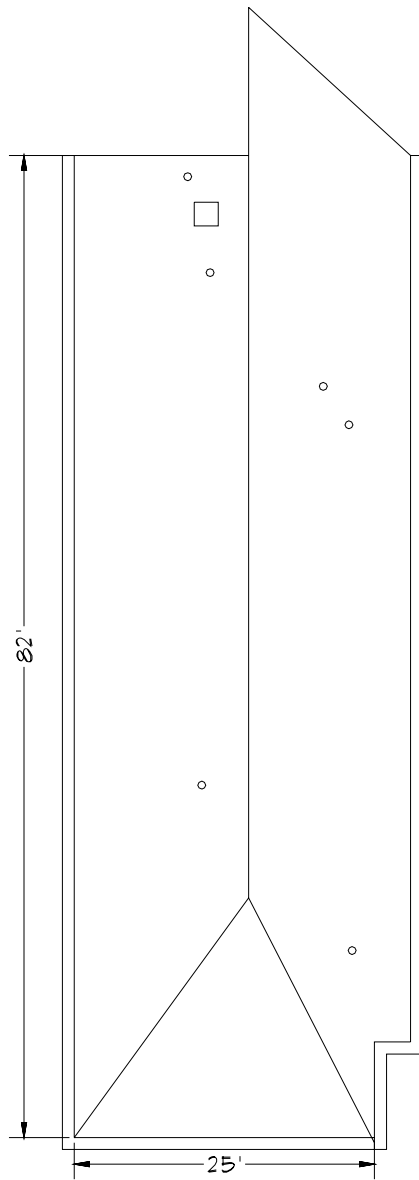

SYMBOLS KEY

- ROOF CURB
- ROOF DRAIN
- VENT STACK

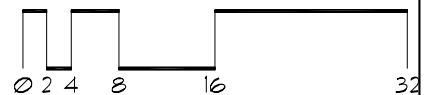

Roof Corrective Action

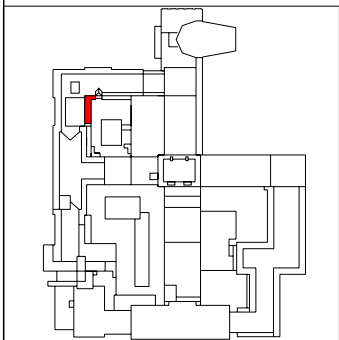
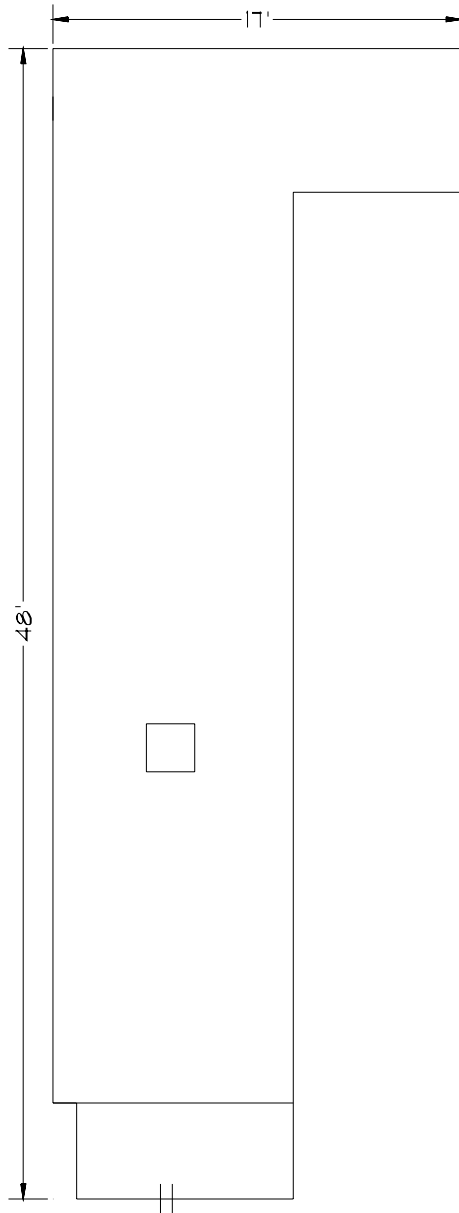

SYMBOLS KEY

- ROOF CURB
- ⊥ SCUPPER
- Ⓢ DEFECT-REPAIR

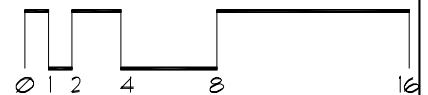

Roof Corrective Action

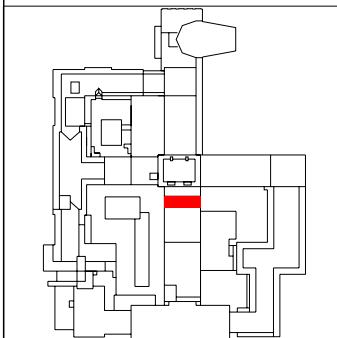
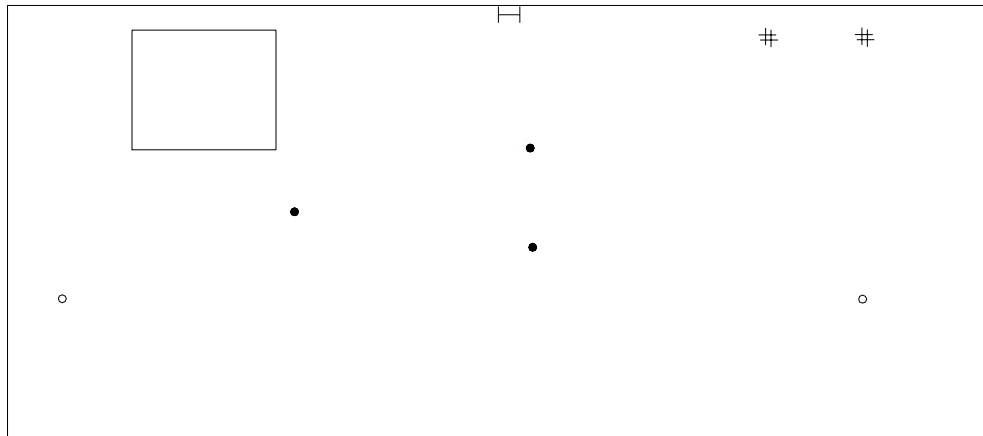

SYMBOLS KEY

- ROOF CURB
- ROOF DRAIN
- VENT STACK
- # PITCH PAN
- I LADDER
- ⊖ DEFECT-NO REPAIR

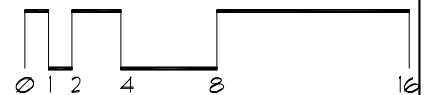

Roof Corrective Action

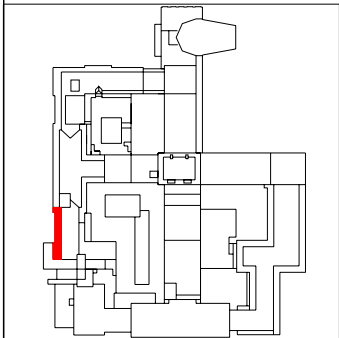
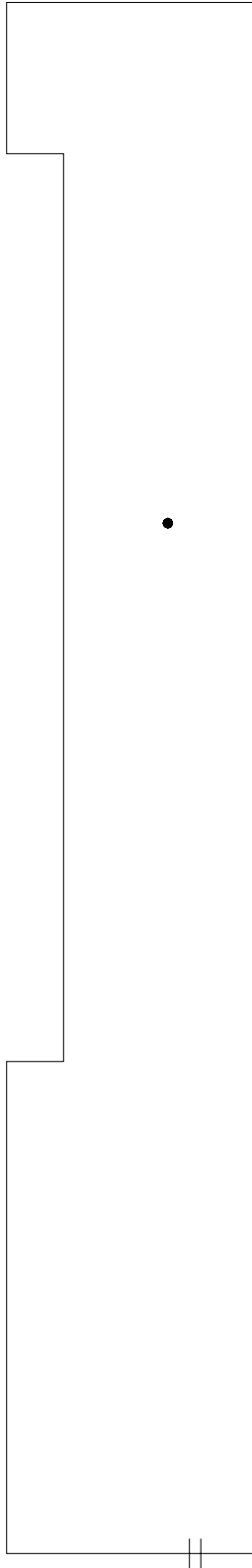

SYMBOLS KEY

- ROOF DRAIN
- ⊥ SCUPPER
- ① DEFECT-REPAIR

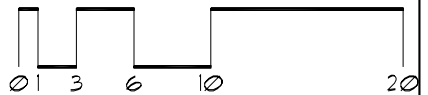

Roof Corrective Action

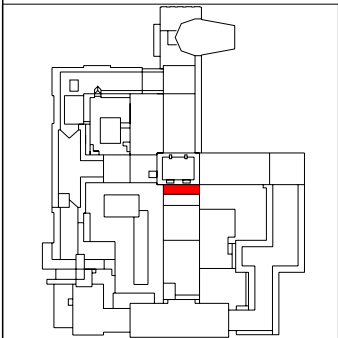
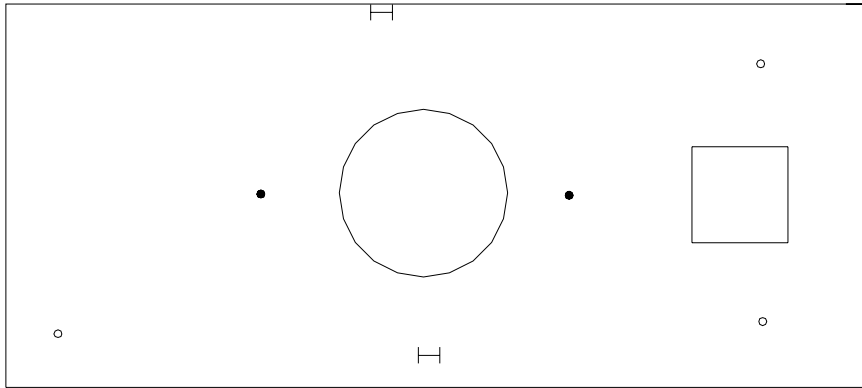

SYMBOLS KEY

- ROOF CURB
- ROOF DRAIN
- VENT STACK
- I LADDER

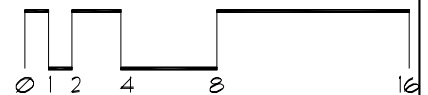

Roof Corrective Action

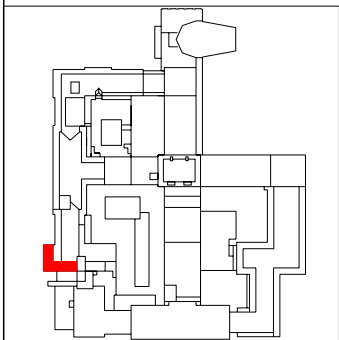
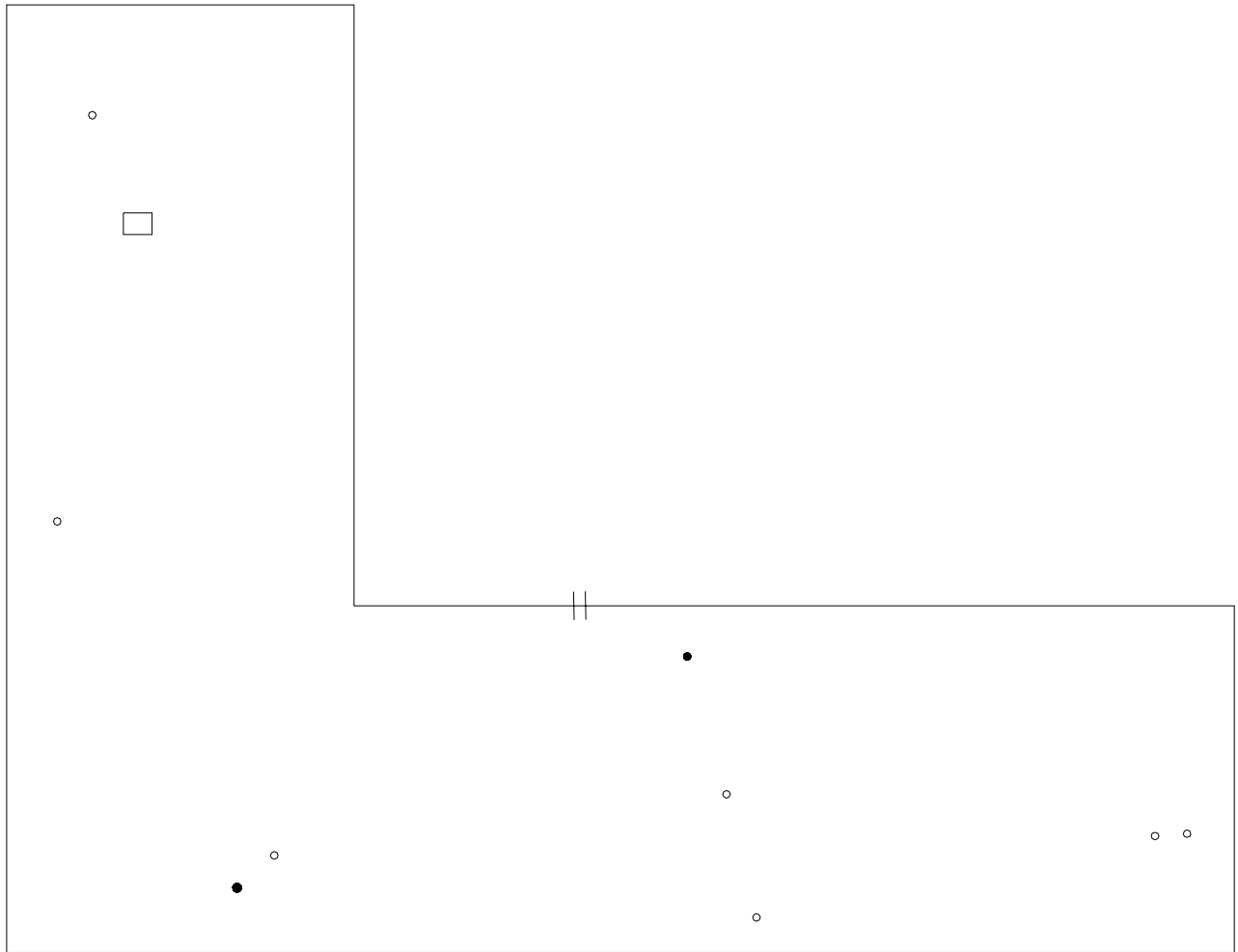

SYMBOLS KEY

- ROOF CURB
- ROOF DRAIN
- VENT STACK
- ≡ SCUPPER
- ⊖ DEFECT-NO REPAIR

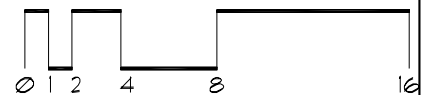

Roof Corrective Action

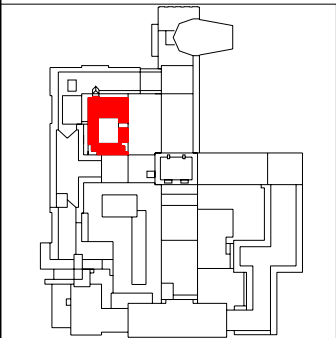
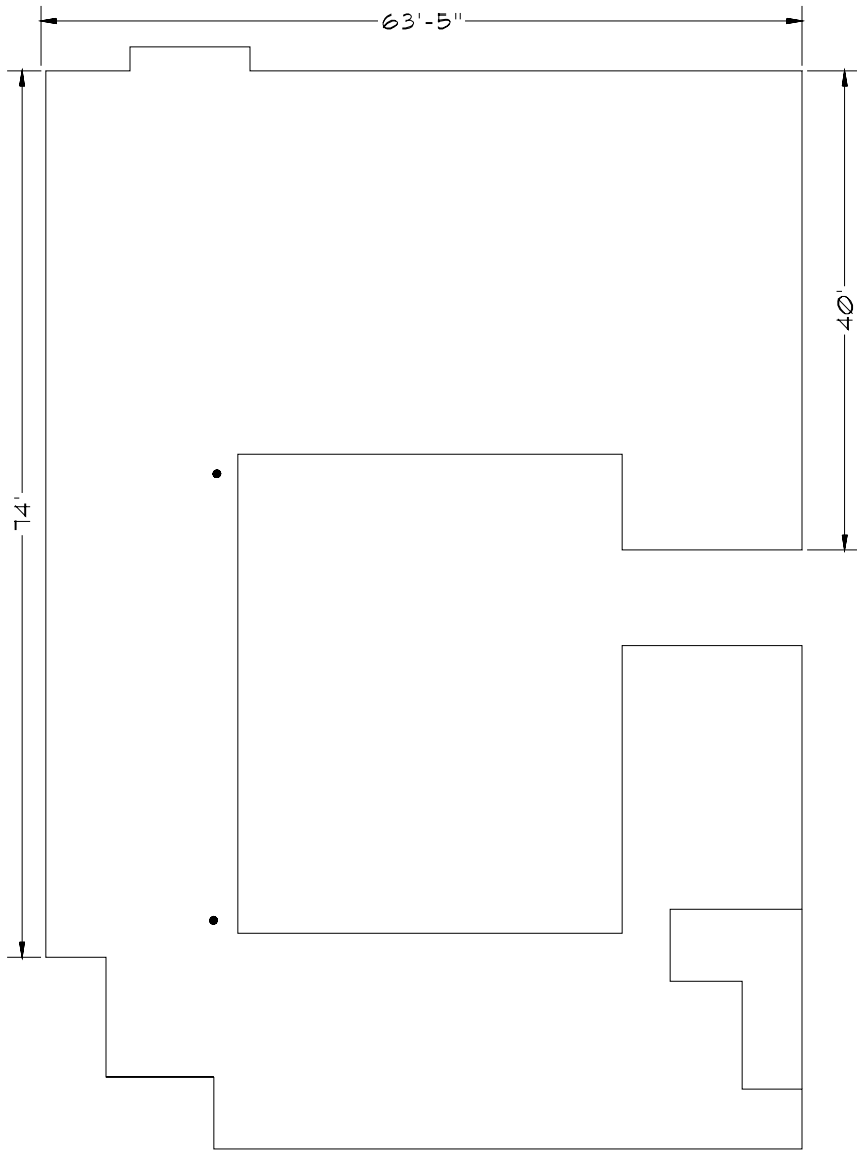

SYMBOLS KEY
● ROOF DRAIN
Ⓢ DEFECT-REPAIR

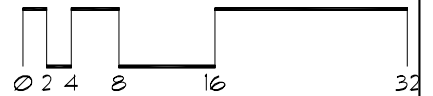

Roof Corrective Action

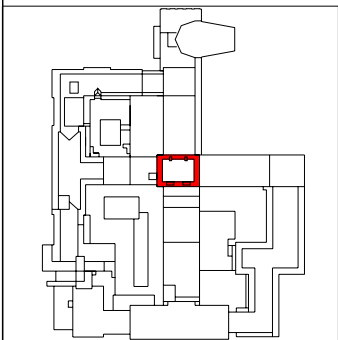
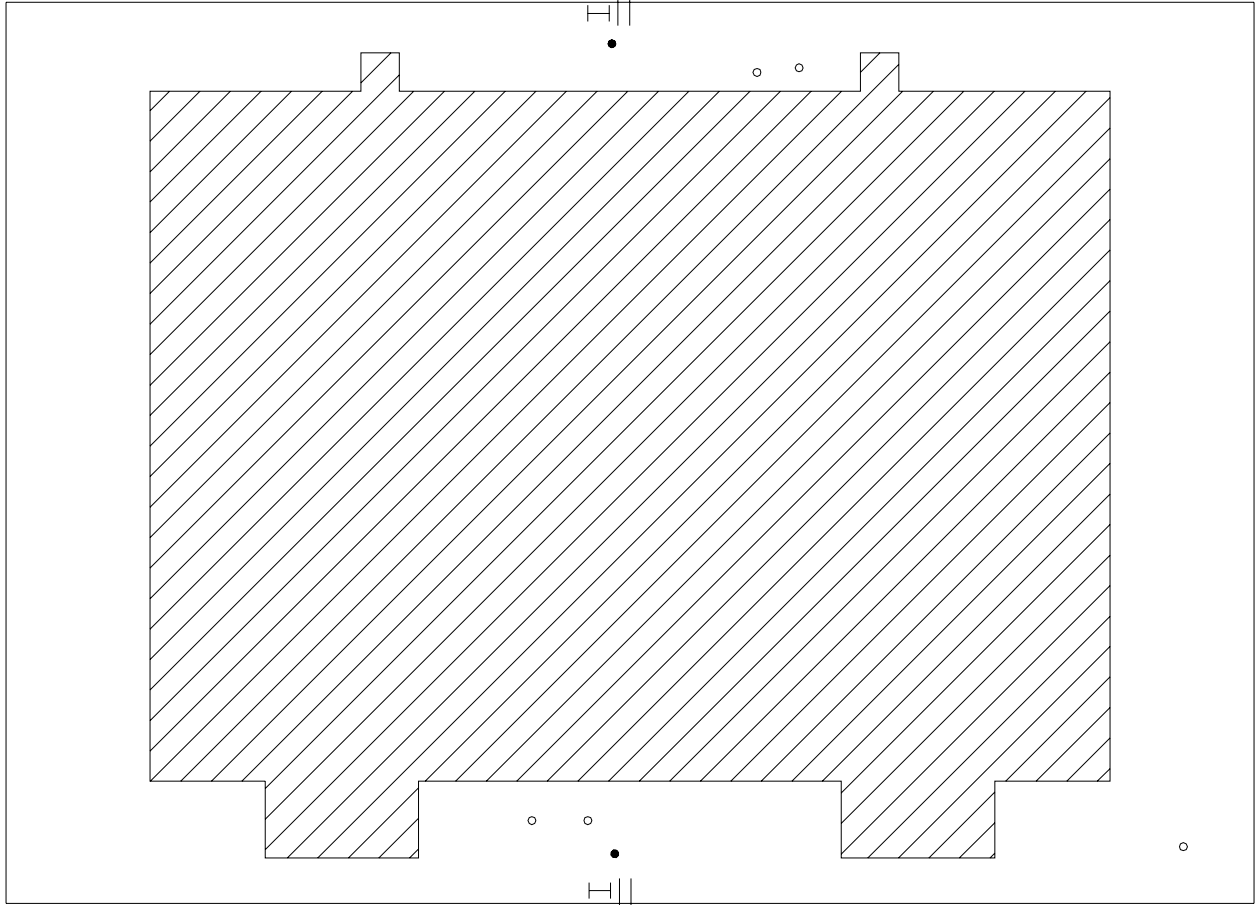

- SYMBOLS KEY**
- ROOF DRAIN
 - VENT STACK
 - ⊥ SCUPPER
 - I LADDER

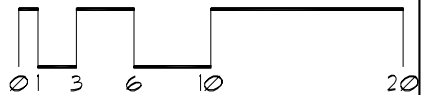

Roof Corrective Action

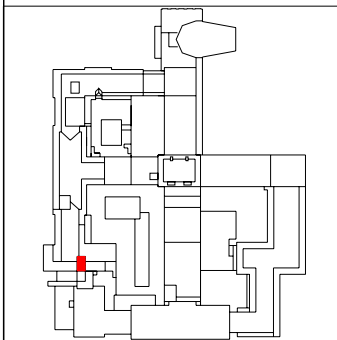
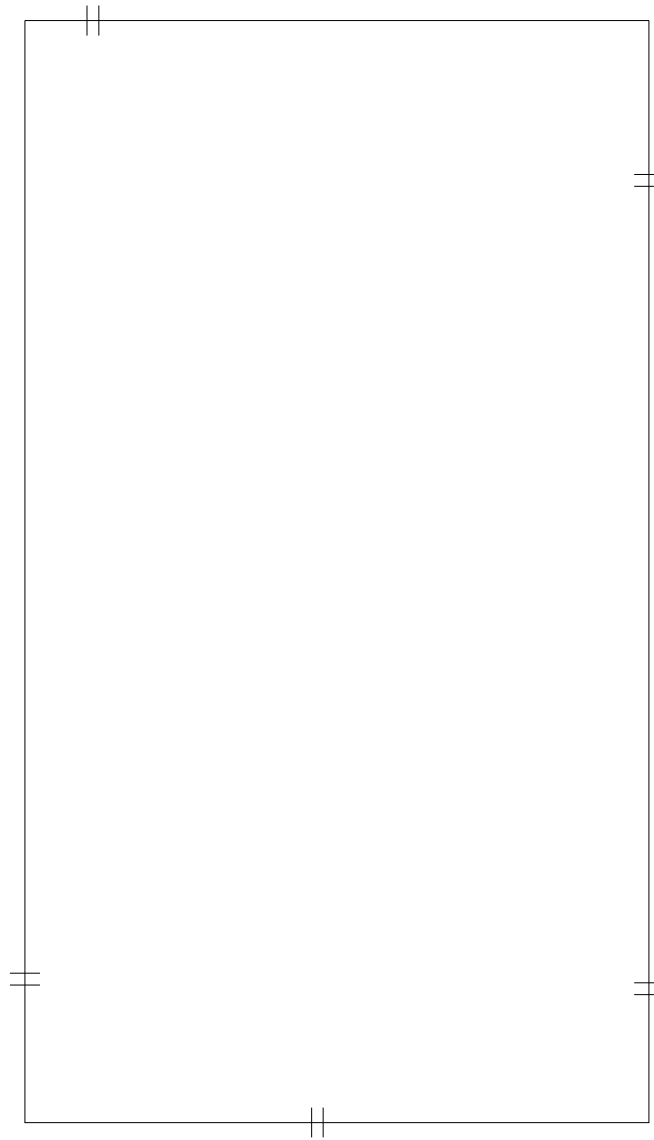

SYMBOLS KEY
|| SCUPPER

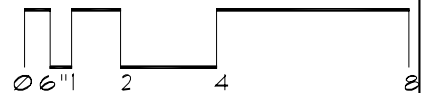

Roof Corrective Action

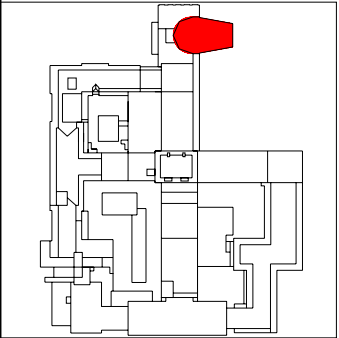
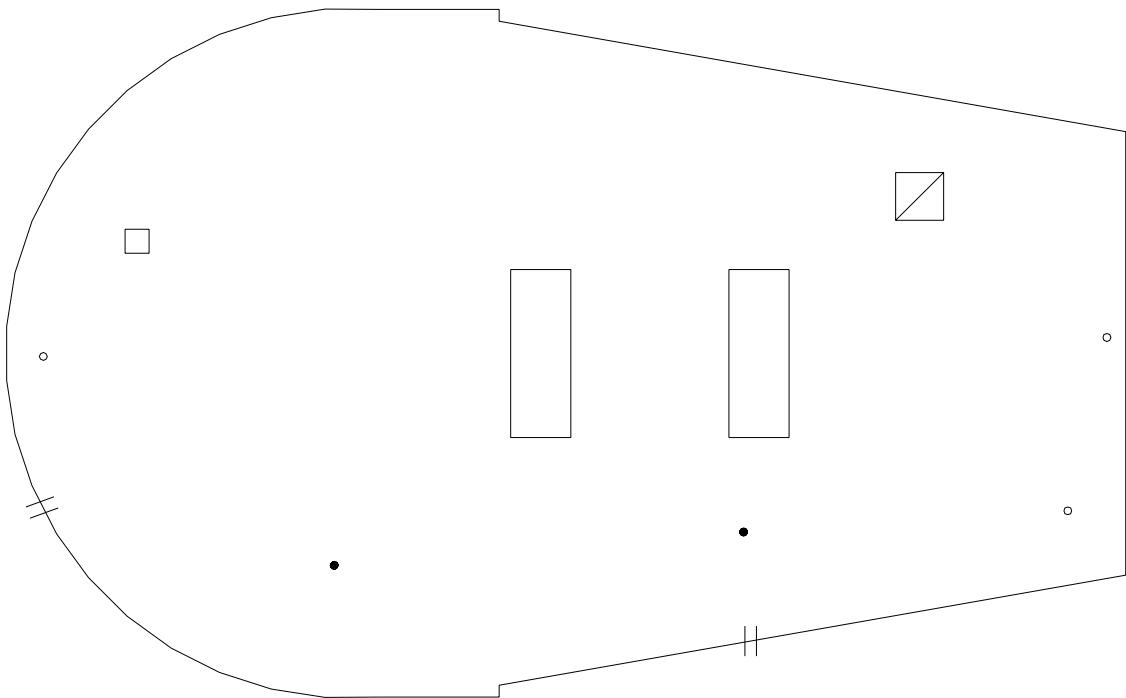

SYMBOLS KEY

- ROOF CURB
- ROOF DRAIN
- VENT STACK
- || SCUPPER
- ▣ ROOF HATCH



Roof Corrective Action

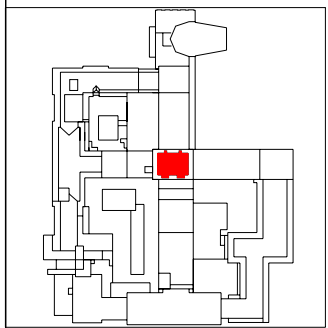
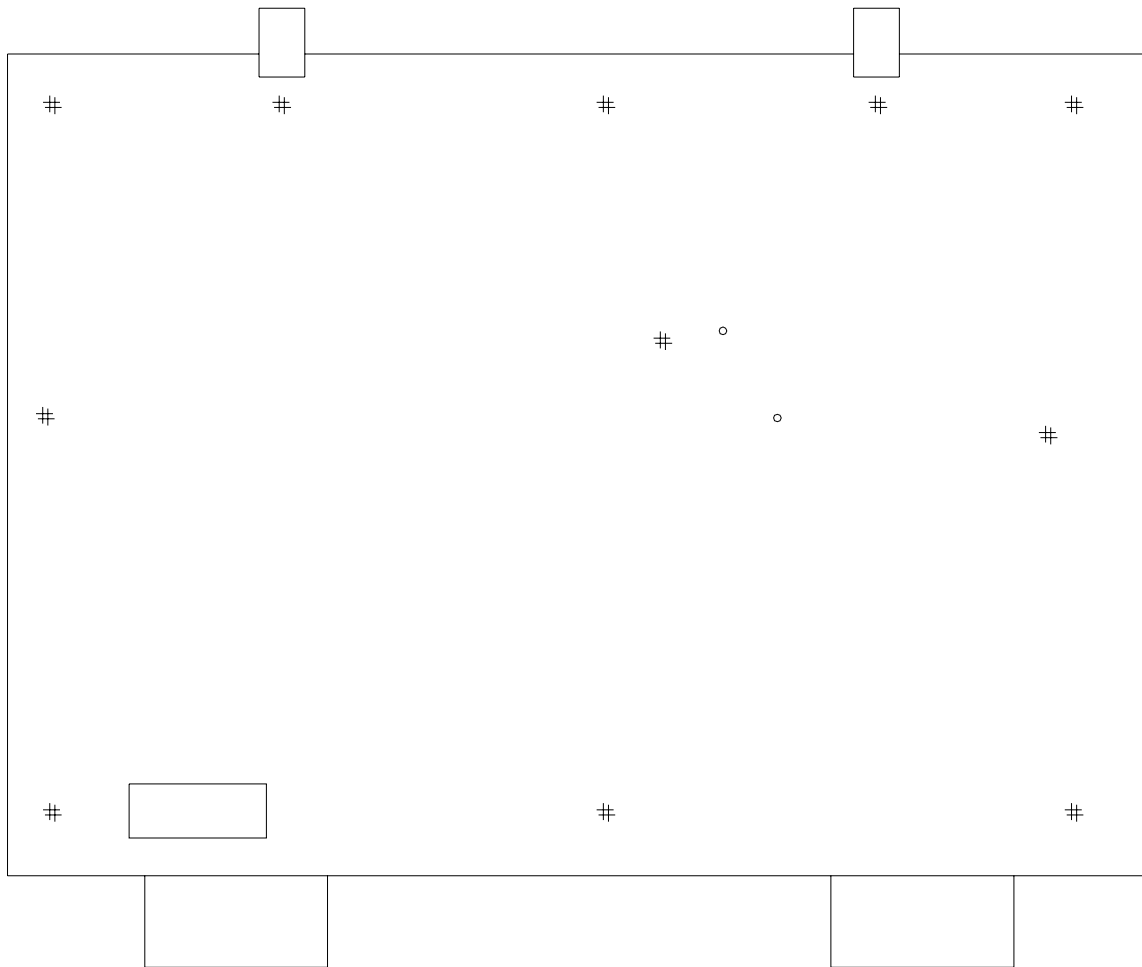

SYMBOLS KEY

- VENT STACK
- # PITCH PAN
- ROOF CURB

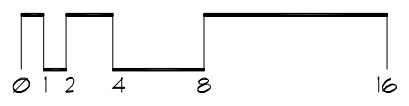

Roof Corrective Action

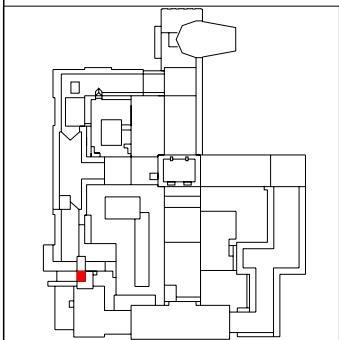
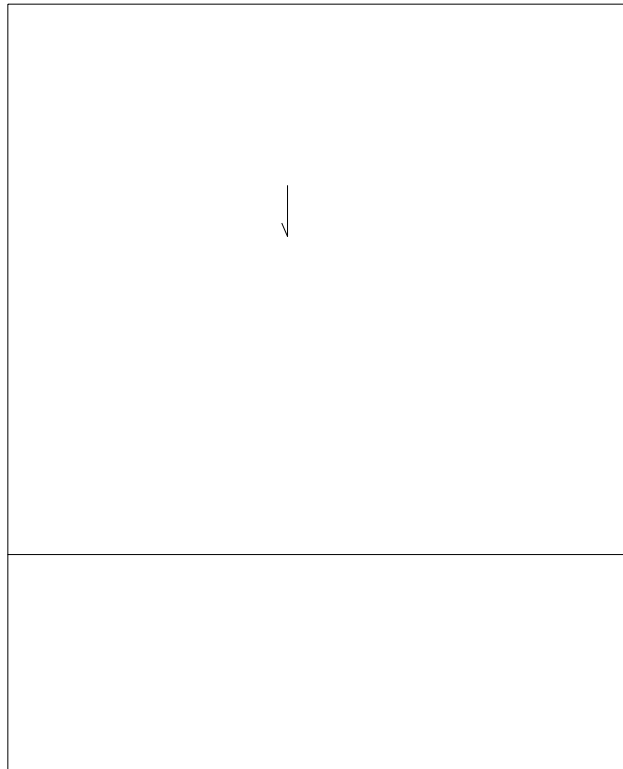

SYMBOLS KEY
→ SLOPE DIRECTION

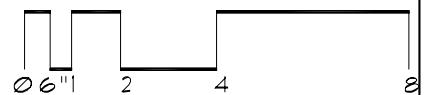

Roof Corrective Action

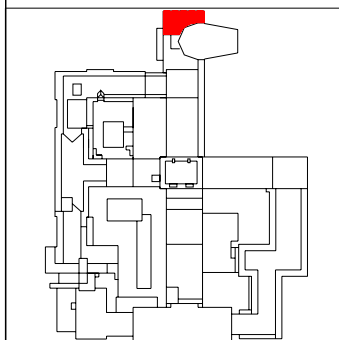
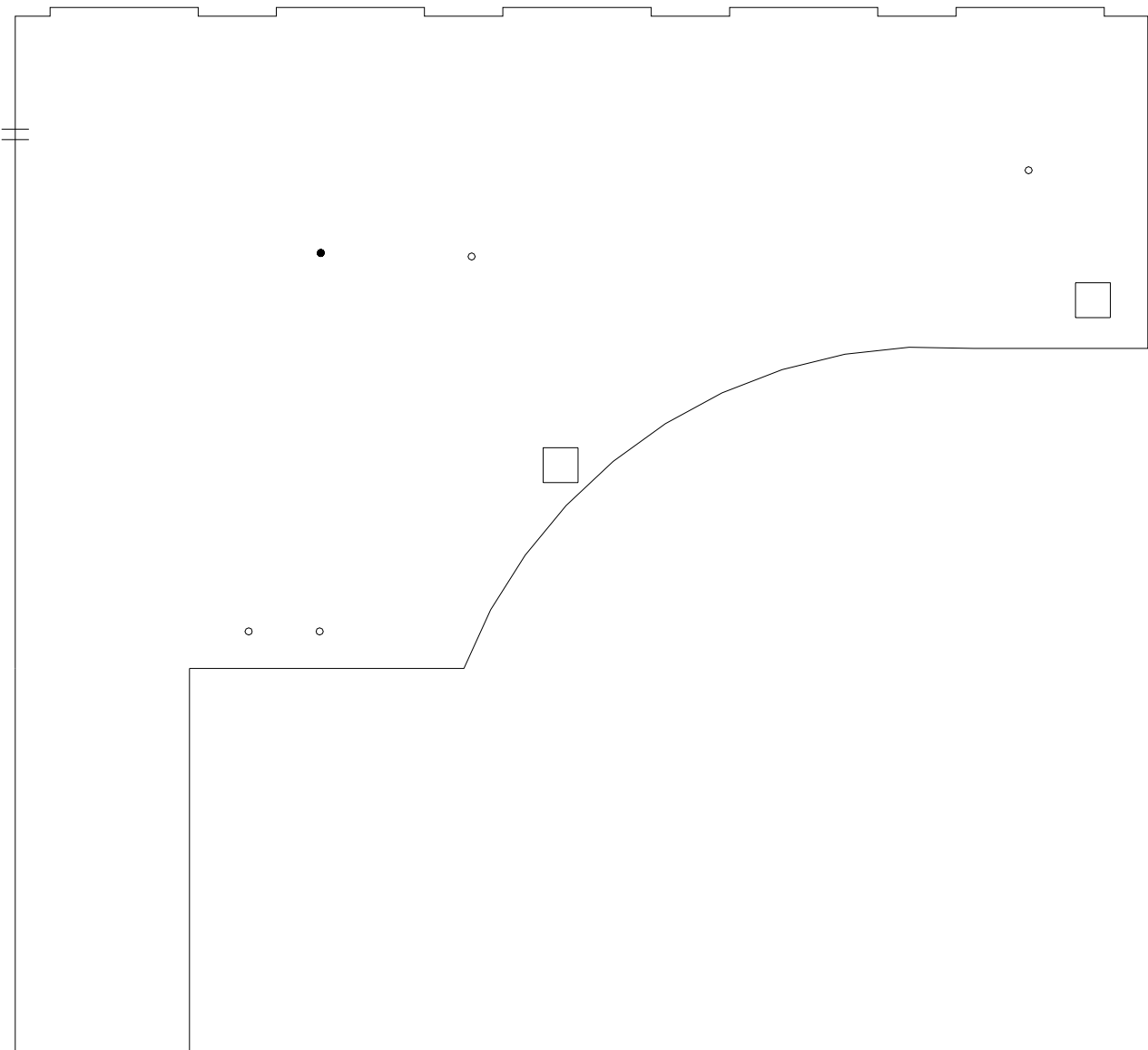

- SYMBOLS KEY**
- ROOF CURB
 - ROOF DRAIN
 - VENT STACK

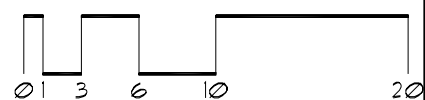

Roof Corrective Action

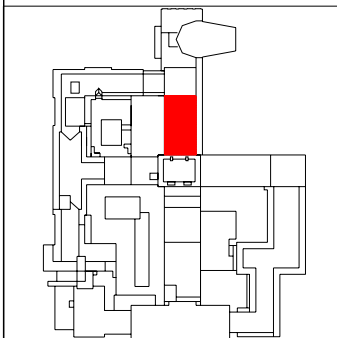
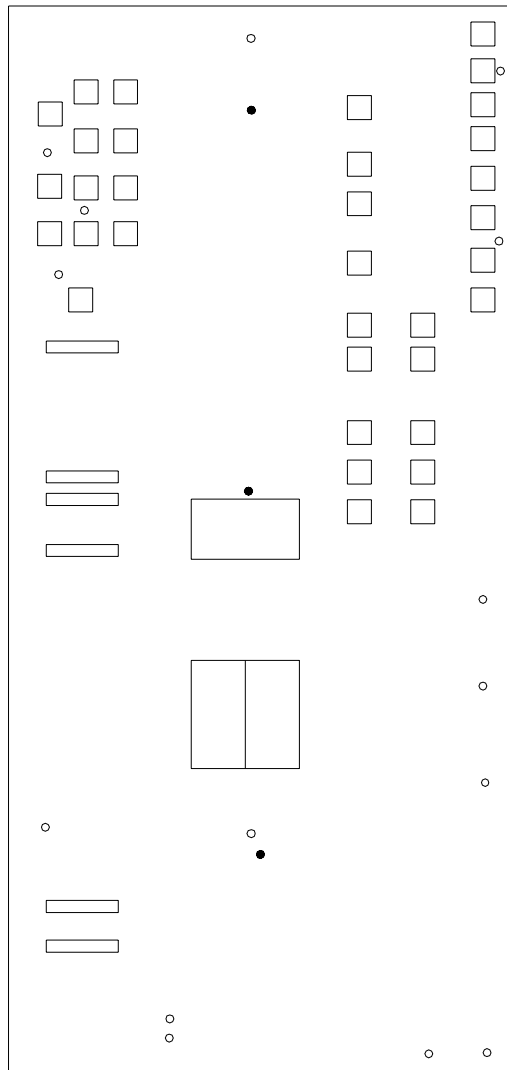

SYMBOLS KEY

- ROOF CURB
- ROOF DRAIN
- VENT STACK
- † SCUPPER
- ⊖ DEFECT-NO REPAIR
- ⊕ DEFECT-REPAIR

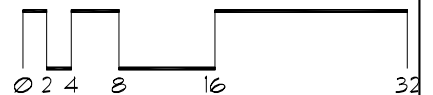

Roof Corrective Action

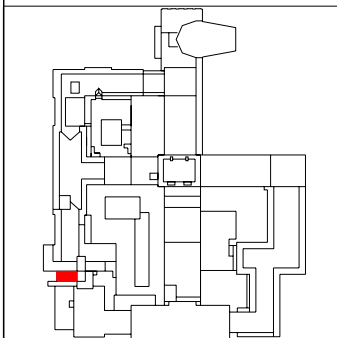
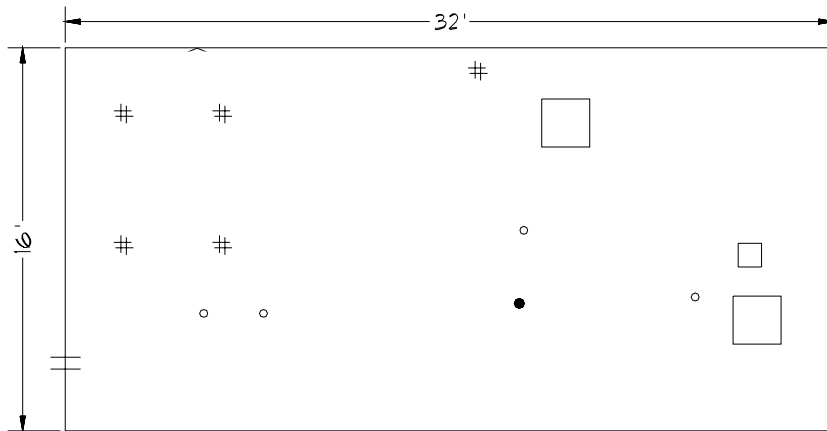

SYMBOLS KEY

- ROOF CURB
- ROOF DRAIN
- VENT STACK
- † SCUPPER
- # PITCH PAN
- Ⓜ DEFECT-REPAIR
- Ⓜ DEFECT-NO REPAIR

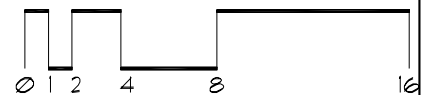

Roof Corrective Action

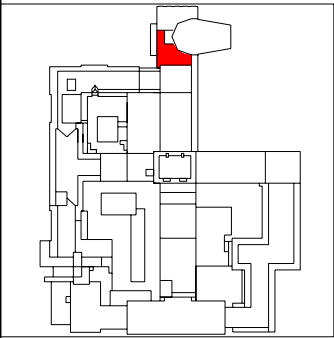
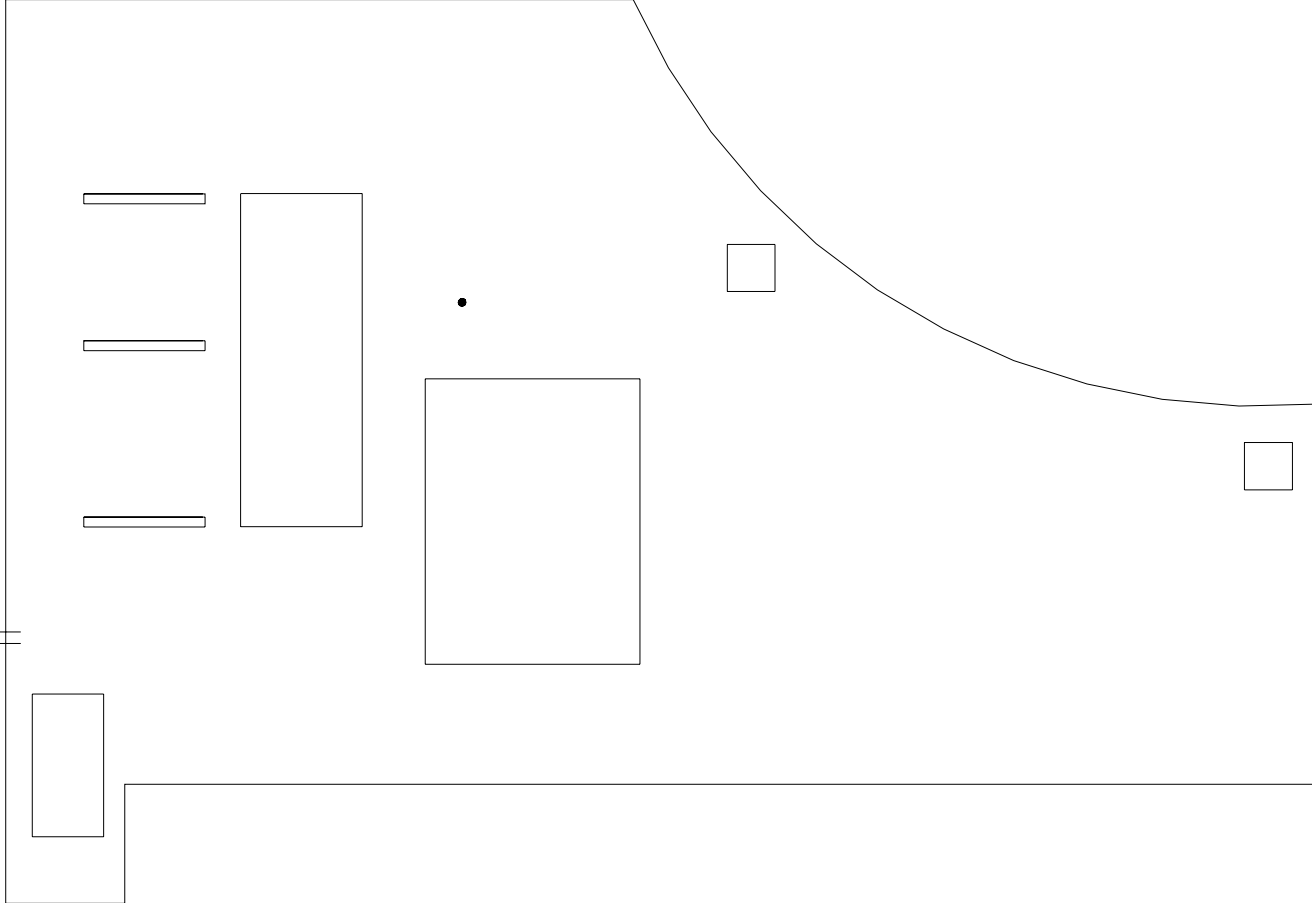

SYMBOLS KEY

- ROOF CURB
- ROOF DRAIN
- ≡ SCUPPER
- ≡ SLEEPER CURB
- Ⓜ DEFECT-REPAIR

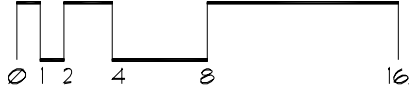

Roof Corrective Action

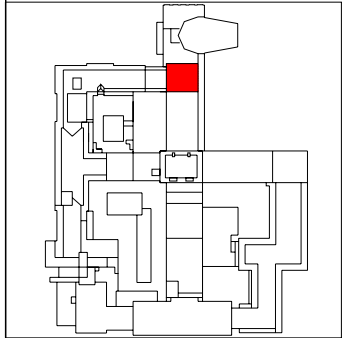
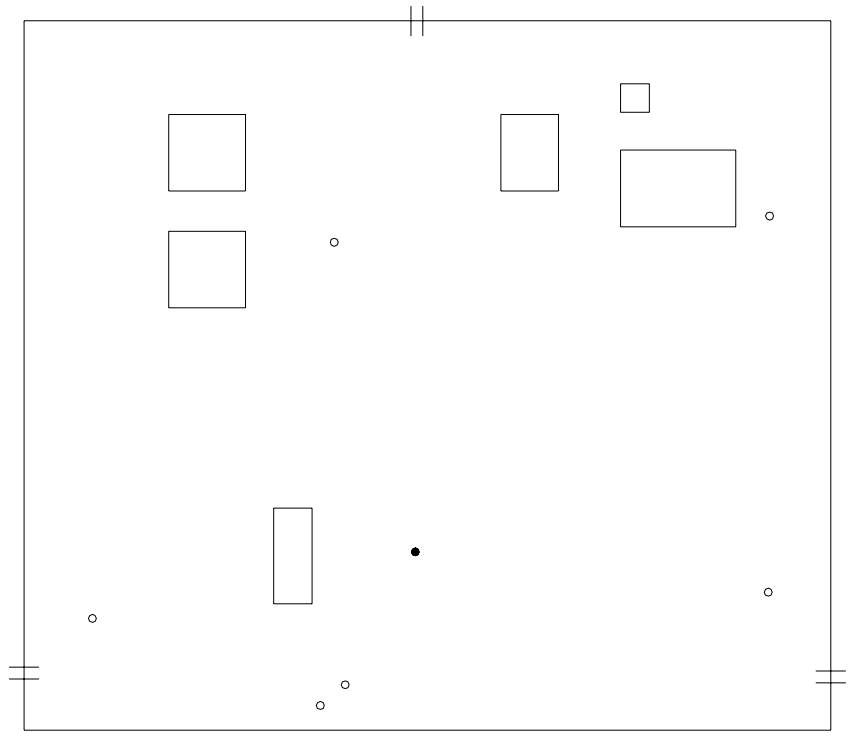

- SYMBOLS KEY**
- ROOF CURB
 - || SCUPPER
 - ROOF DRAIN
 - VENT STACK

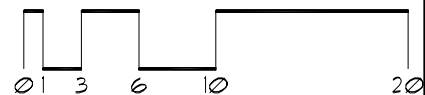

Roof Corrective Action

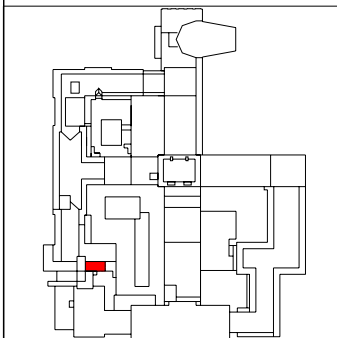
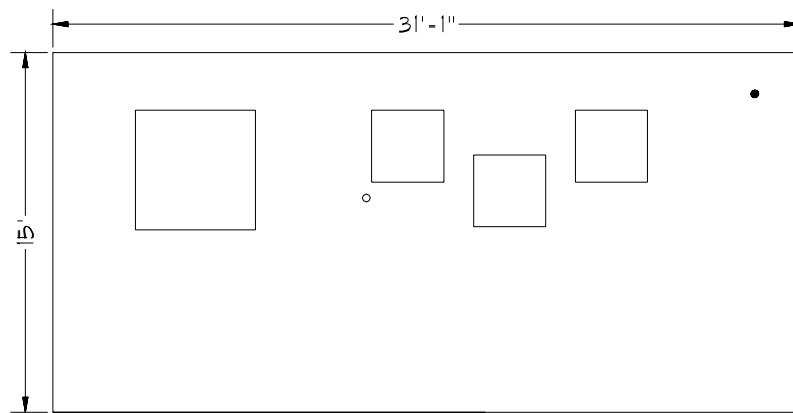

SYMBOLS KEY

- ROOF CURB
- ROOF DRAIN
- VENT STACK

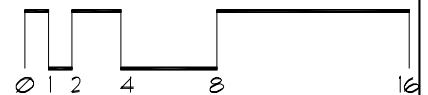

Roof Corrective Action

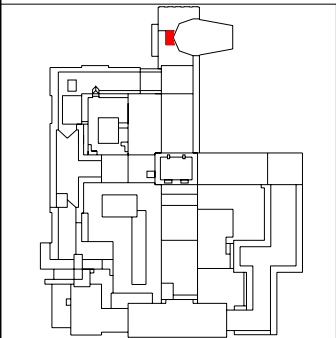
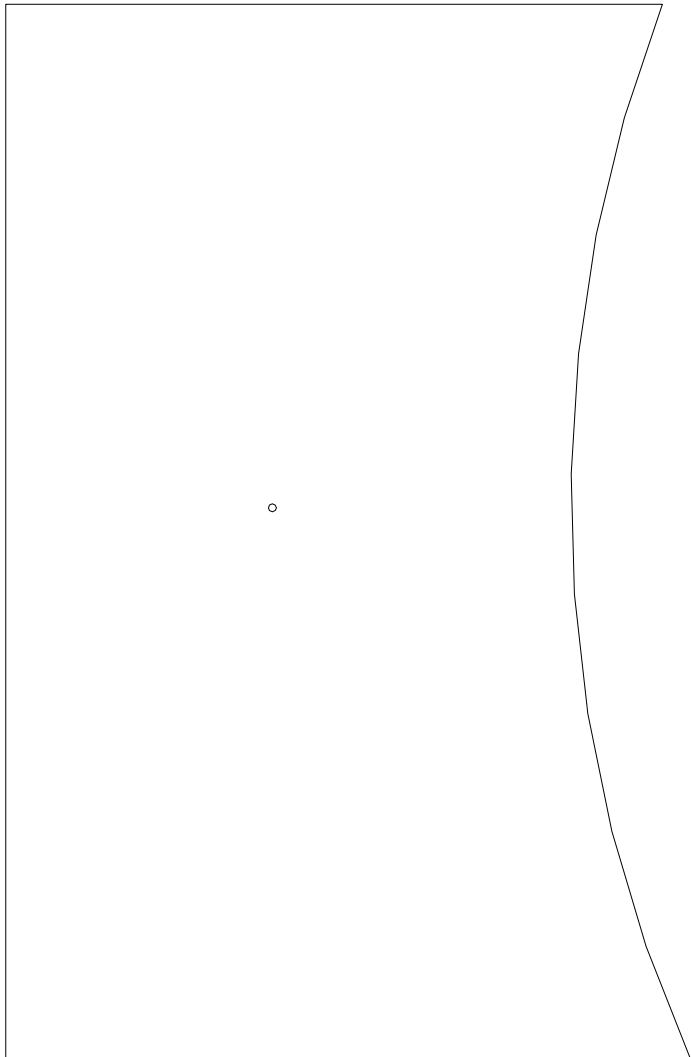

SYMBOLS KEY
| ○ VENT STACK

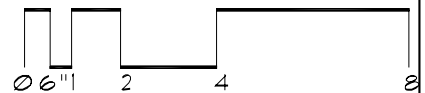

Roof Corrective Action

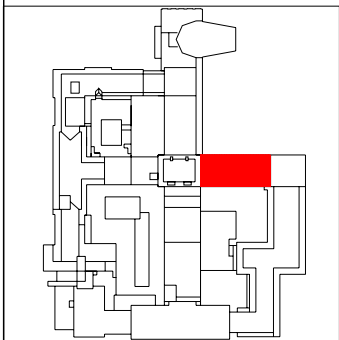
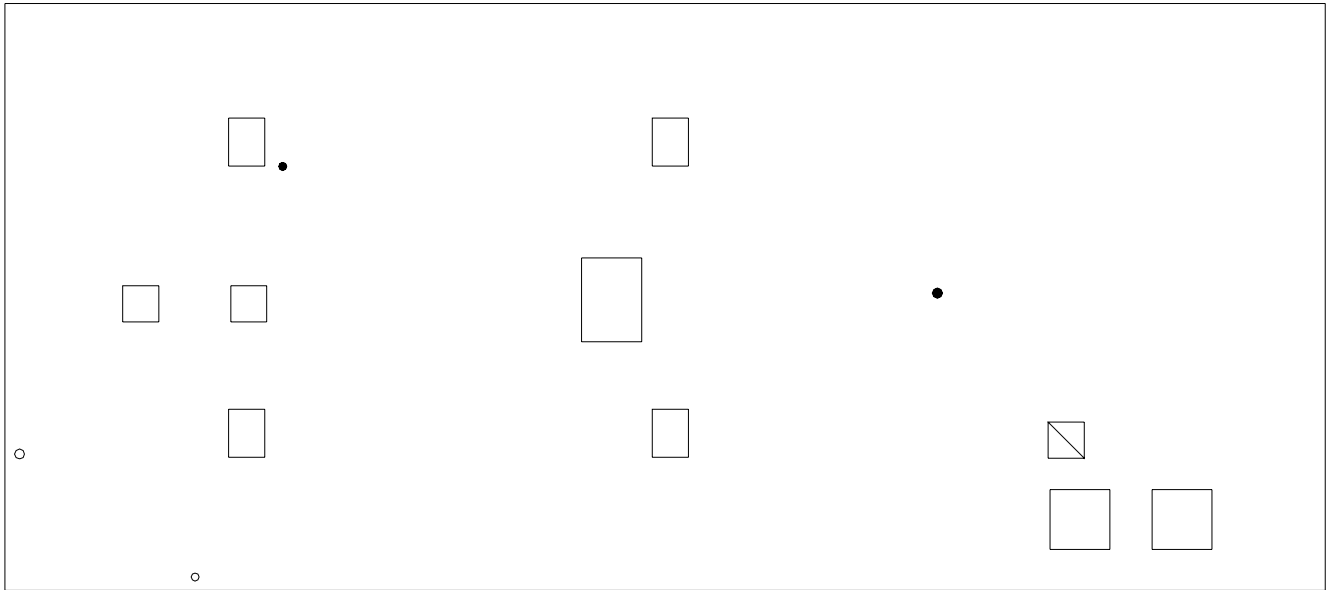

- SYMBOLS KEY**
- ROOF CURB
 - ROOF DRAIN
 - VENT STACK
 - ▣ ROOF HATCH

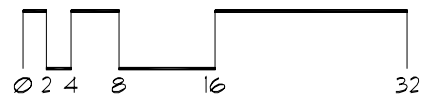

Roof Corrective Action

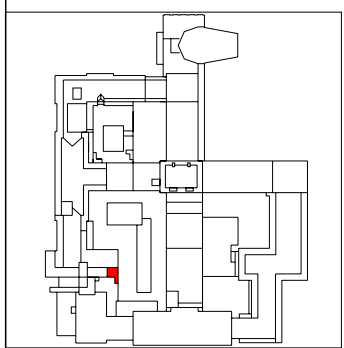
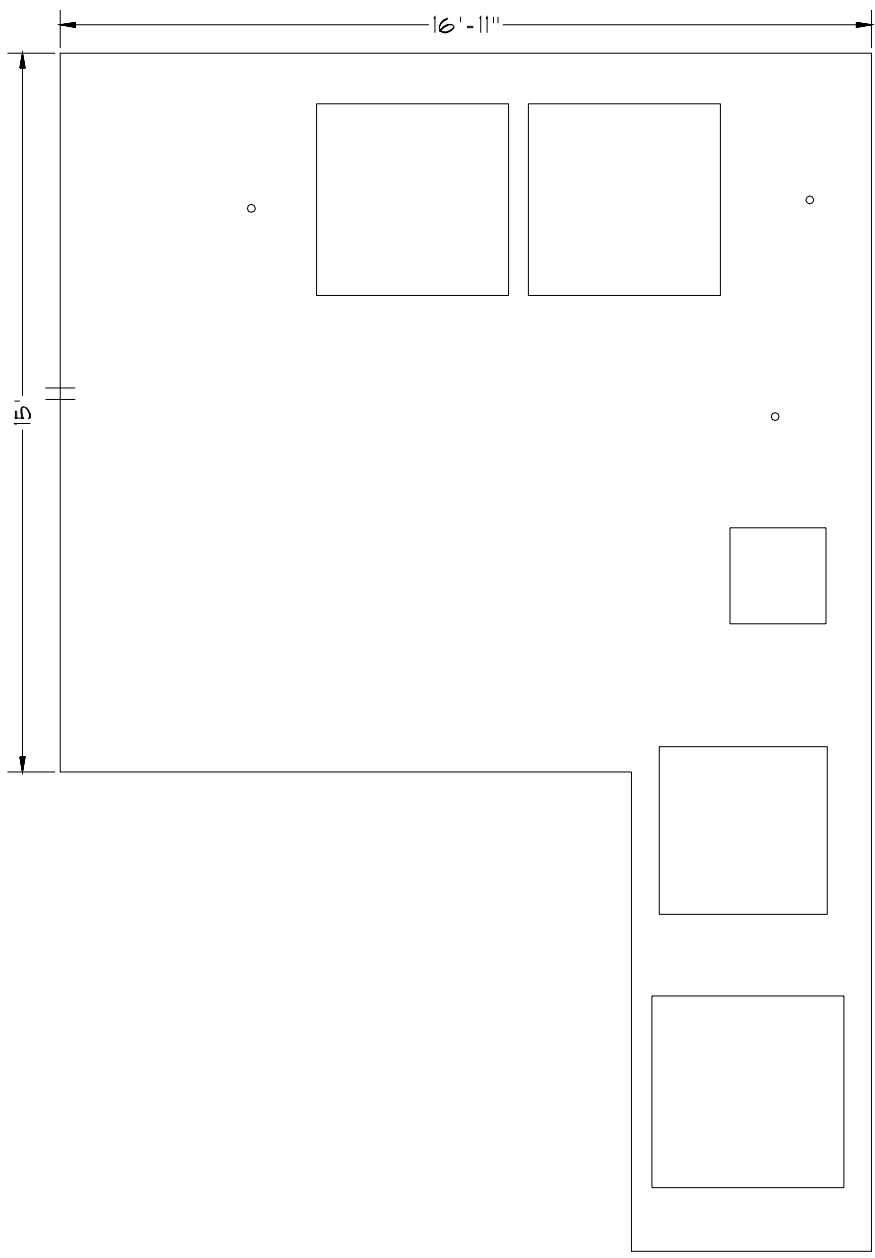

- SYMBOLS KEY**
- ROOF CURB
 - ROOF DRAIN
 - VENT STACK
 - ⊕ SCUPPER
 - ⊖ DEFECT-REPAIR

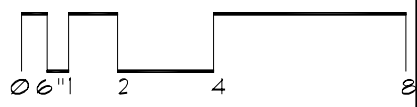

Roof Corrective Action

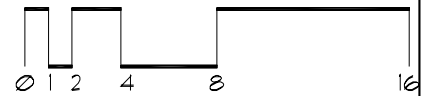
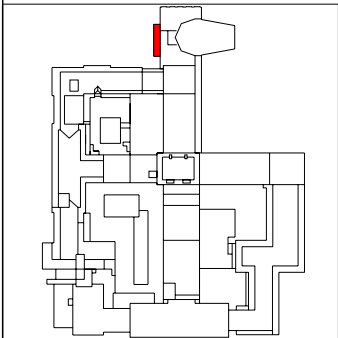
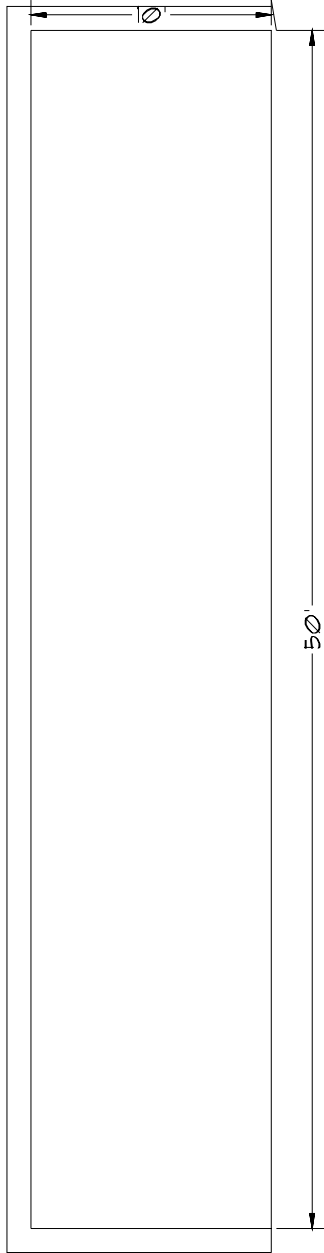

Roof Corrective Action

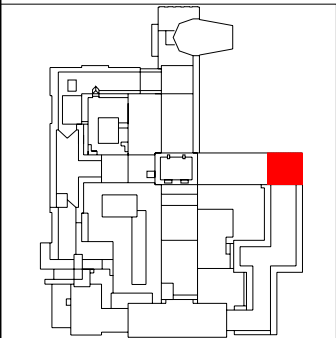
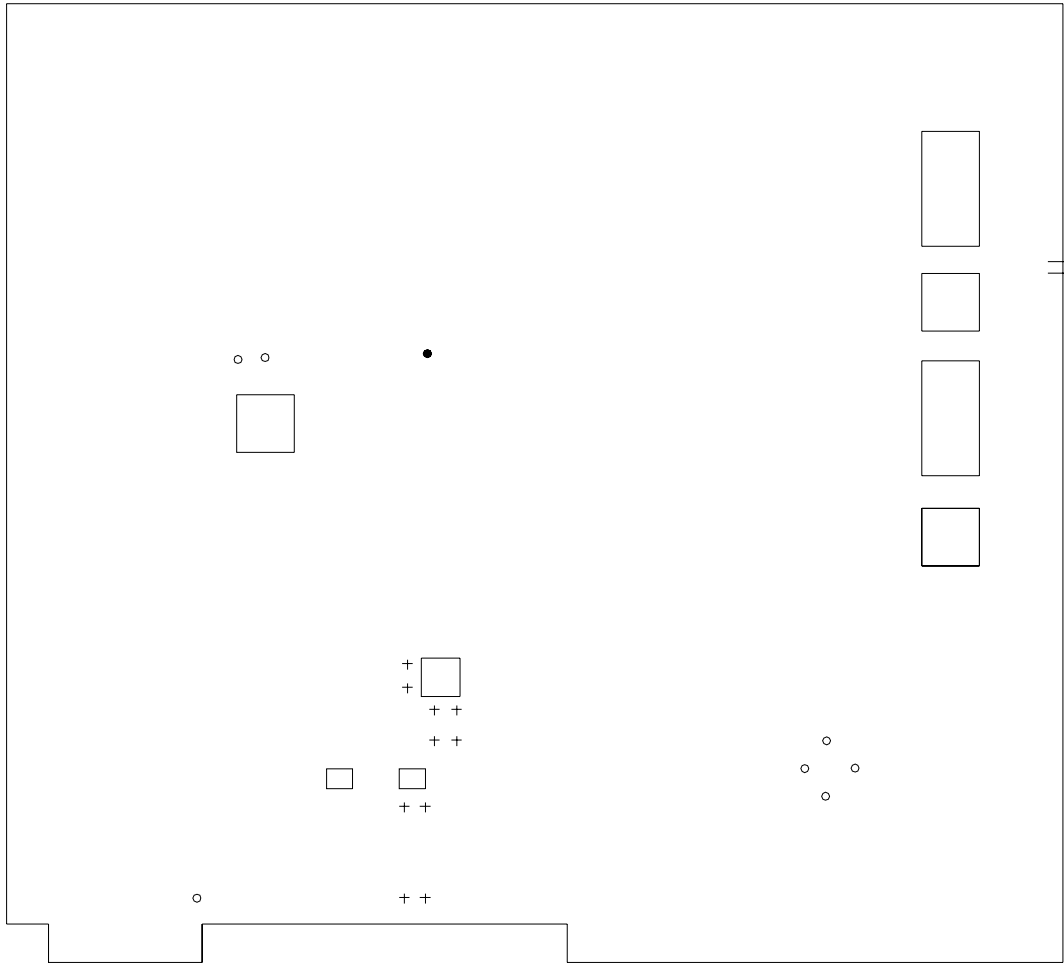

SYMBOLS KEY

- ROOF CURB
 - ROOF DRAIN
 - VENT STACK
 - +
- FLASHED PENETRATION

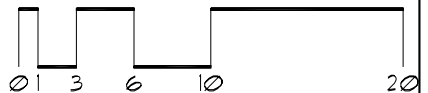

Roof Corrective Action

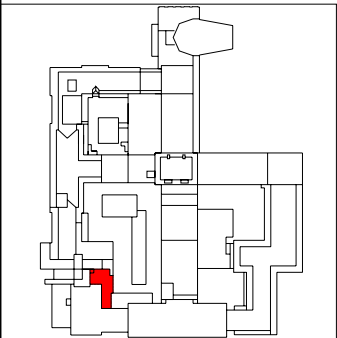
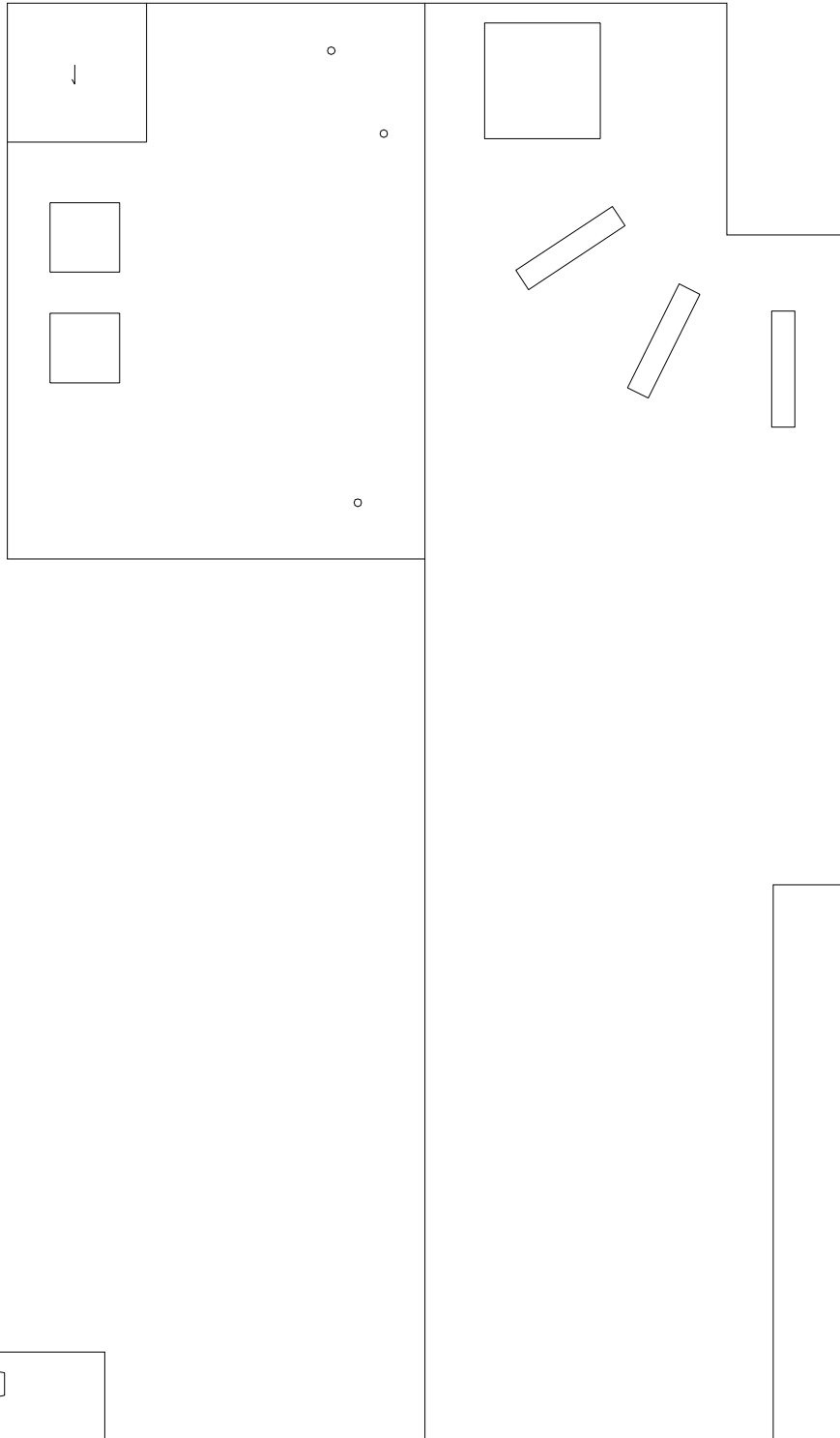

- SYMBOLS KEY**
- ROOF CURB
 - VENT STACK
 - SLOPE DIRECTION
 - Ⓢ DEFECT-REPAIR

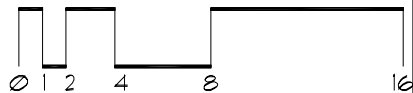

Roof Corrective Action

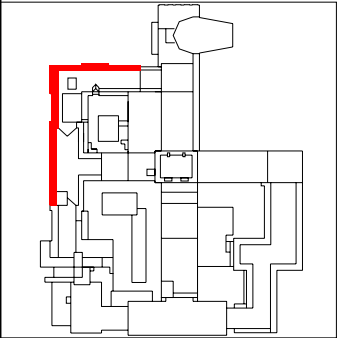
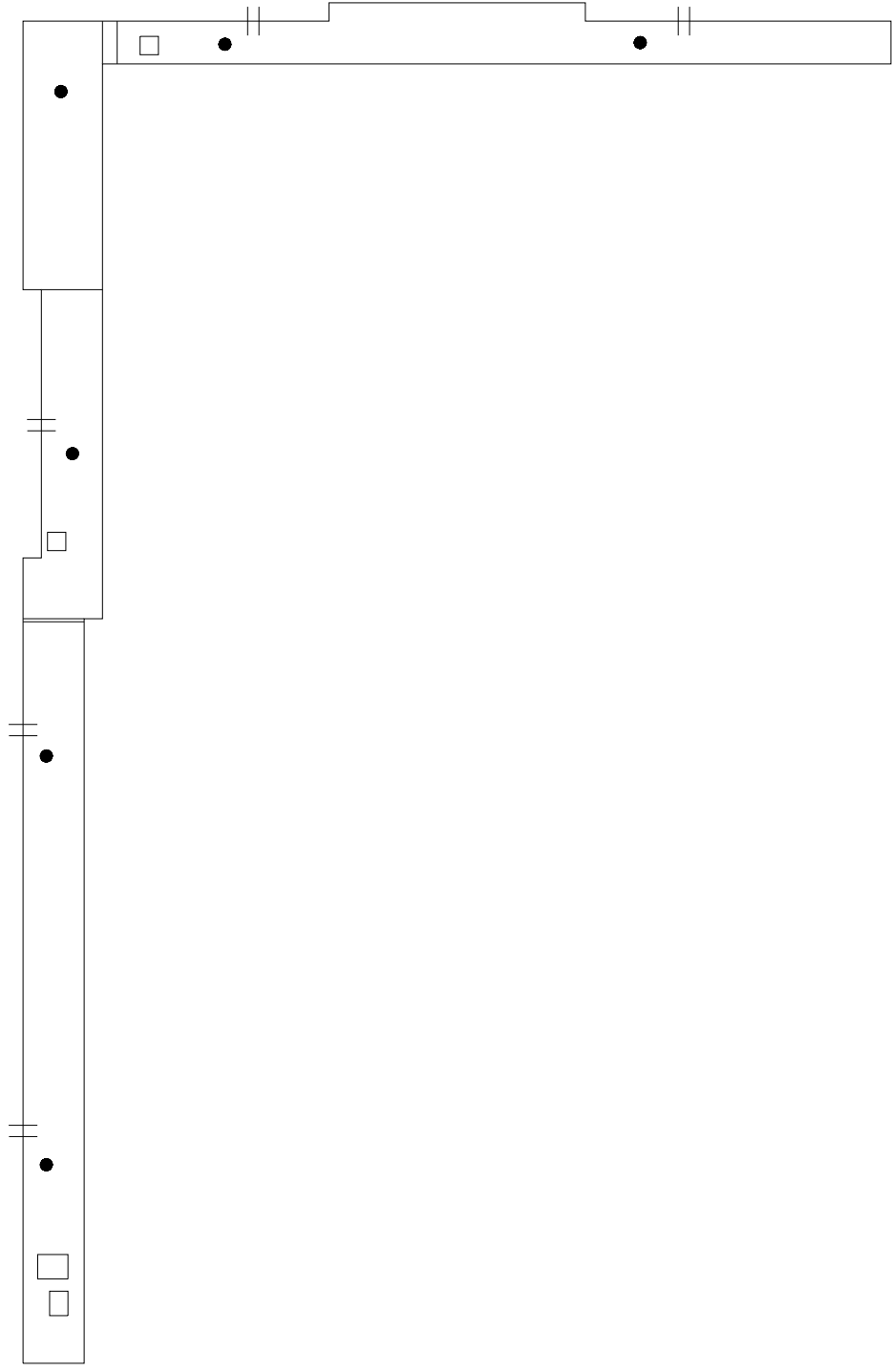

- SYMBOLS KEY**
- ROOF CURB
 - ROOF DRAIN
 - || SCUPPER
 - ① DEFECT-REPAIR

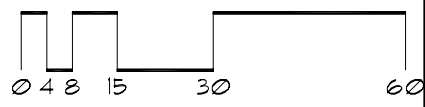

Roof Corrective Action

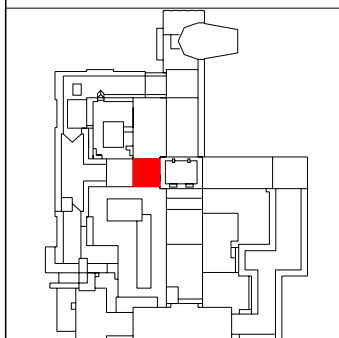
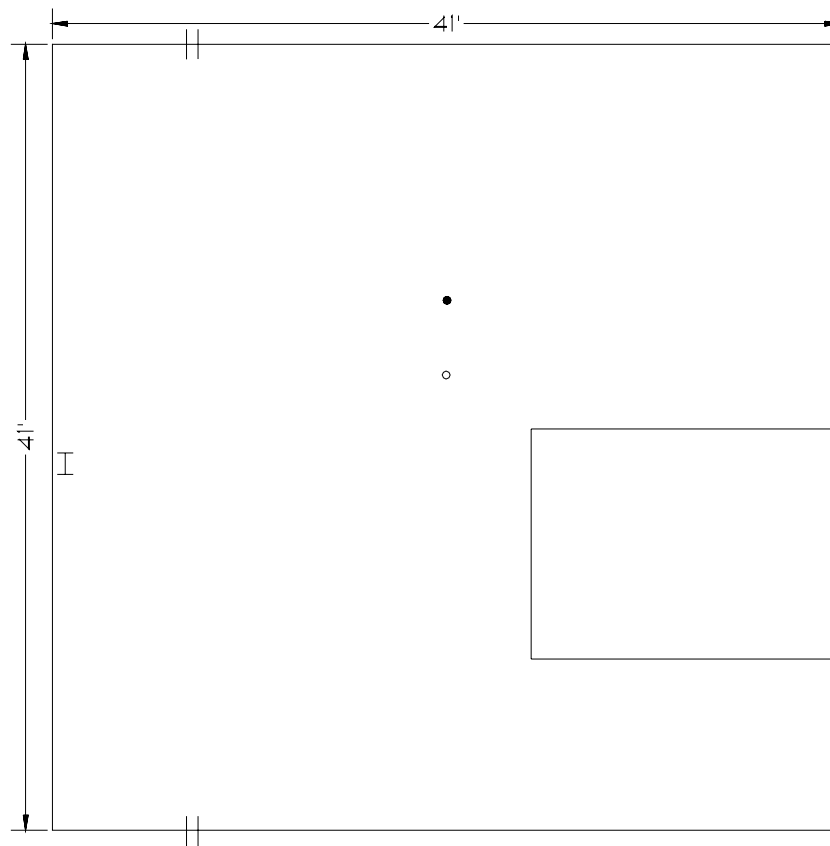

SYMBOLS KEY

- ROOF DRAIN
- VENT STACK
- ⊕ SCUPPER
- ⊖ DEFECT-NO REPAIR
- ⊙ DEFECT-REPAIR
- I LADDER

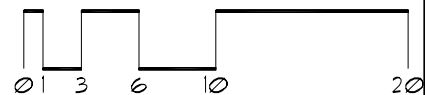

Roof Corrective Action

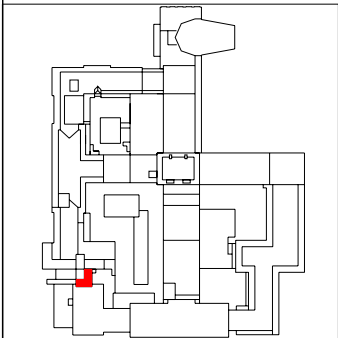
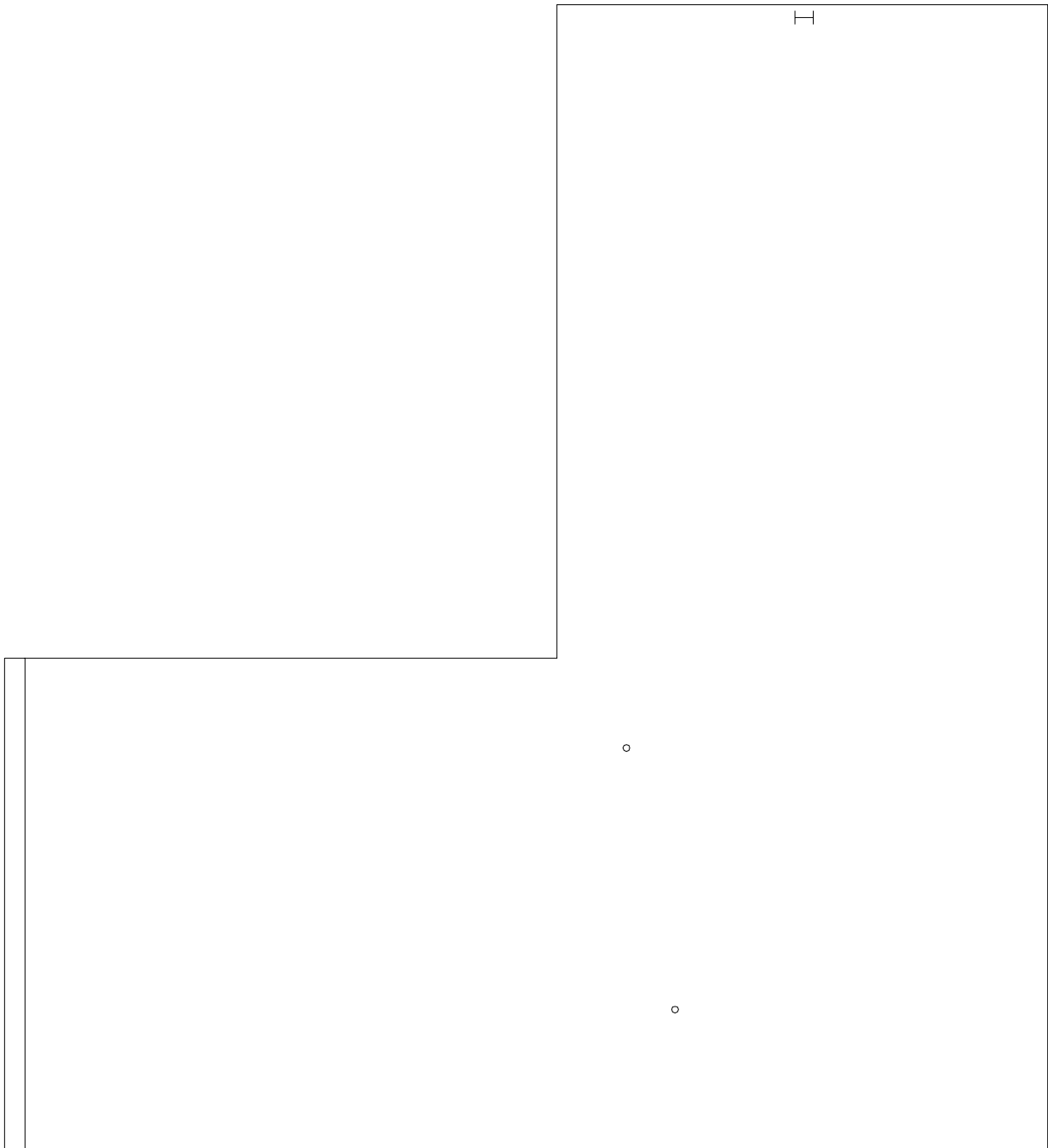

SYMBOLS KEY

- VENT STACK
- I LADDER

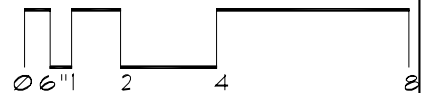

Roof Corrective Action

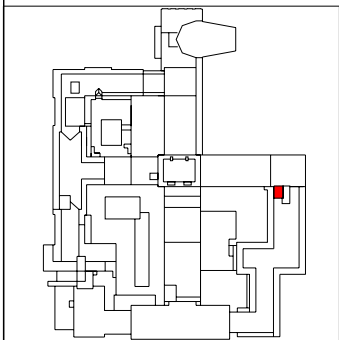
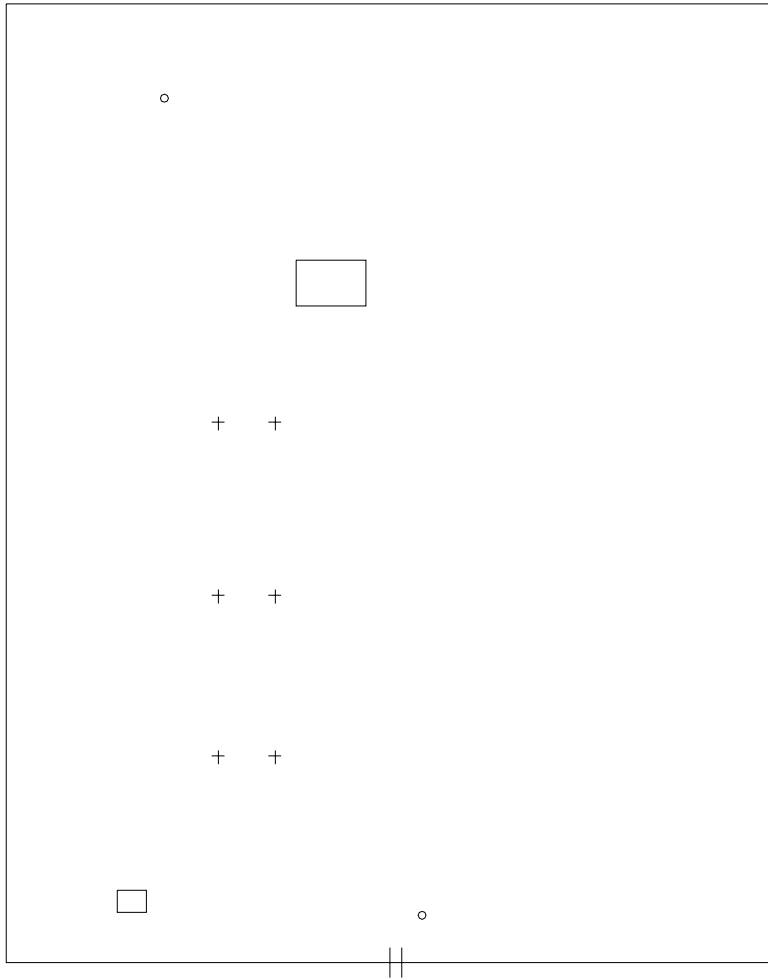

SYMBOLS KEY

- ⊥ SCUPPER
- VENT STACK
- ⊕ FLASHED PENETRATION
- DEFECT-REPAIR

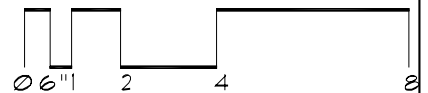

Roof Corrective Action

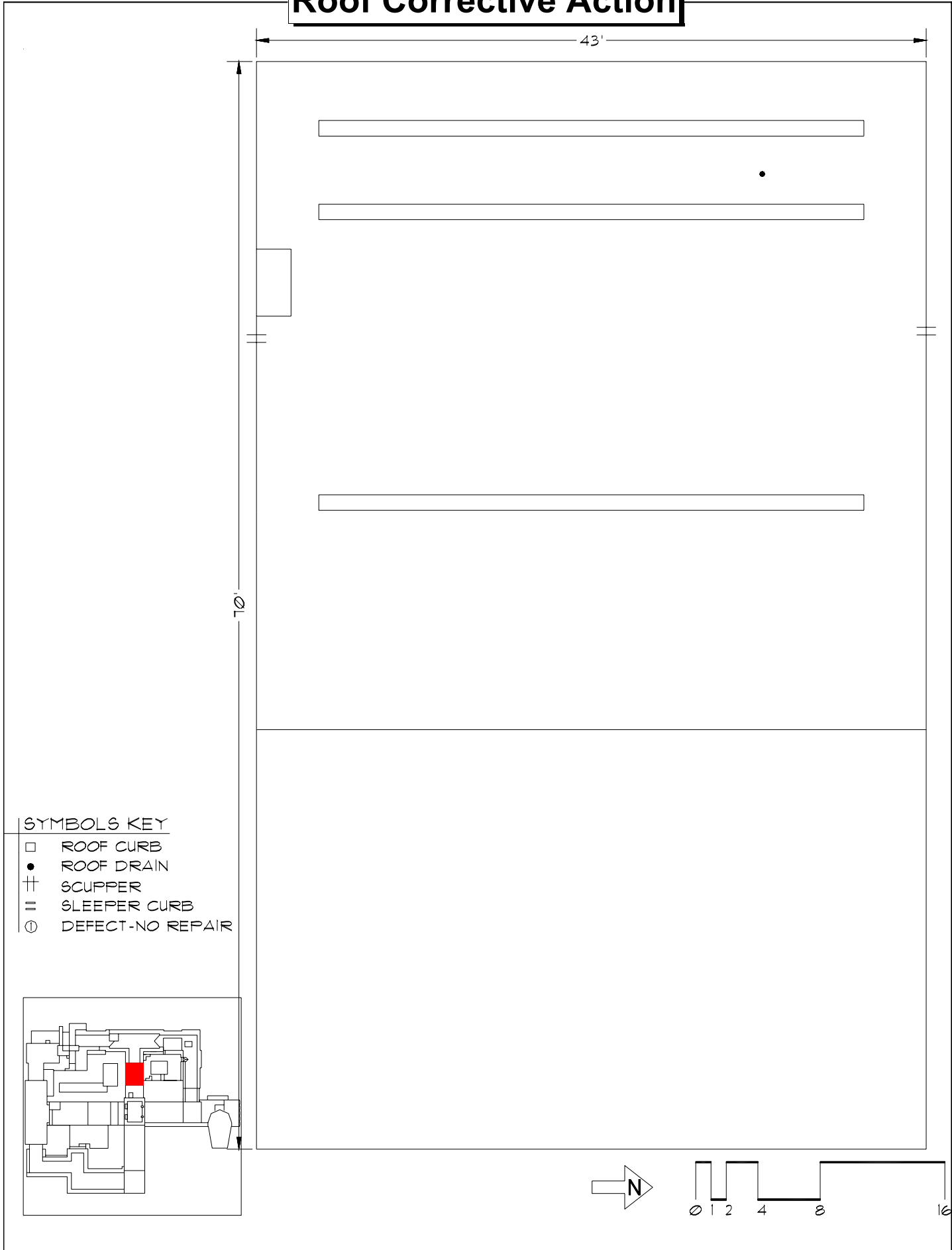

Roof Corrective Action

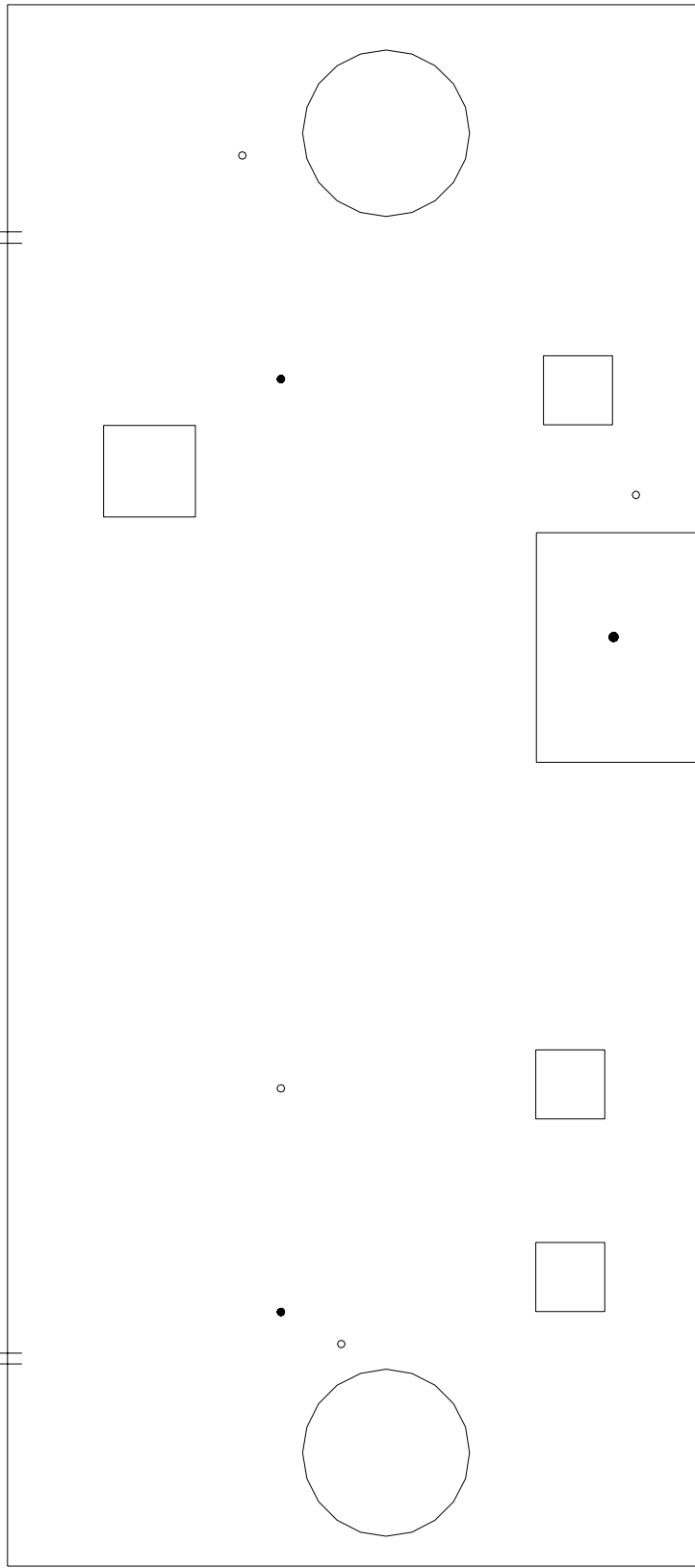

SYMBOLS KEY

- ROOF CURB
- ROOF DRAIN
- VENT STACK
- HEAT STACK

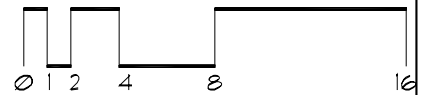
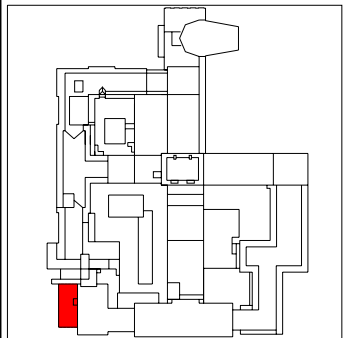

Roof Corrective Action

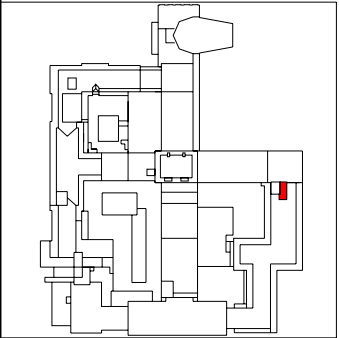
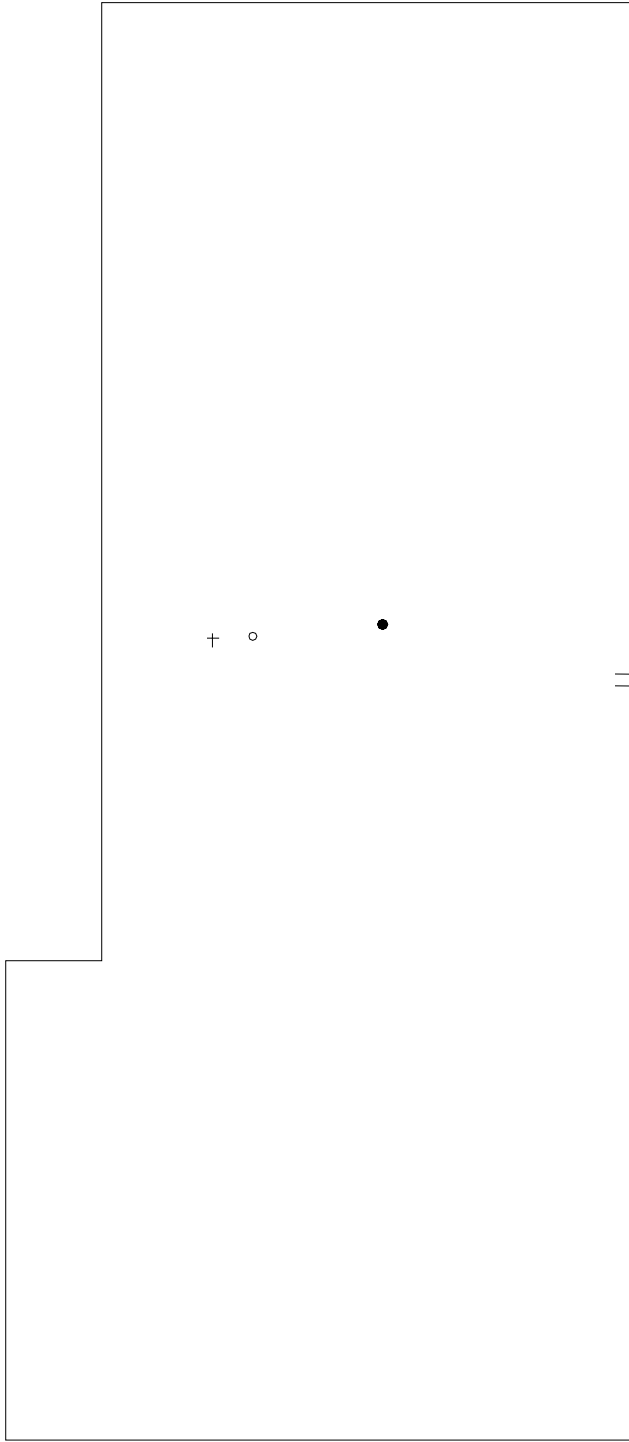

SYMBOLS KEY

- ROOF DRAIN
- o VENT STACK
- Ⓜ DEFECT-REPAIR

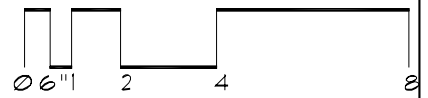

Roof Corrective Action

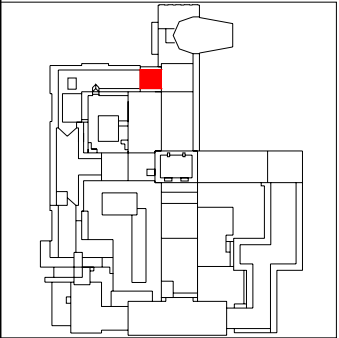
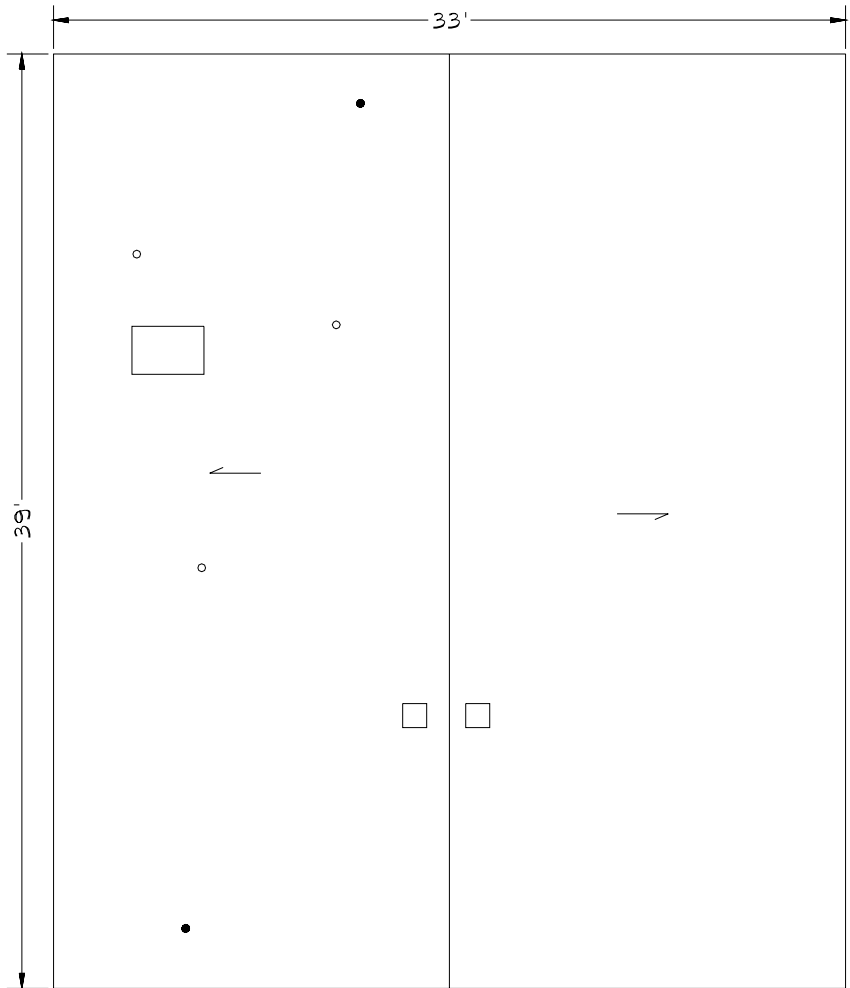

- SYMBOLS KEY**
- ROOF CURB
 - VENT STACK
 - ↘ SLOPE DIRECTION

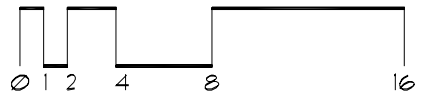

Roof Corrective Action

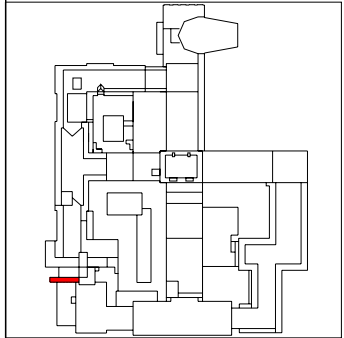
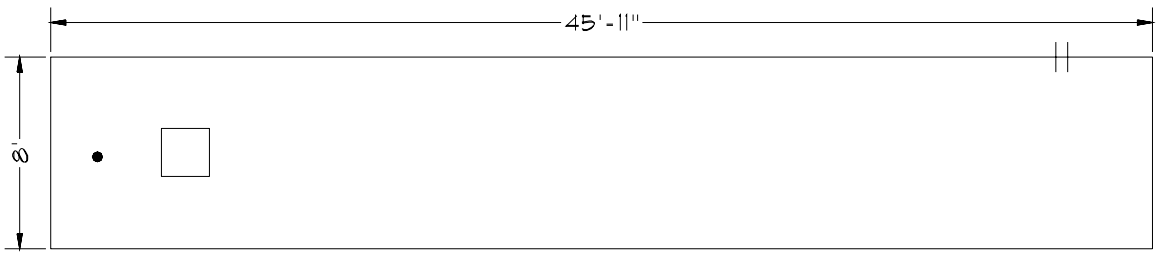

- SYMBOLS KEY**
- ROOF CURB
 - ROOF DRAIN
 - ≡ SCUPPER
 - ⊖ DEFECT-REPAIR
 - ⊕ DEFECT-NO REPAIR

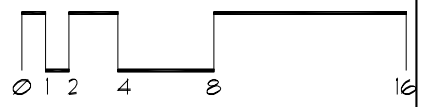

Roof Corrective Action

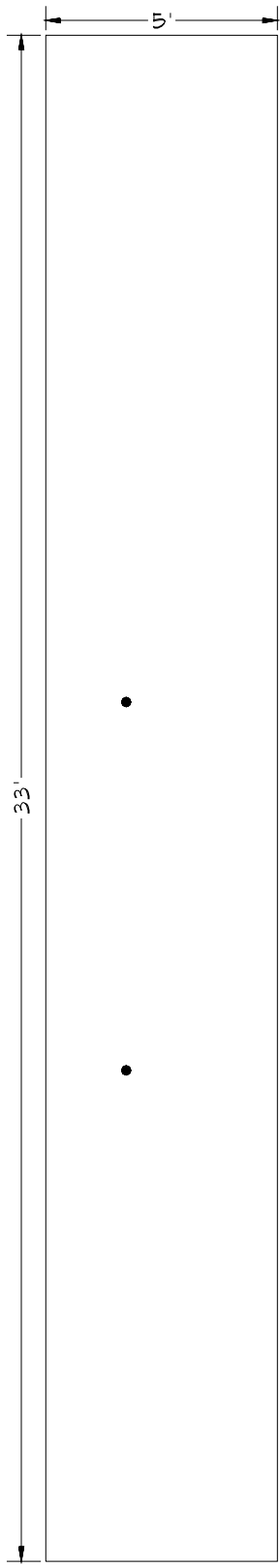

SYMBOLS KEY
● ROOF DRAIN

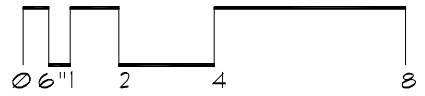
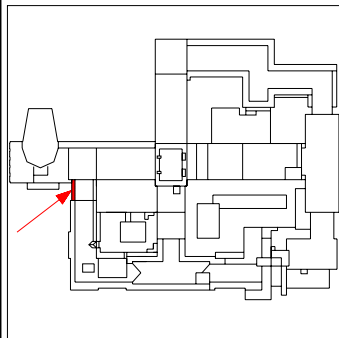

Roof Corrective Action

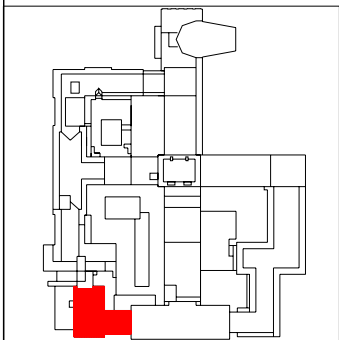
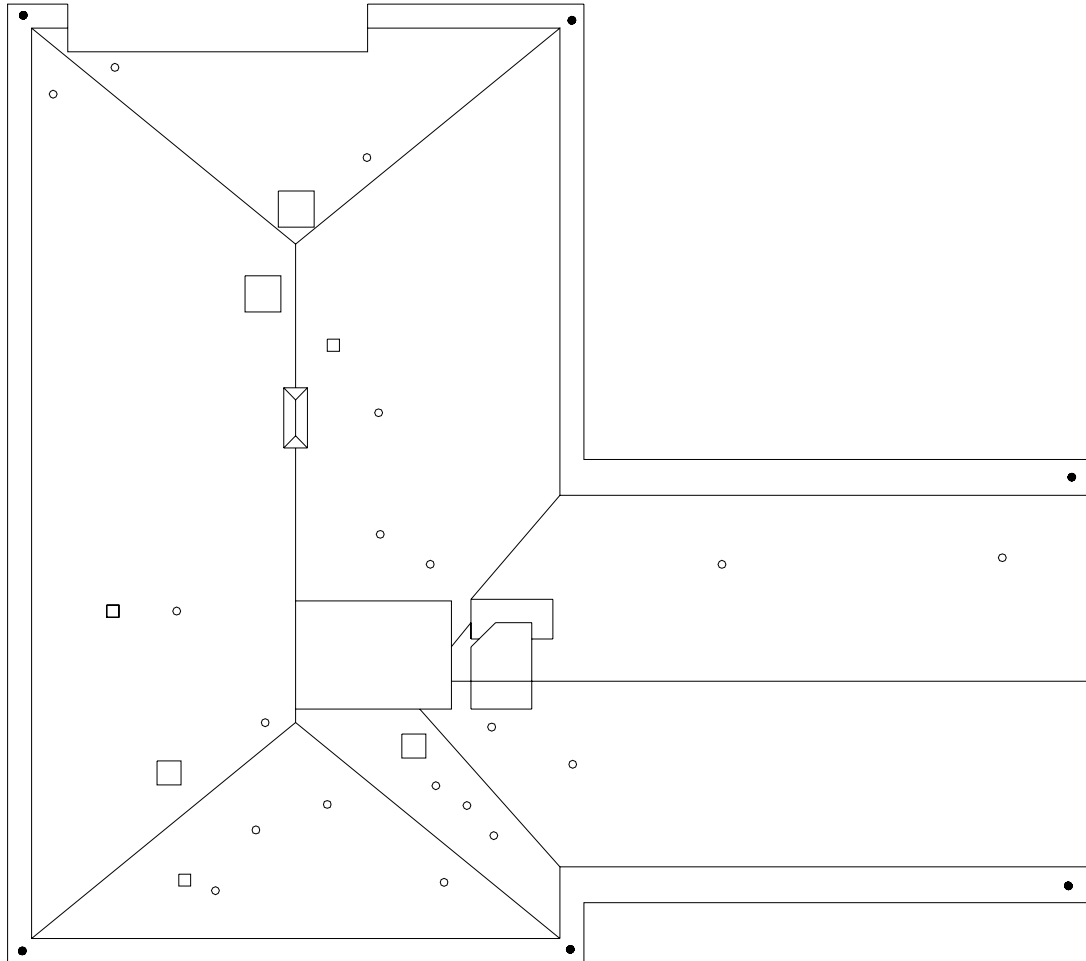

SYMBOLS KEY

- ROOF CURB
- ROOF DRAIN
- VENT STACK
- Ⓜ DEFECT-REPAIR

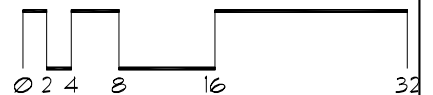

Roof Corrective Action

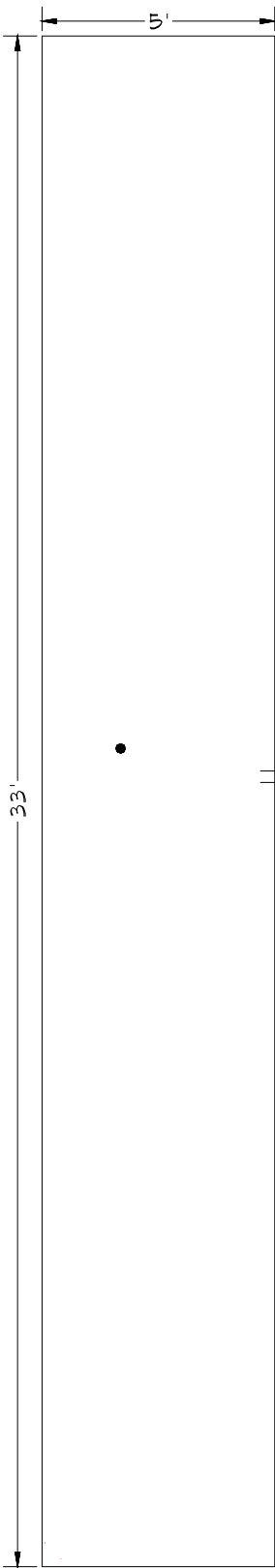

SYMBOLS KEY

- ⊥ SCUPPER
- ROOF DRAIN
- Ⓢ DEFECT-REPAIR

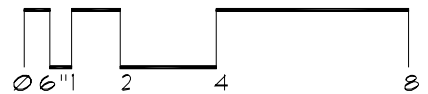
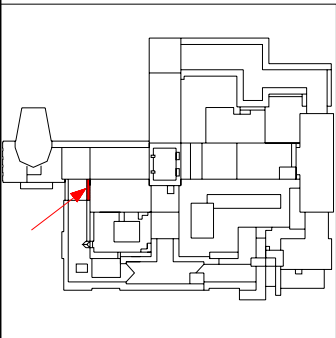

Roof Corrective Action

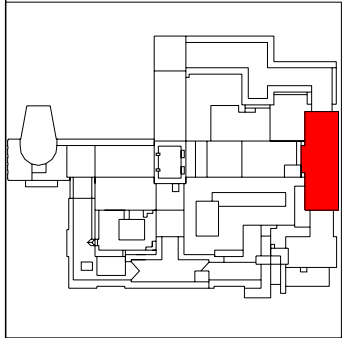
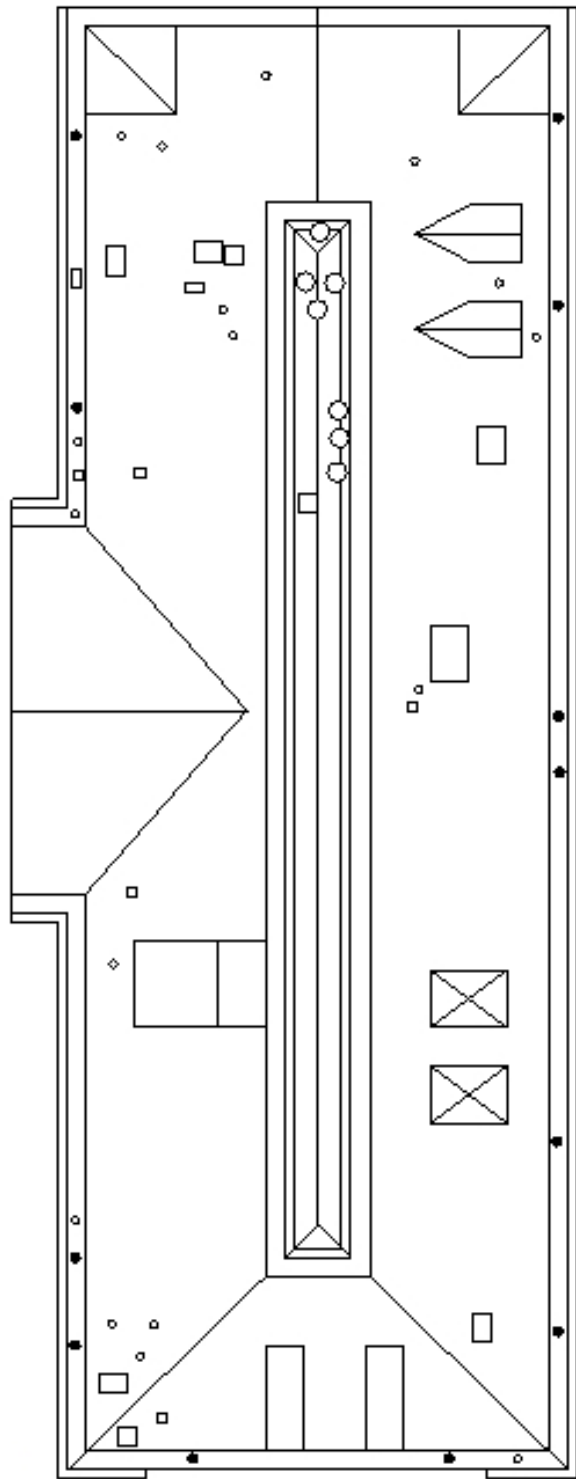

- SYMBOLS KEY**
- ROOF CURB
 - ROOF DRAIN
 - VENT STACK
 - ⊖ DEFECT-NO REPAIR
 - ⊕ DEFECT-REPAIR

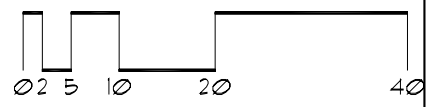

Roof Corrective Action

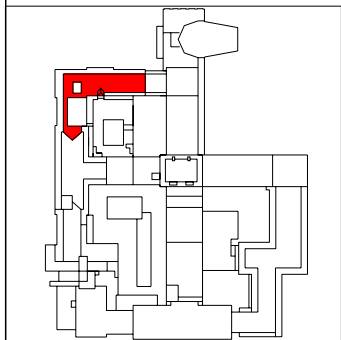
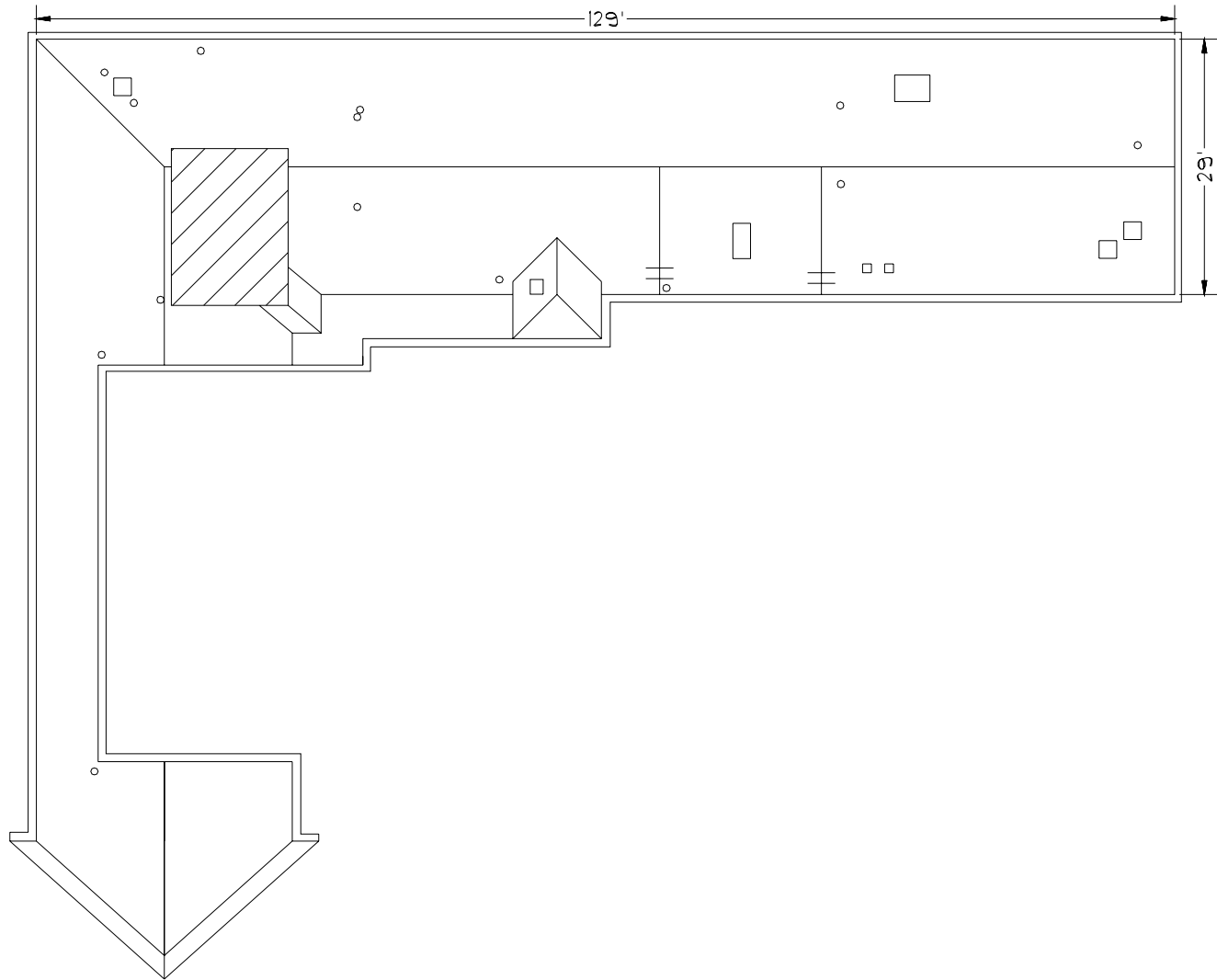

SYMBOLS KEY

- ROOF CURB
- VENT STACK
- ≡ SCUPPER

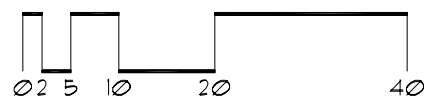

Roof Corrective Action

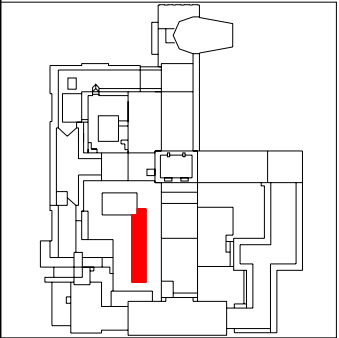
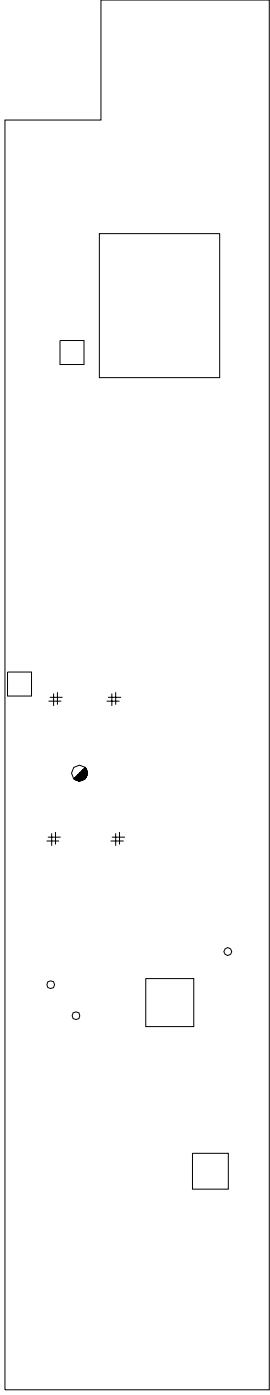

SYMBOLS KEY

- ROOF CURB
- VENT STACK
- # PITCH PAN
- HEAT STACK



Roof Corrective Action

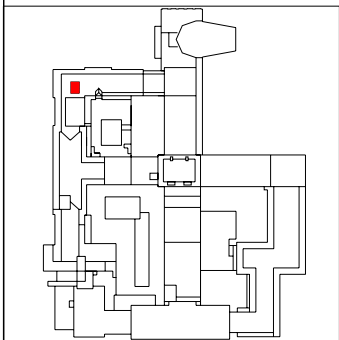
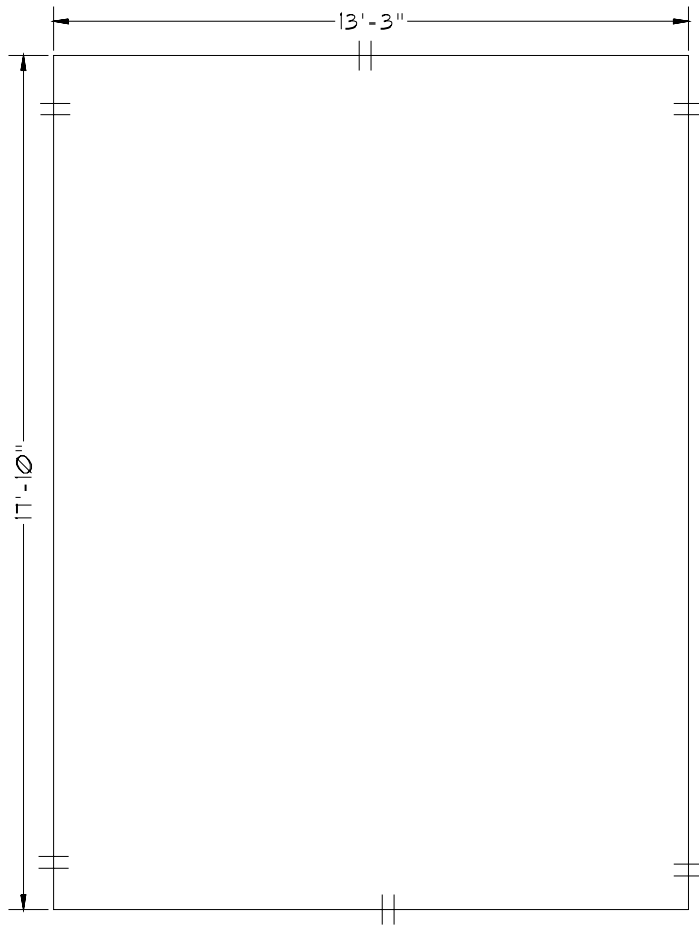

SYMBOLS KEY
|| SCUPPER

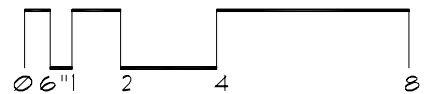

Roof Corrective Action

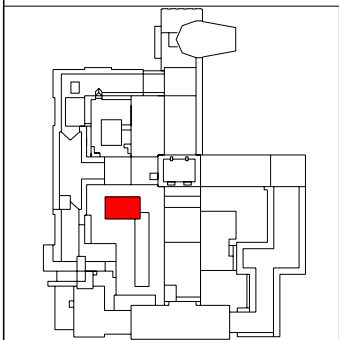

SYMBOLS KEY
| ○ VENT STACK

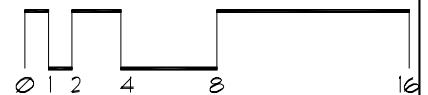

Roof Corrective Action

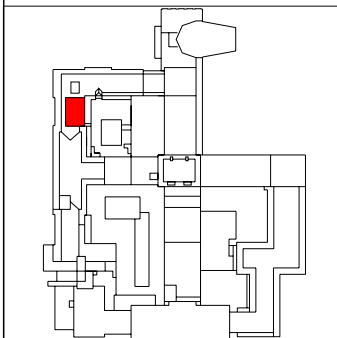
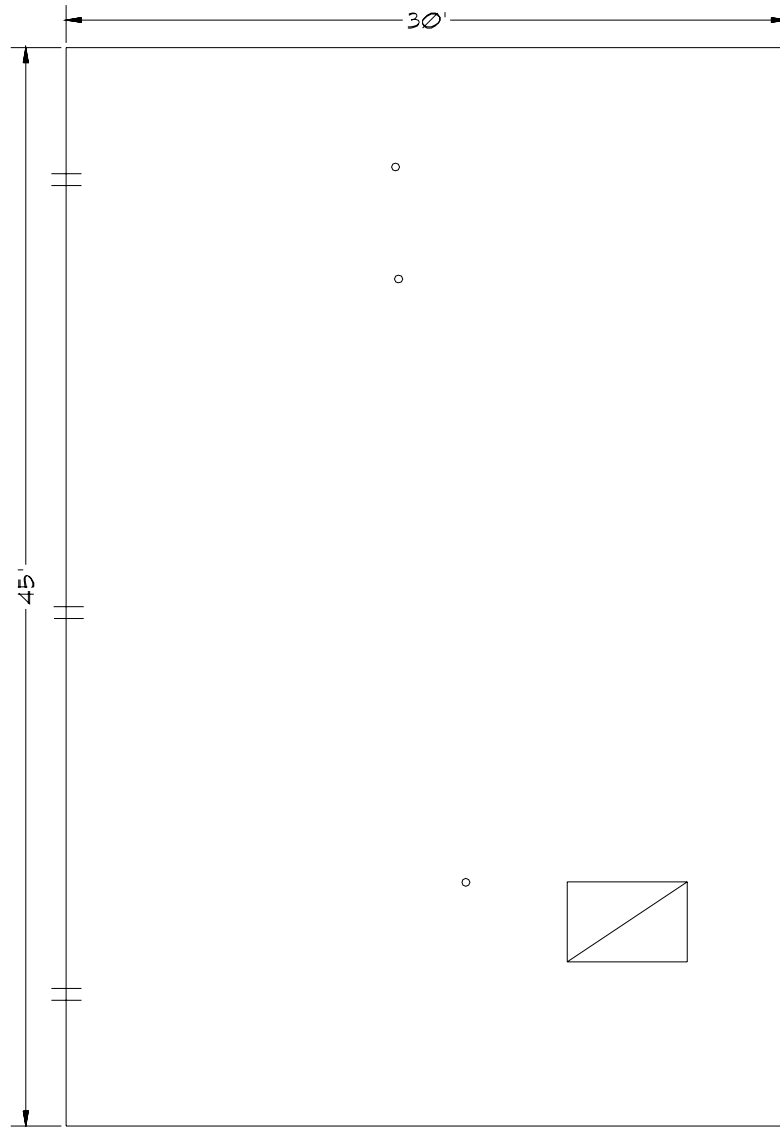

SYMBOLS KEY

- VENT STACK
- ≡ SCUPPER
- ◻ ROOF HATCH
- ⊖ DEFECT-NO REPAIR

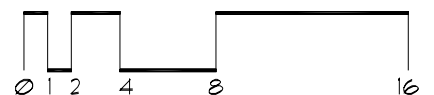

Roof Corrective Action

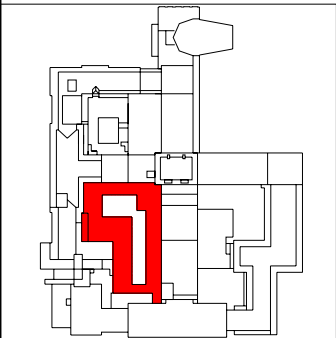
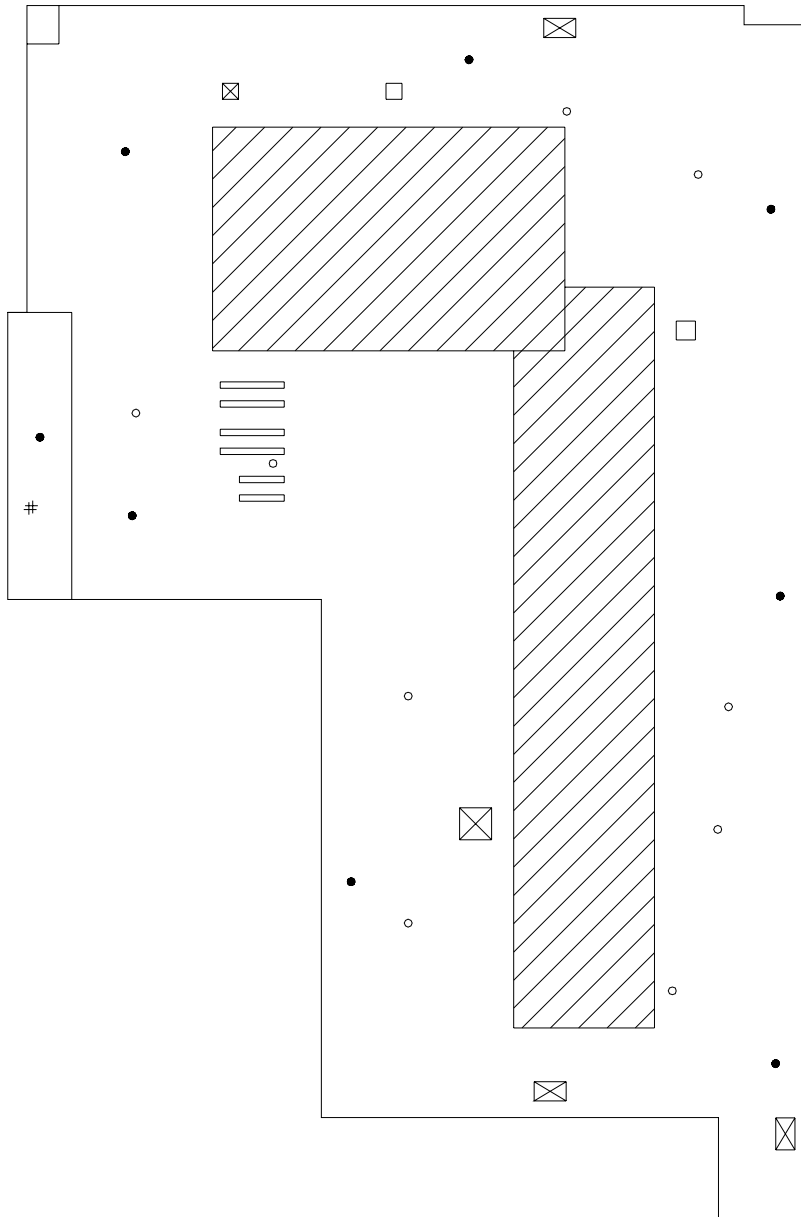

SYMBOLS KEY

- ROOF CURB
- ROOF DRAIN
- VENT STACK
- LEAK LOCATION
- # PITCH PAN
- ⊠ SKYLIGHT
- Ⓢ DEFECT-REPAIR

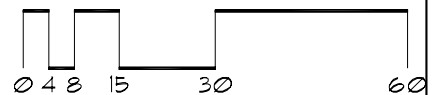

Roof Corrective Action

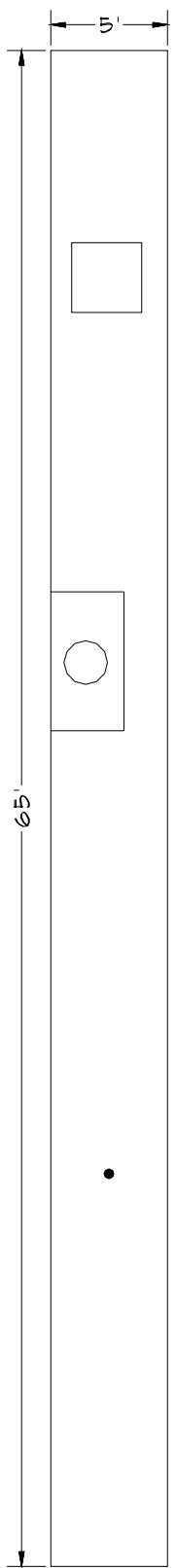

SYMBOLS KEY

- ROOF CURB
- ROOF DRAIN
- ⊕ DEFECT-NO REPAIR

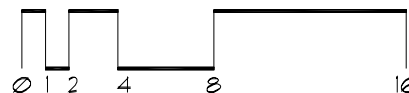
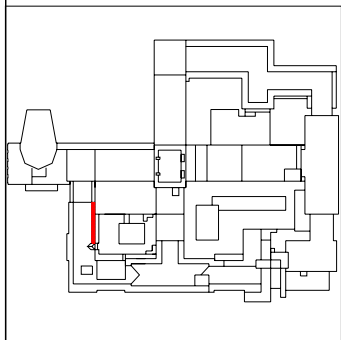

Roof Corrective Action

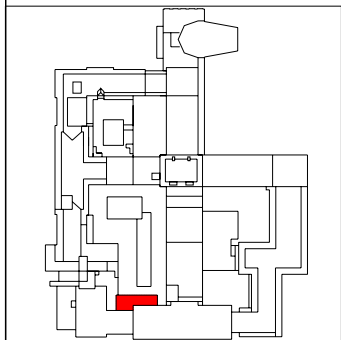
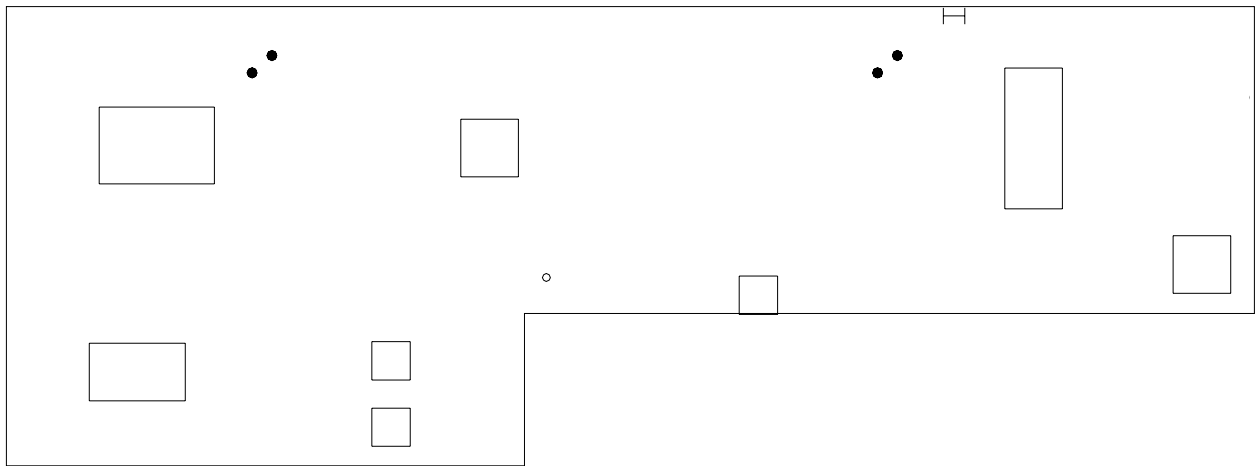

- SYMBOLS KEY**
- ROOF CURB
 - ROOF DRAIN
 - VENT STACK
 - Ⓜ DEFECT-REPAIR

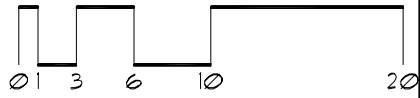

Roof Corrective Action

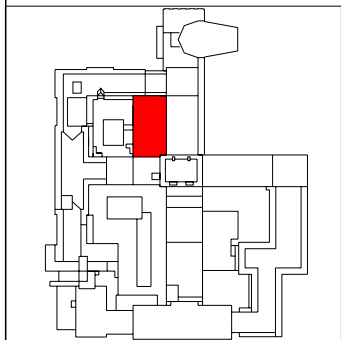
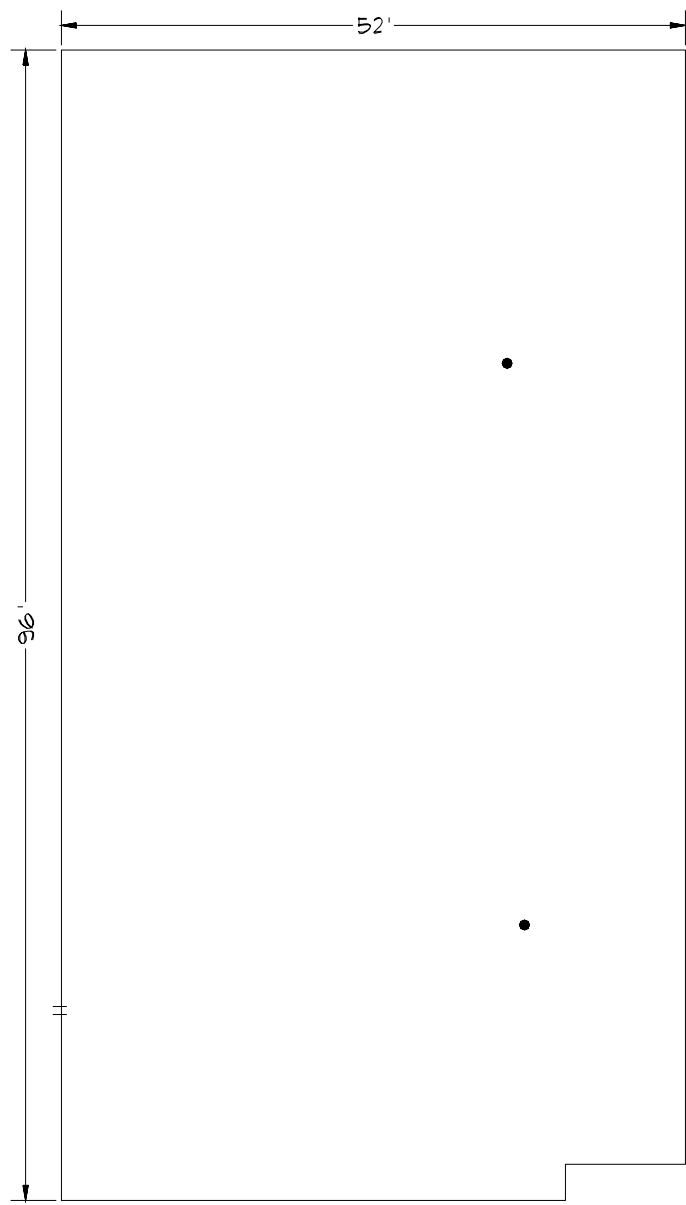

SYMBOLS KEY

- ROOF DRAIN
- † SCUPPER
- ⓪ DEFECT-NO REPAIR

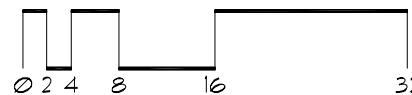

Roof Corrective Action

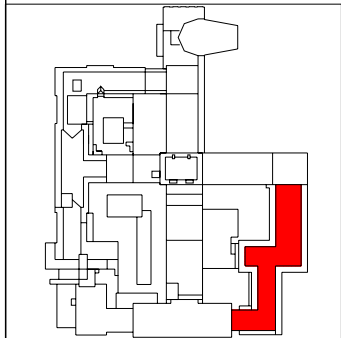
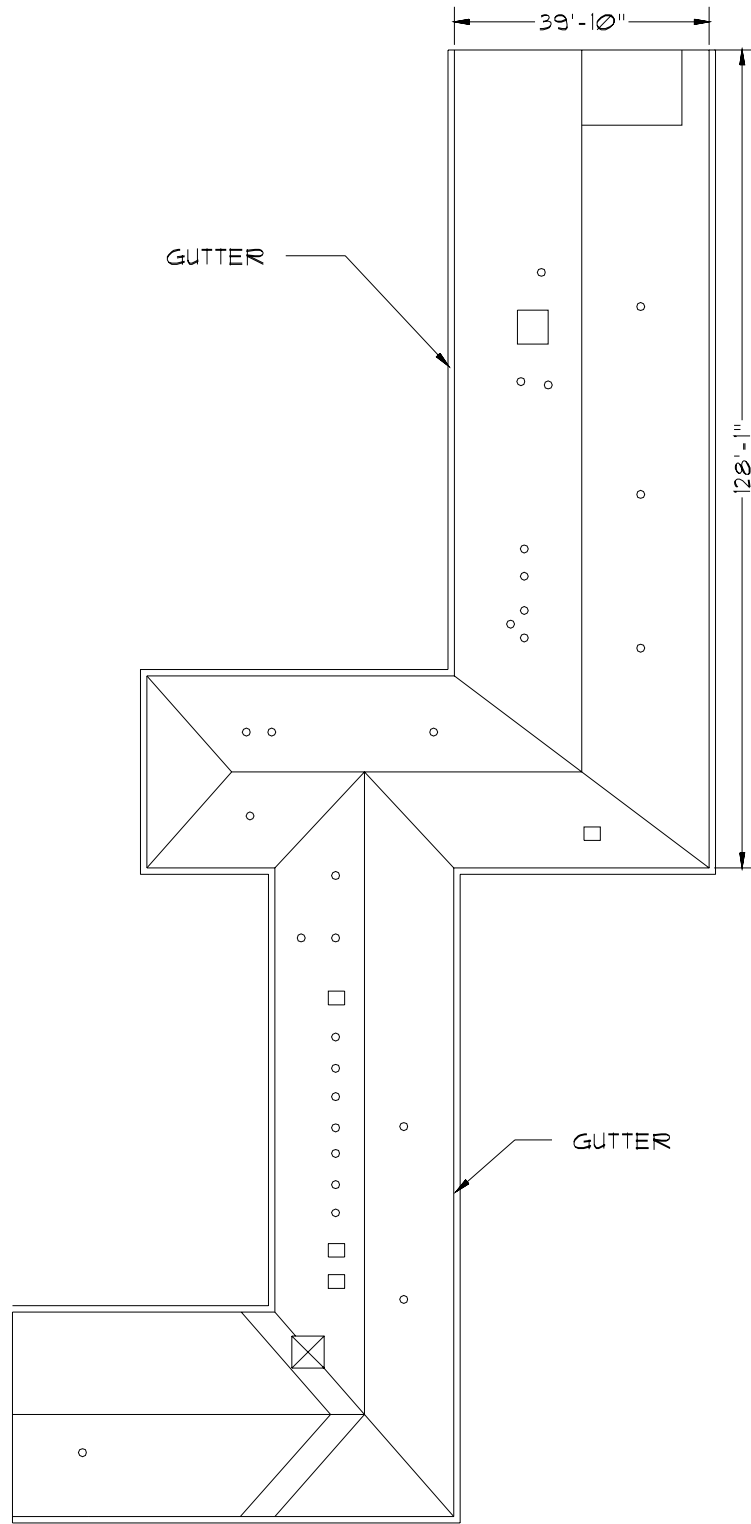

- SYMBOLS KEY**
- ROOF CURB
 - VENT STACK

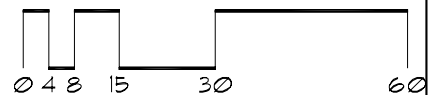

Roof Corrective Action

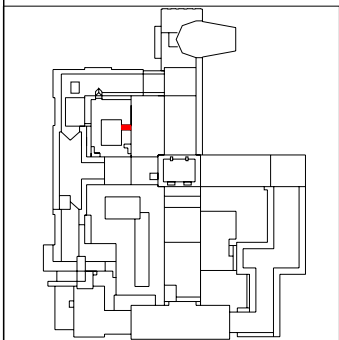
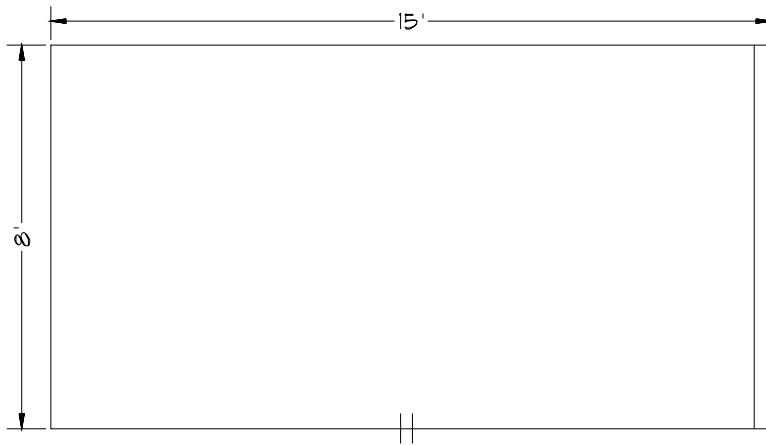

SYMBOLS KEY
|| SCUPPER

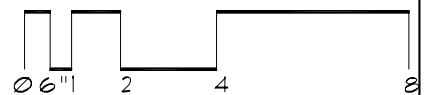
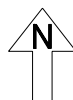

Roof Corrective Action

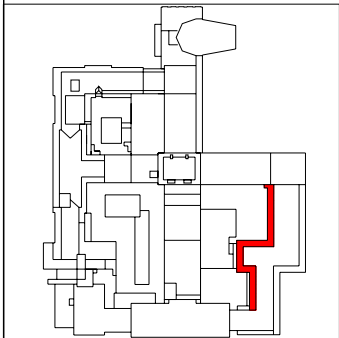
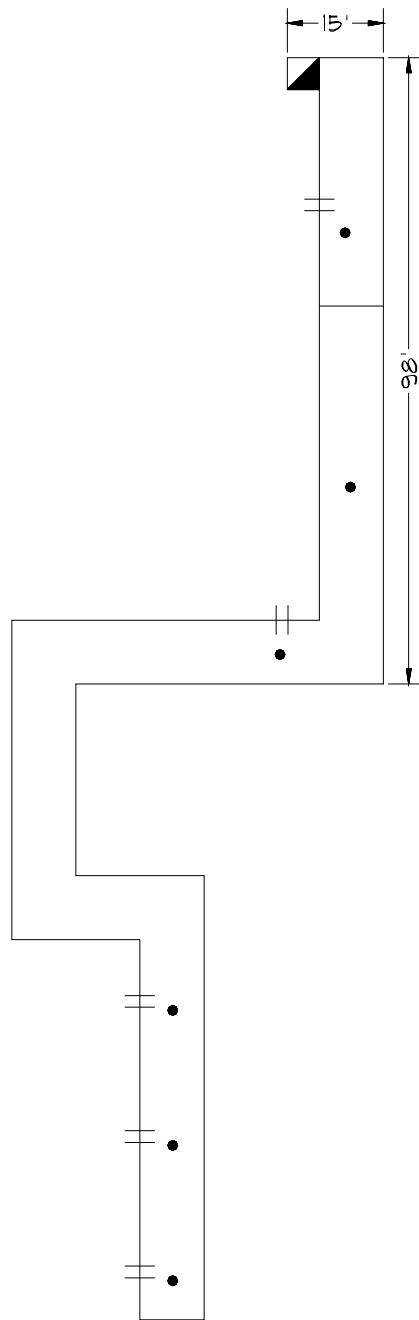

- SYMBOLS KEY
- || SCUPPER
 - ROOF DRAIN
 - Ⓢ DEFECT-REPAIR

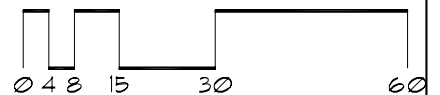

Roof Corrective Action

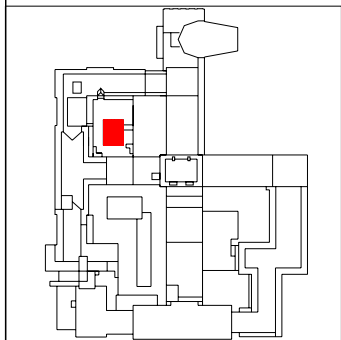
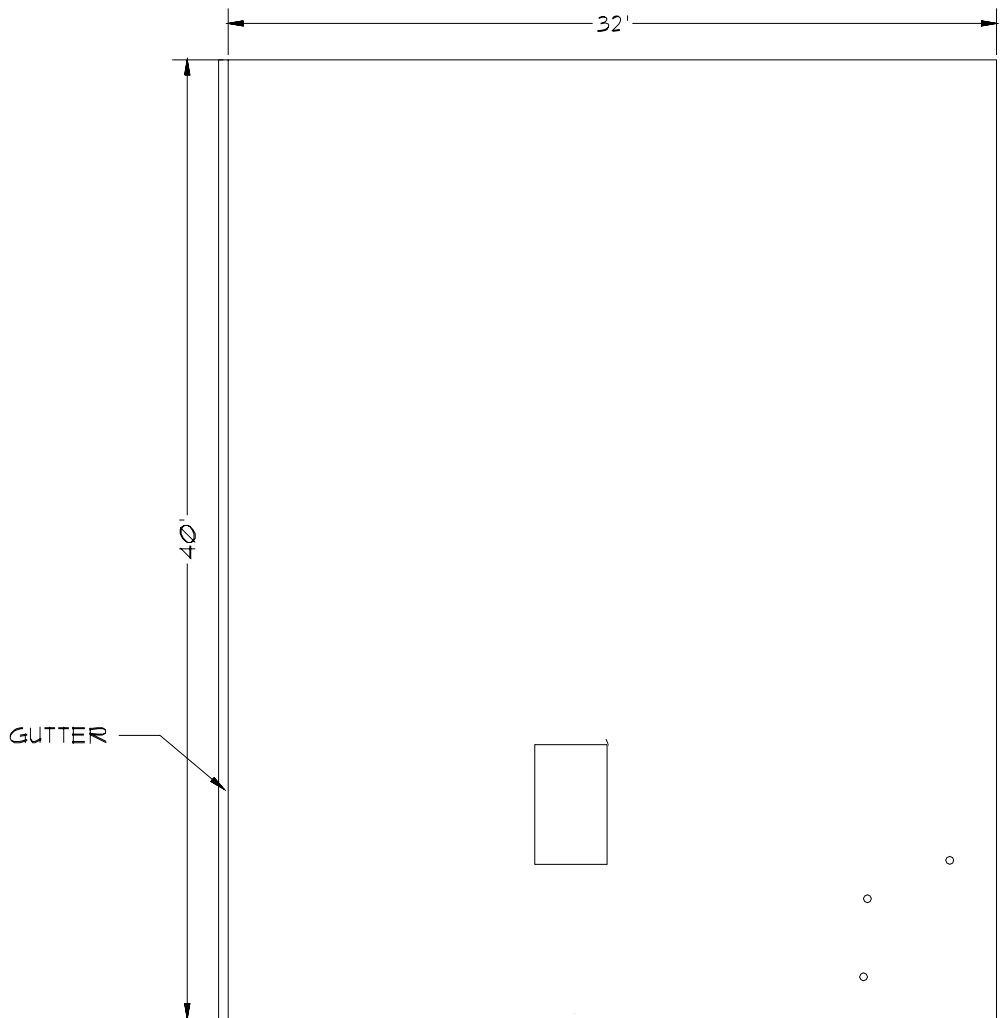

SYMBOLS KEY

- ROOF CURB
- VENT STACK
- ① DEFECT-NO REPAIR

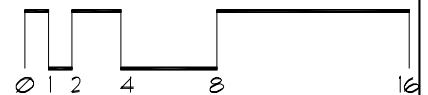

Roof Corrective Action

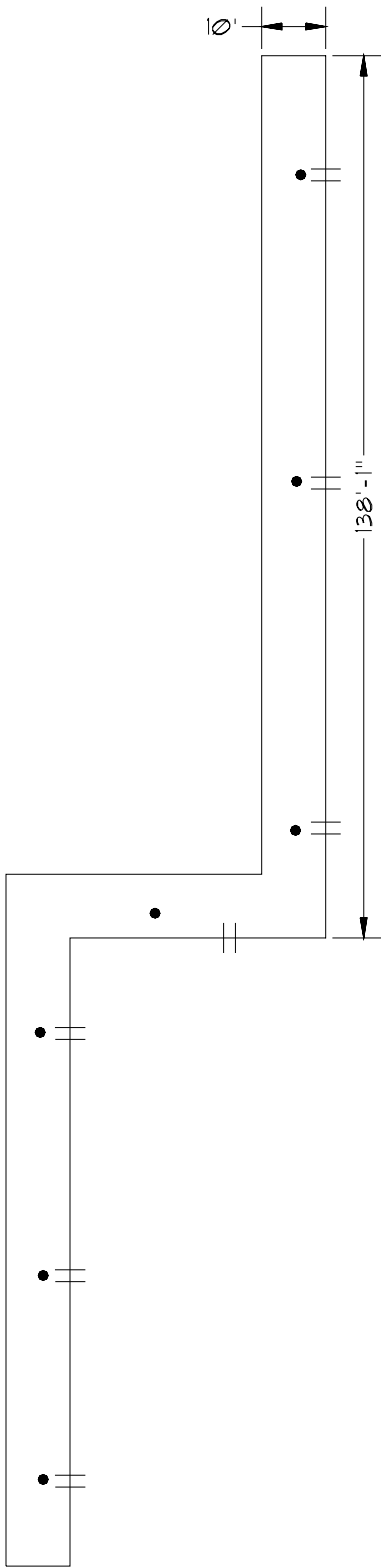

SYMBOLS KEY

- ROOF DRAIN
- || SCUPPER

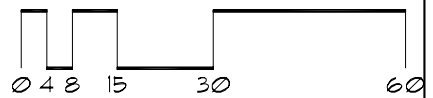
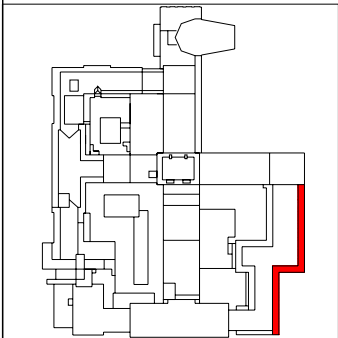

Roof Corrective Action

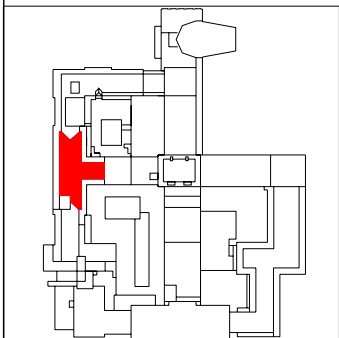
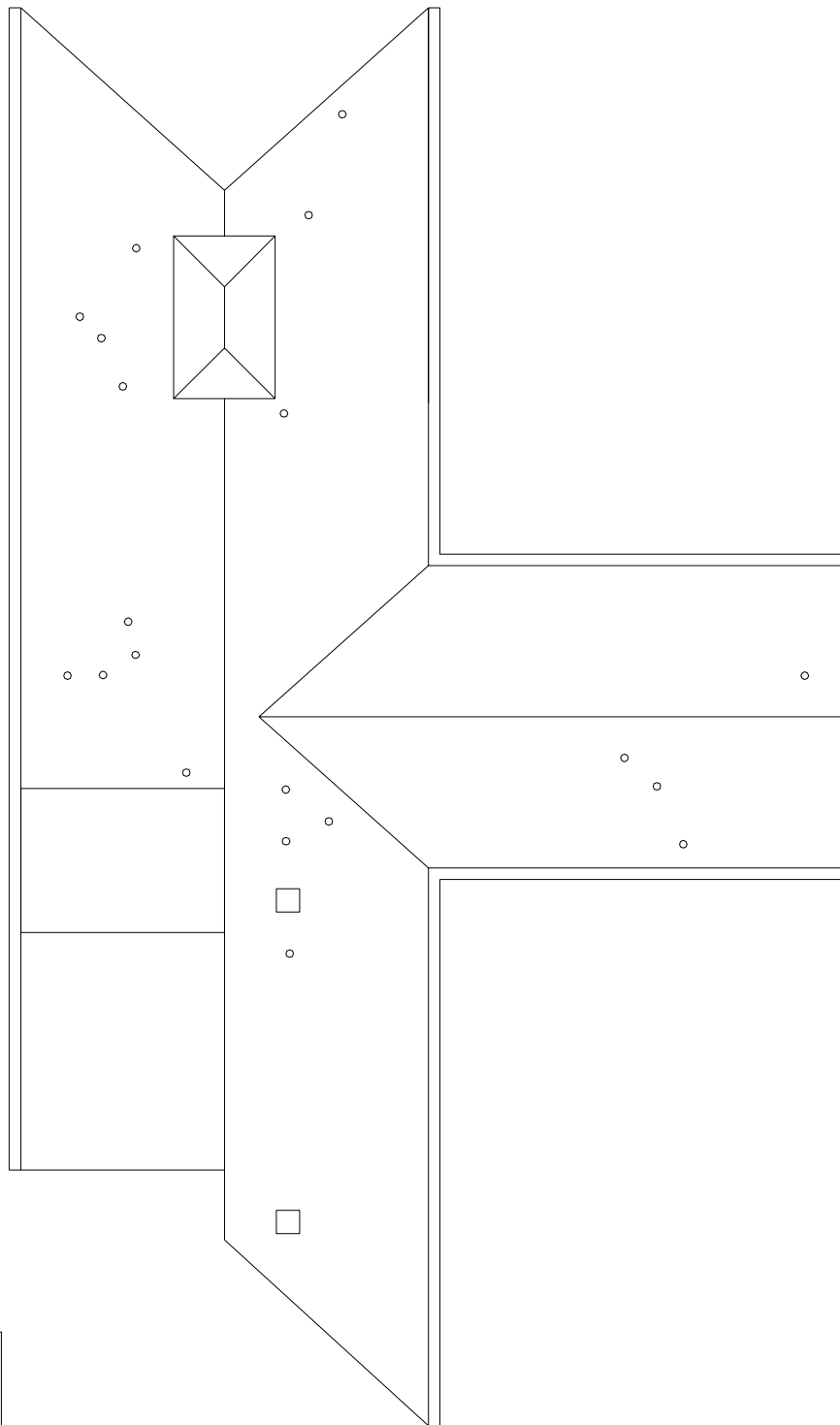

SYMBOLS KEY
□ ROOF CURB
○ VENT STACK



Roof Corrective Action

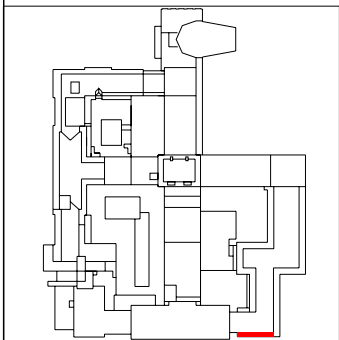
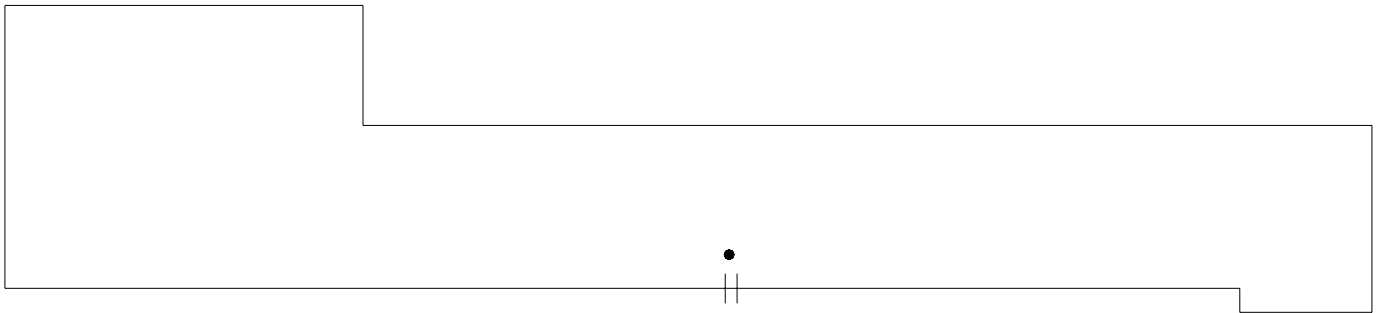

SYMBOLS KEY

- ROOF DRAIN
- †† SCUPPER

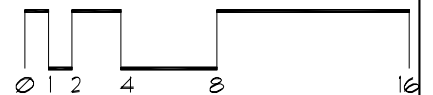

Roof Corrective Action

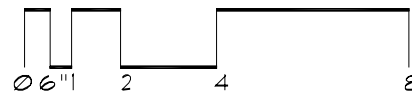
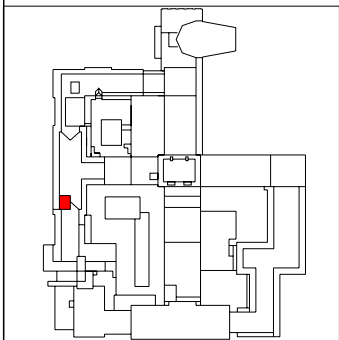
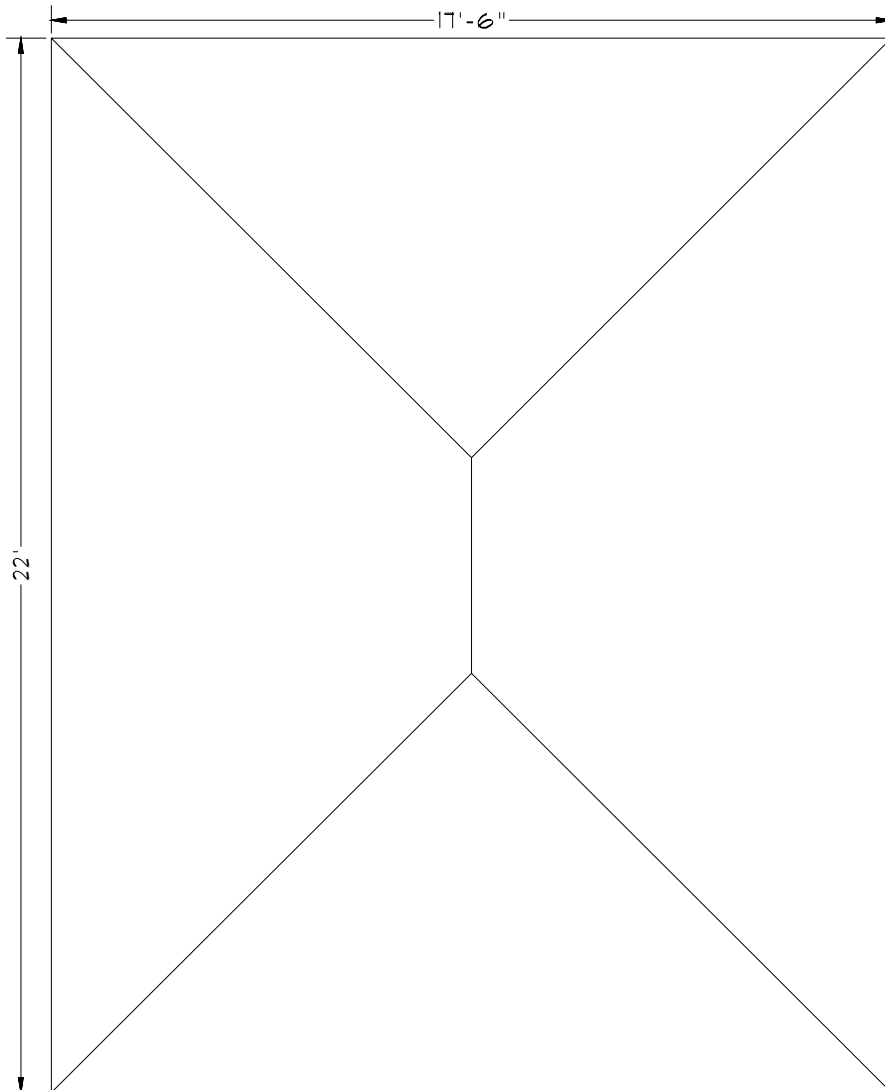

Roof Corrective Action

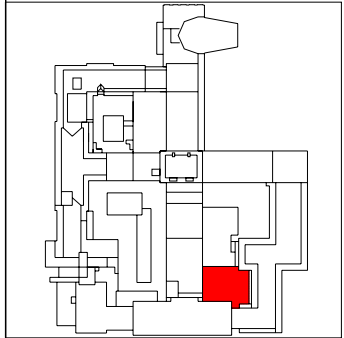
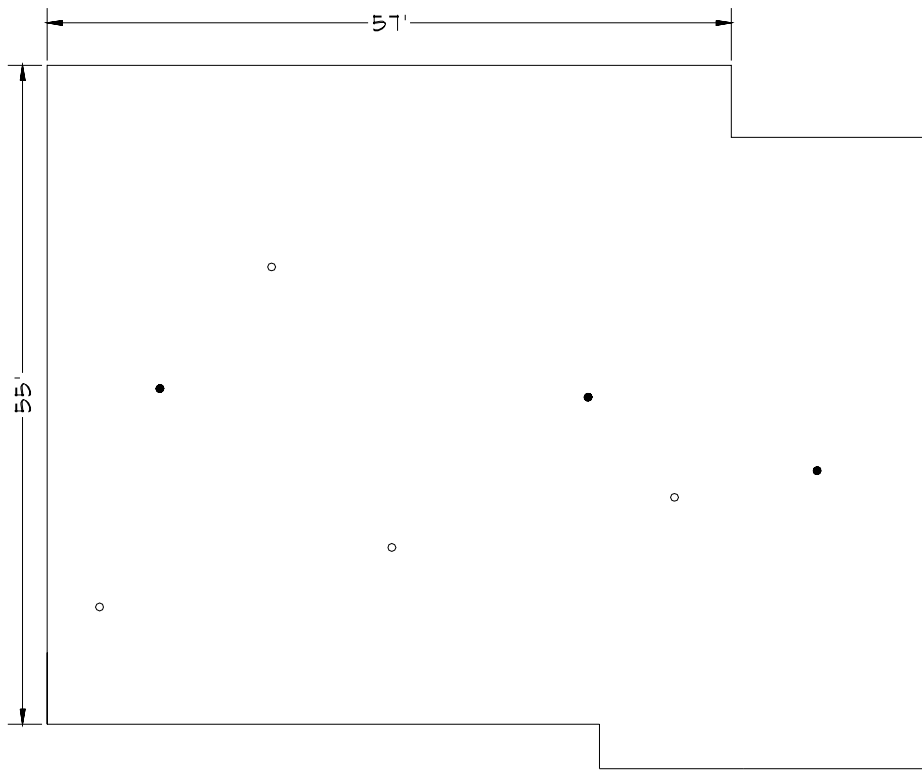

SYMBOLS KEY
● ROOF DRAIN
○ VENT STACK

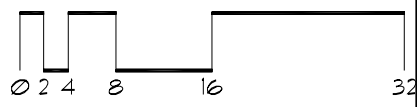
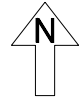

Roof ID

Building: HS107 - Masonic Hospital - (424 Harvard St SE)

Roof Access: Elevator to 5th floor, stairs through penthouse

Total Area: 17,564 sf

<u>A</u>	<u>390 sf</u>	<u>E</u>	<u>2,250 sf</u>	<u>I</u>	<u>1,240 sf</u>	<u>P</u>	<u>56 sf</u>
<u>B</u>	<u>5,162 sf</u>	<u>F</u>	<u>720 sf</u>	<u>J</u>	<u>350 sf</u>	<u>Q</u>	<u>96 sf</u>
<u>C</u>	<u>4,572 sf</u>	<u>G</u>	<u>96 sf</u>	<u>K</u>	<u>600 sf</u>		
<u>D</u>	<u>900 sf</u>	<u>H</u>	<u>840 sf</u>	<u>L</u>	<u>292 sf</u>		

SYMBOLS KEY

REPLACE IN 2012

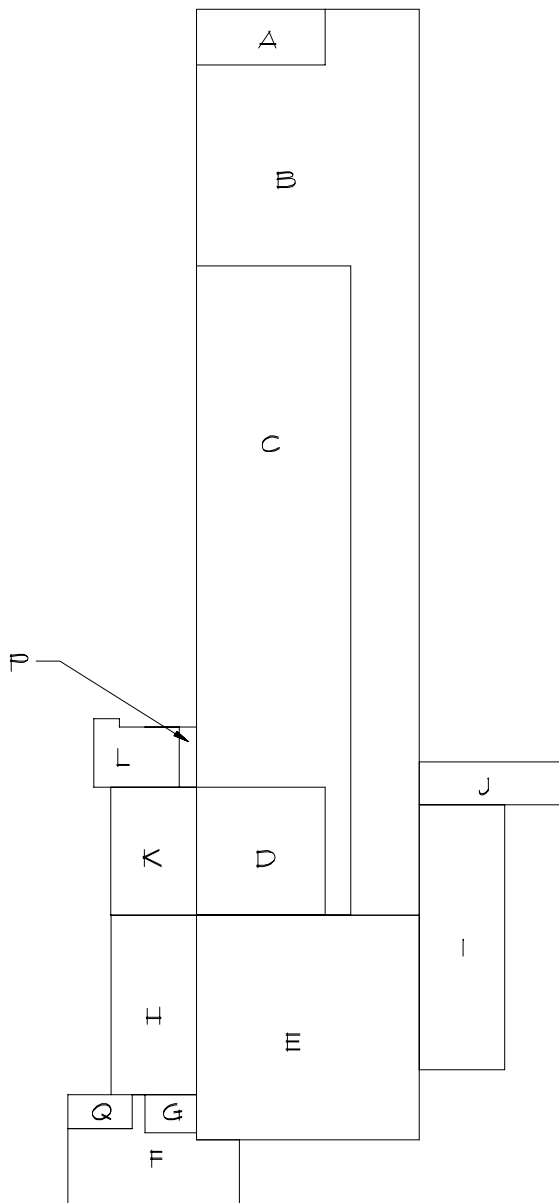

Roof Corrective Action

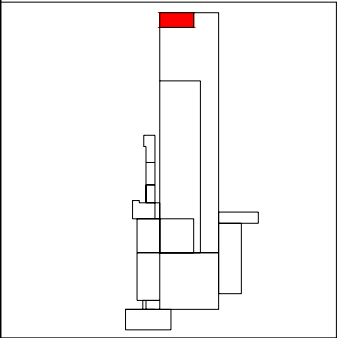
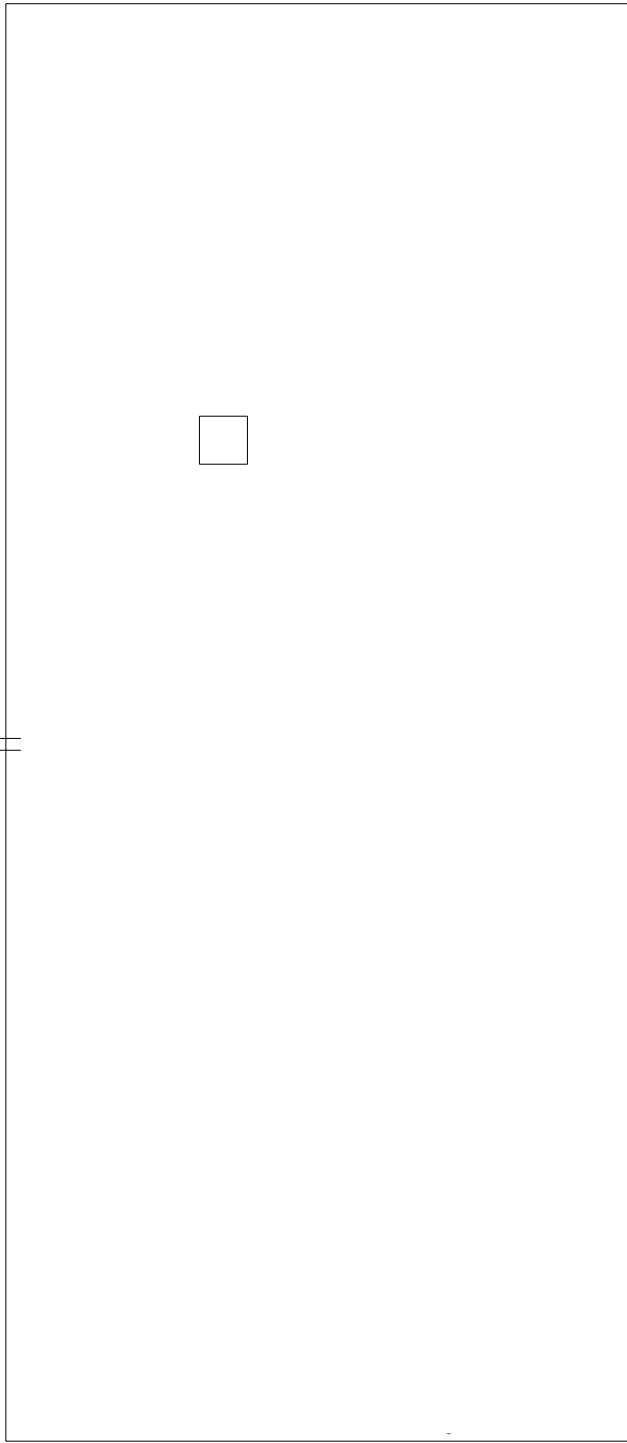

- SYMBOLS KEY
- † SCUPPER
 - ROOF CURB
 - ⓪ DEFECT-NO REPAIR

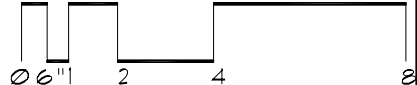

Roof Corrective Action

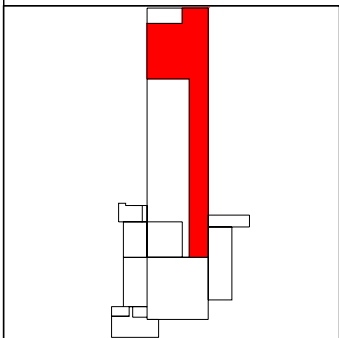
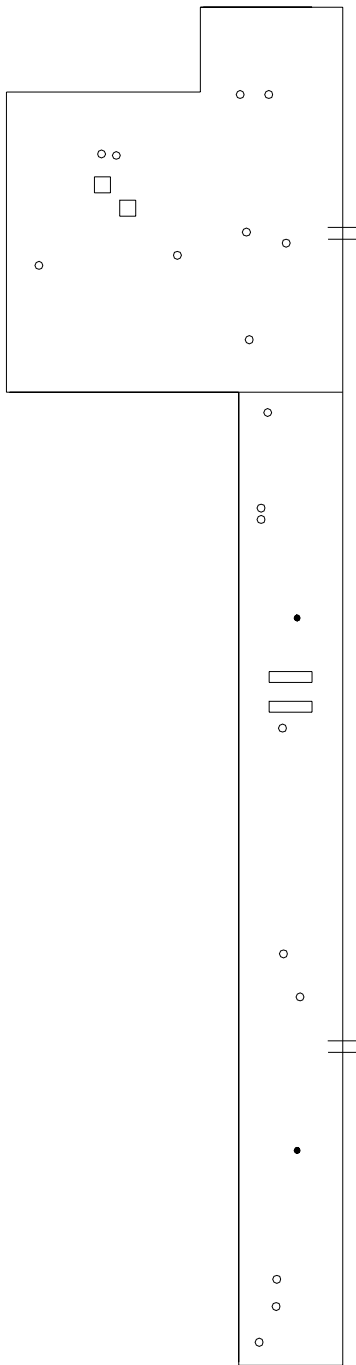

SYMBOLS KEY

- VENT STACK
- ROOF DRAIN
- ROOF CURB
- ① DEFECT-REPAIR

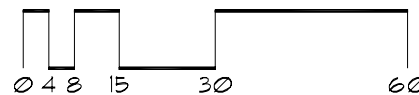

Roof Corrective Action

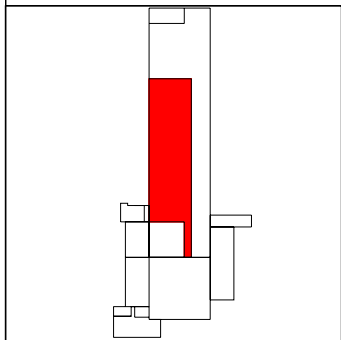
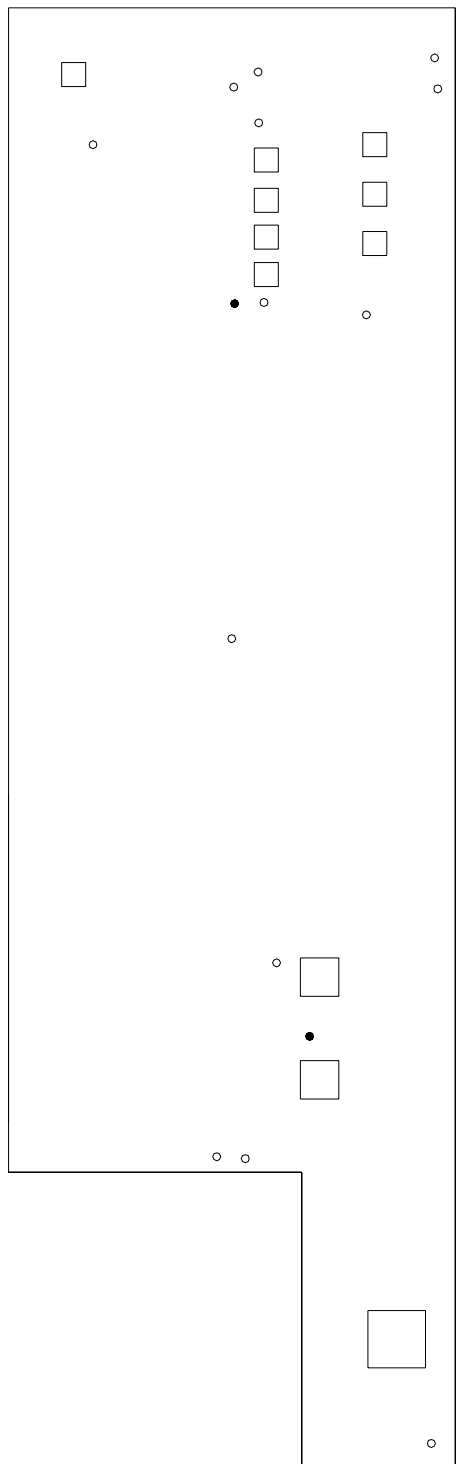

- SYMBOLS KEY**
- VENT STACK
 - ROOF DRAIN
 - ROOF CURB

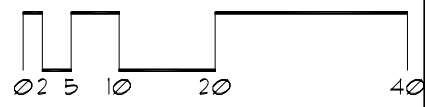

Roof Corrective Action

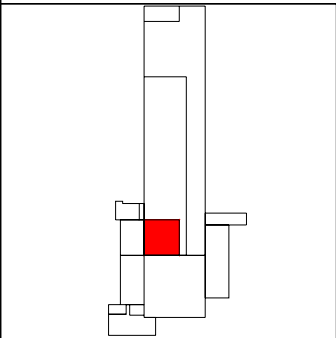
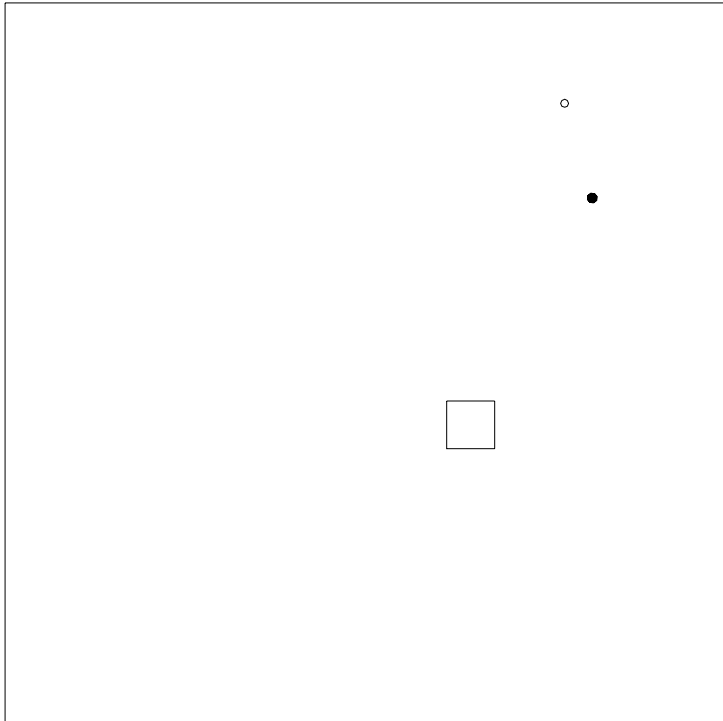

SYMBOLS KEY
○ VENT STACK
□ ROOF CURB

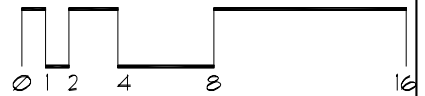

Roof Corrective Action

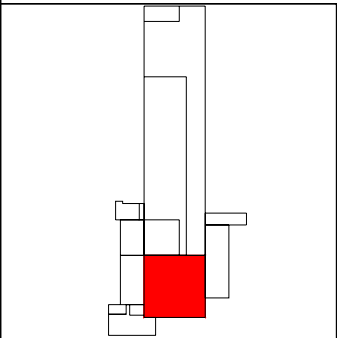
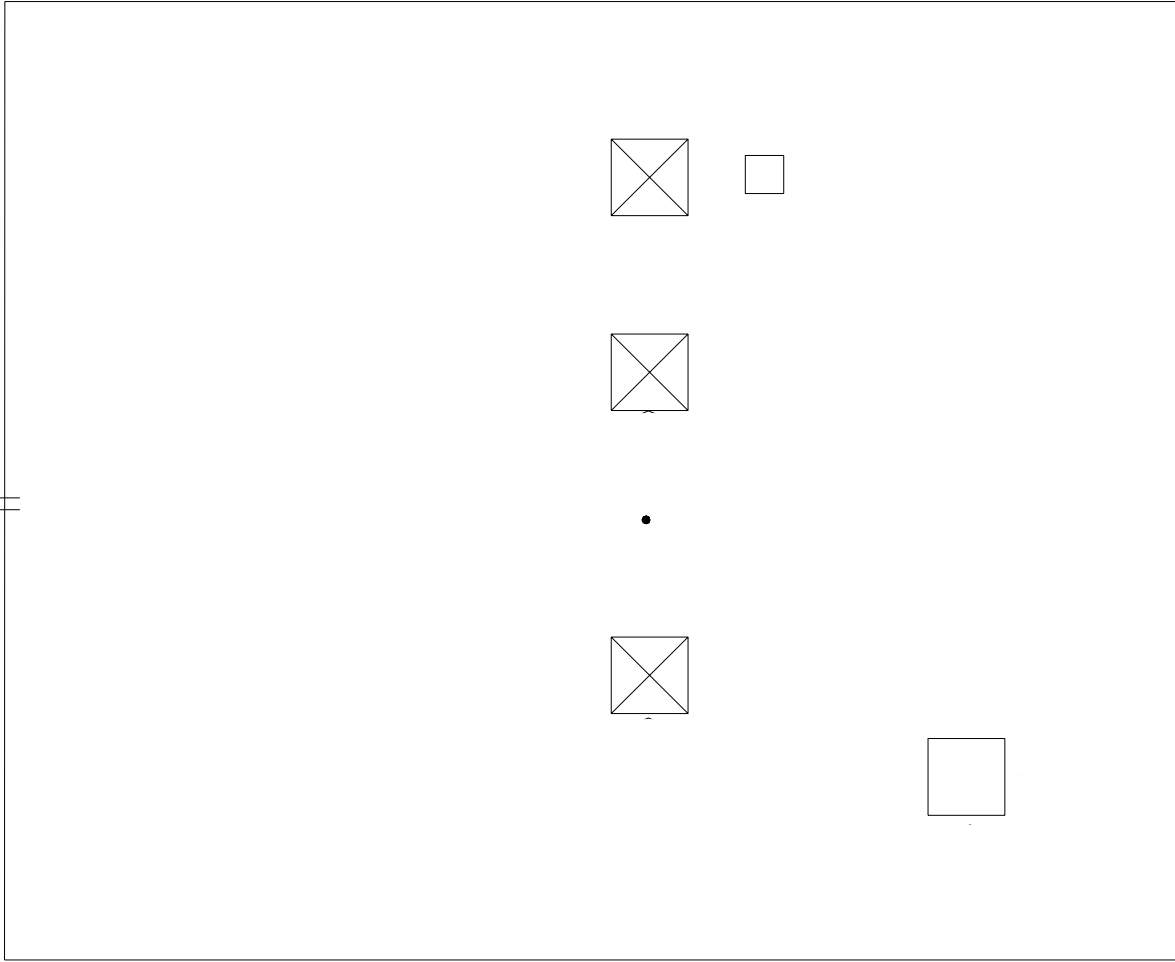

- SYMBOLS KEY**
- ROOF DRAIN
 - ROOF CURB
 - ⊠ SKYLIGHT
 - ⓪ DEFECT-NO REPAIR
 - Ⓢ DEFECT-REPAIR

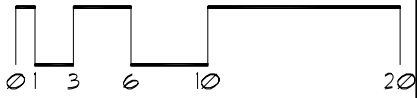

Roof Corrective Action

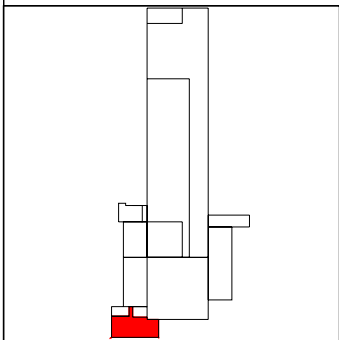
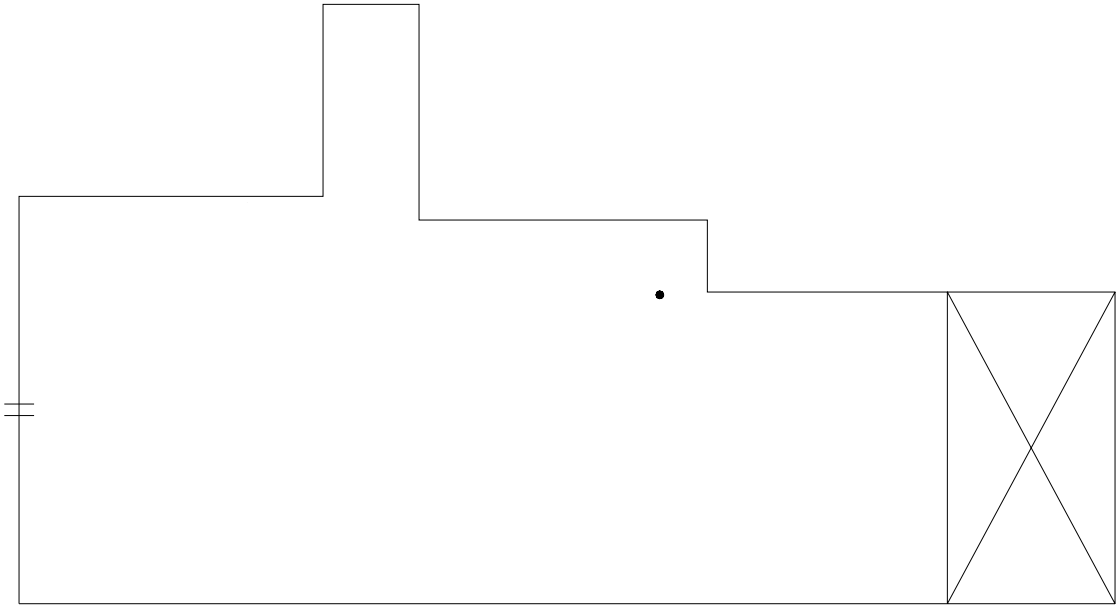

SYMBOLS KEY
|| SCUPPER
● ROOF DRAIN

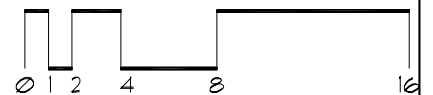

Roof Corrective Action

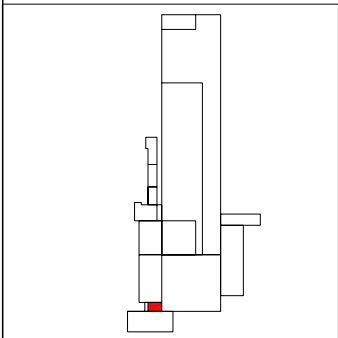

SYMBOLS KEY
① DEFECT-NO REPAIR
Ⓢ DEFECT-REPAIR

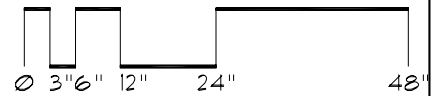

Roof Corrective Action

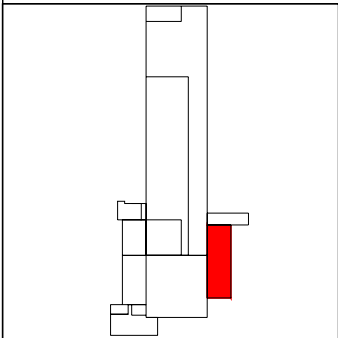
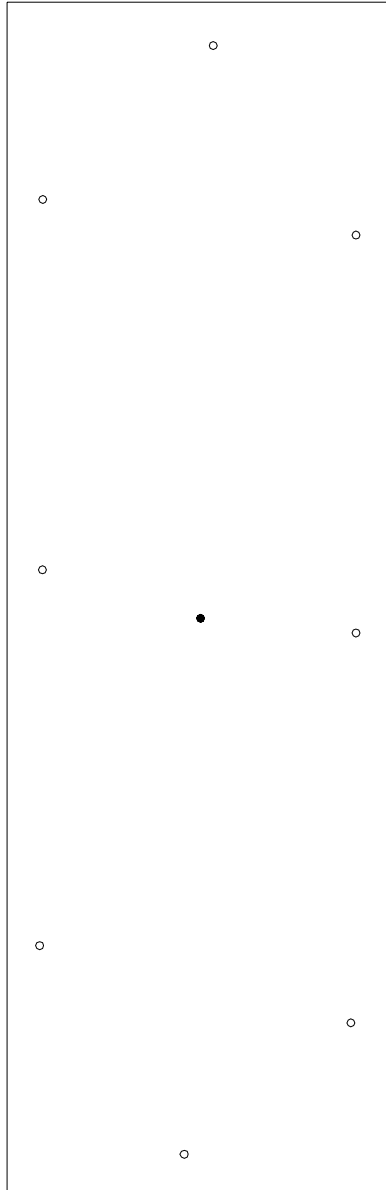

SYMBOLS KEY
○ VENT STACK
● ROOF DRAIN

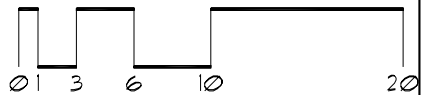

Roof Corrective Action

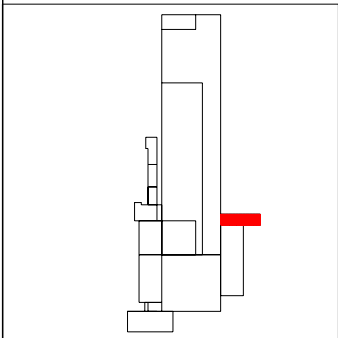
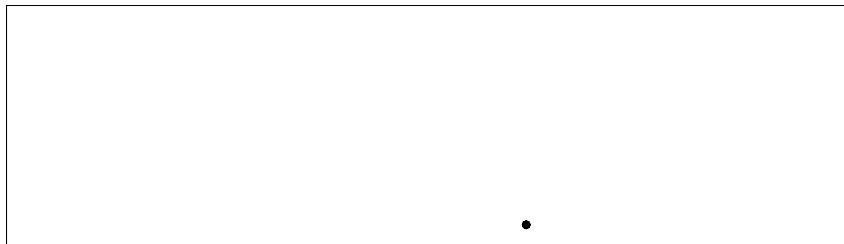

SYMBOLS KEY
• ROOF DRAIN

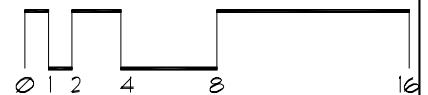

Roof Corrective Action

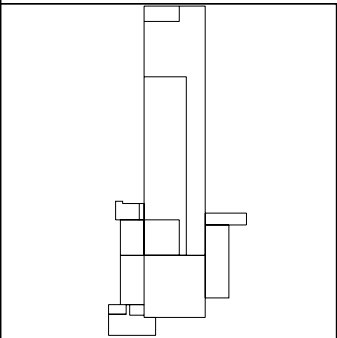
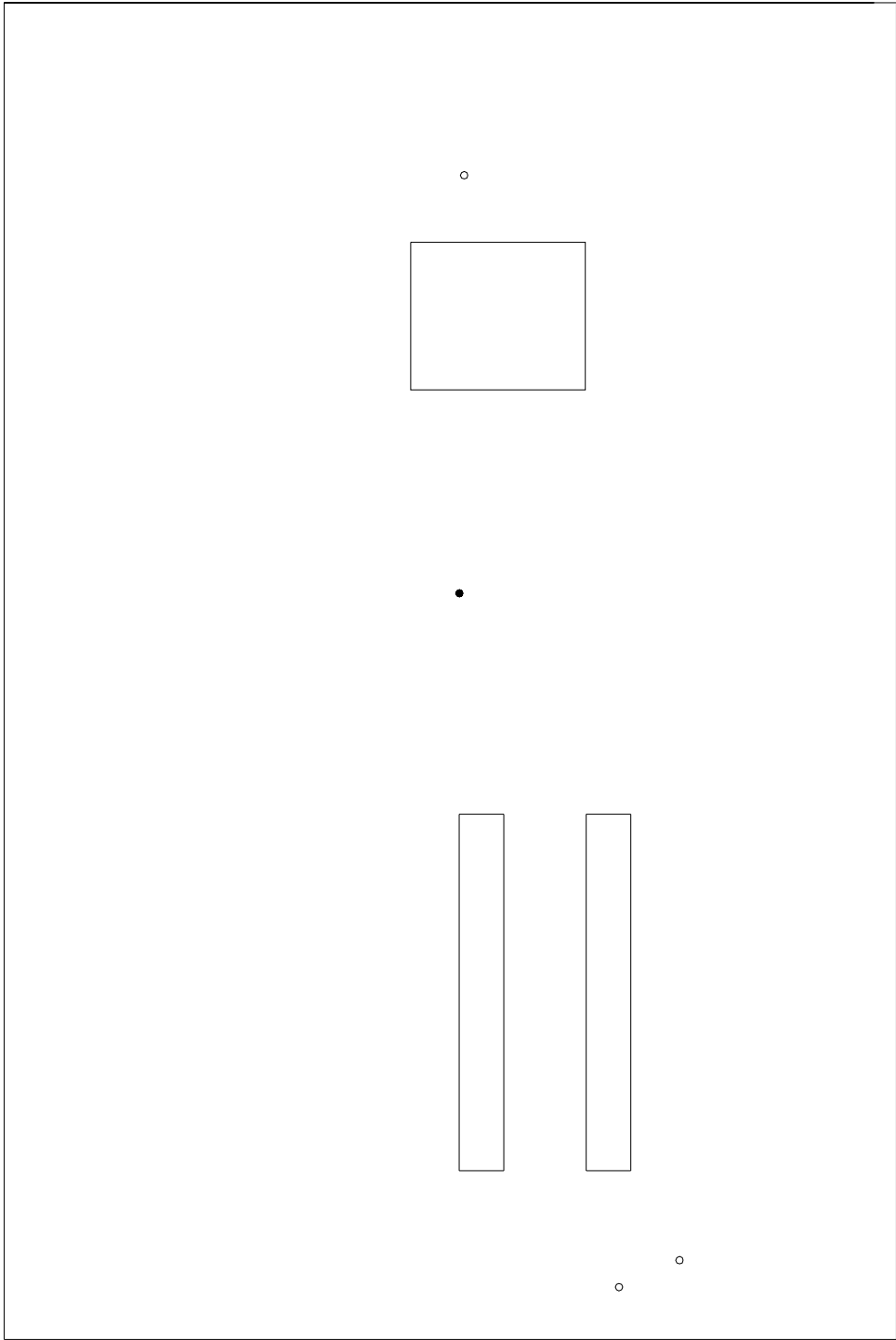

- SYMBOLS KEY**
- VENT STACK
 - ROOF DRAIN
 - ROOF CURB
 - ≡ SLEEPER CURB

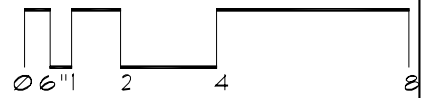

Roof Corrective Action

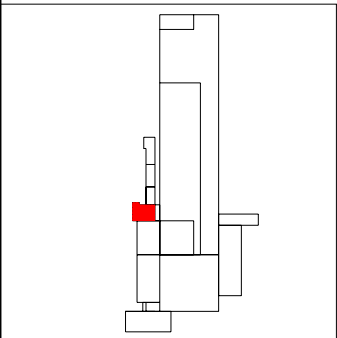
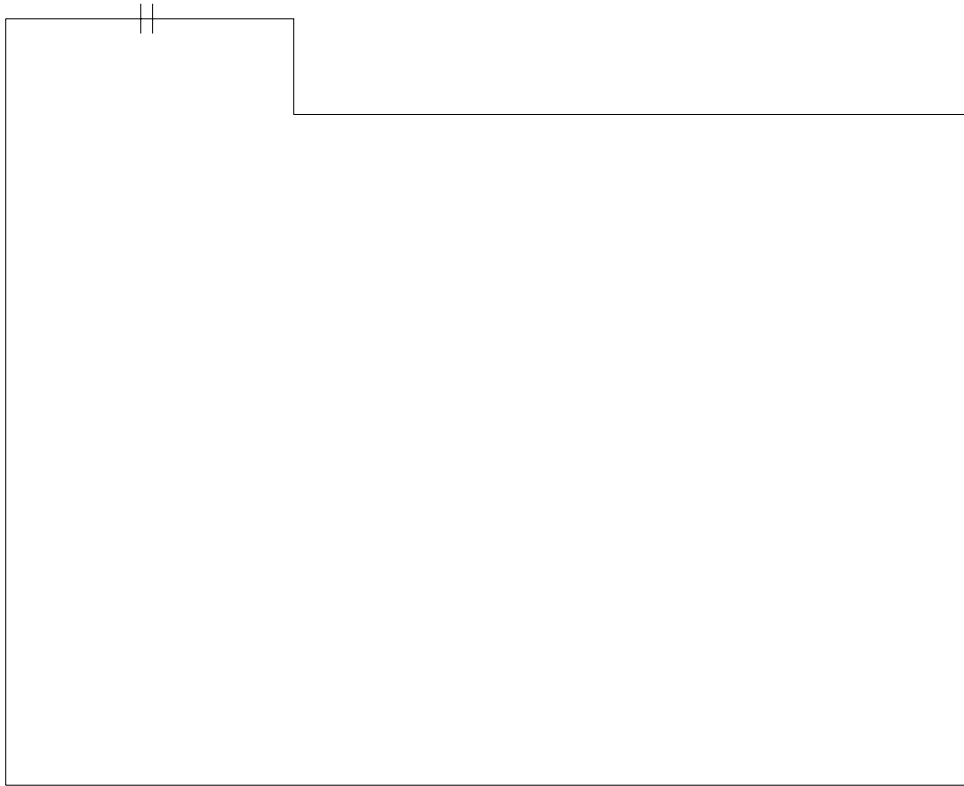

SYMBOLS KEY
|| SCUPPER

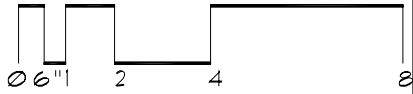

Roof Corrective Action

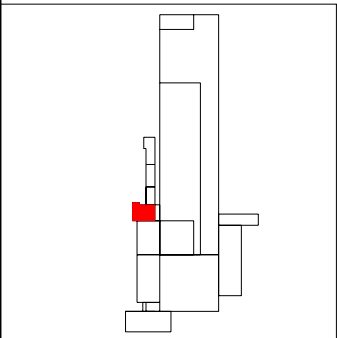
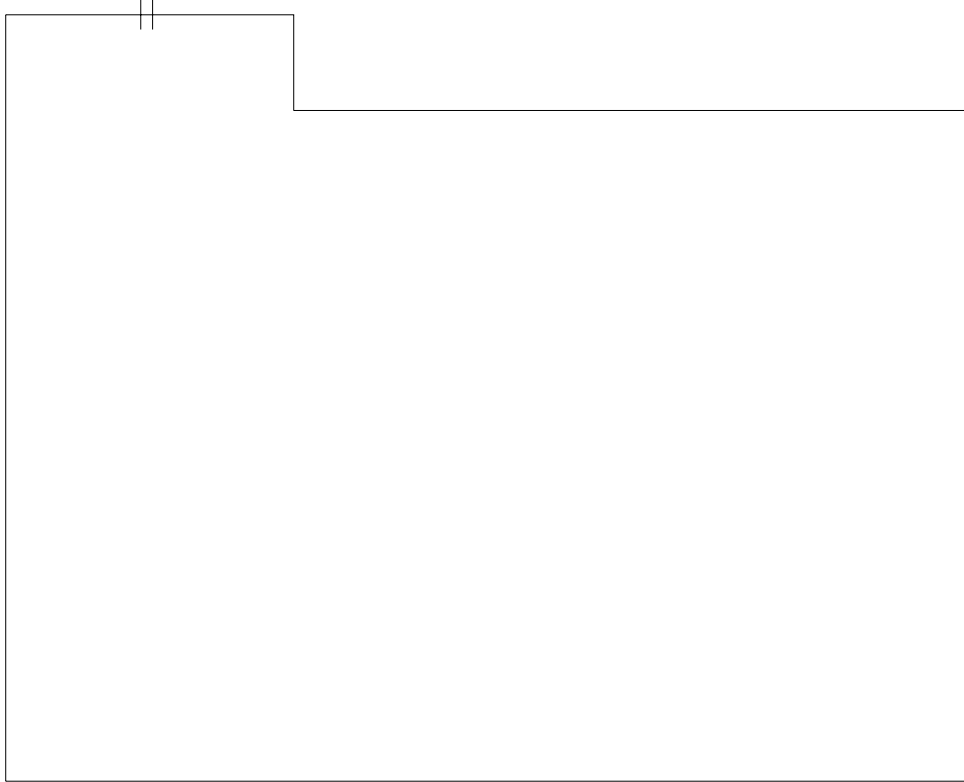

SYMBOLS KEY
|| SCUPPER

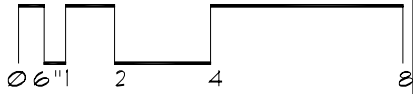

Roof Corrective Action

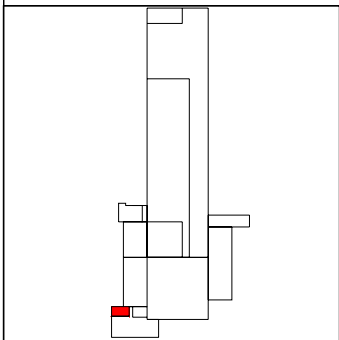
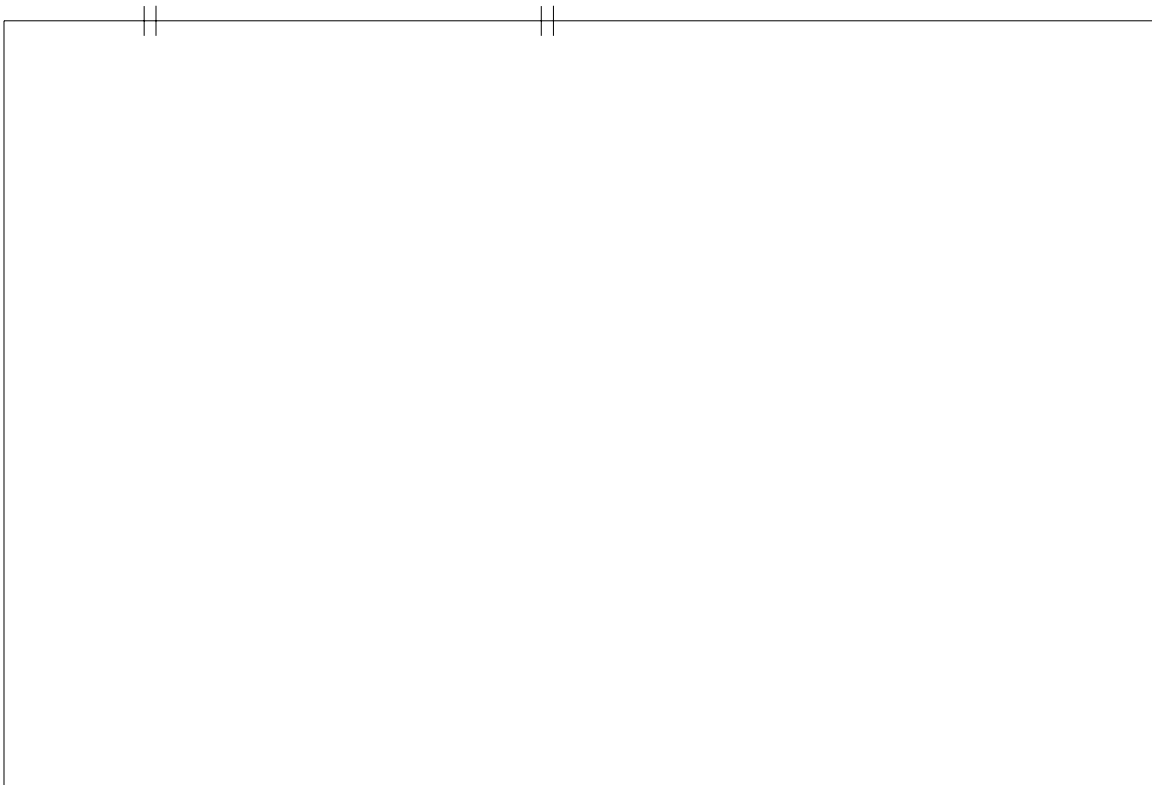

SYMBOLS KEY
|| SCUPPER

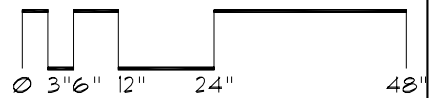

Roof Corrective Action

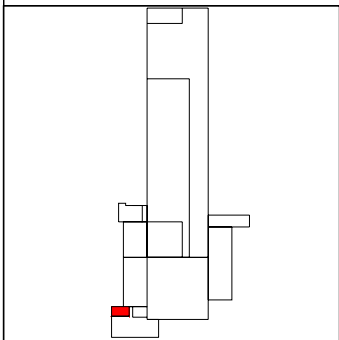
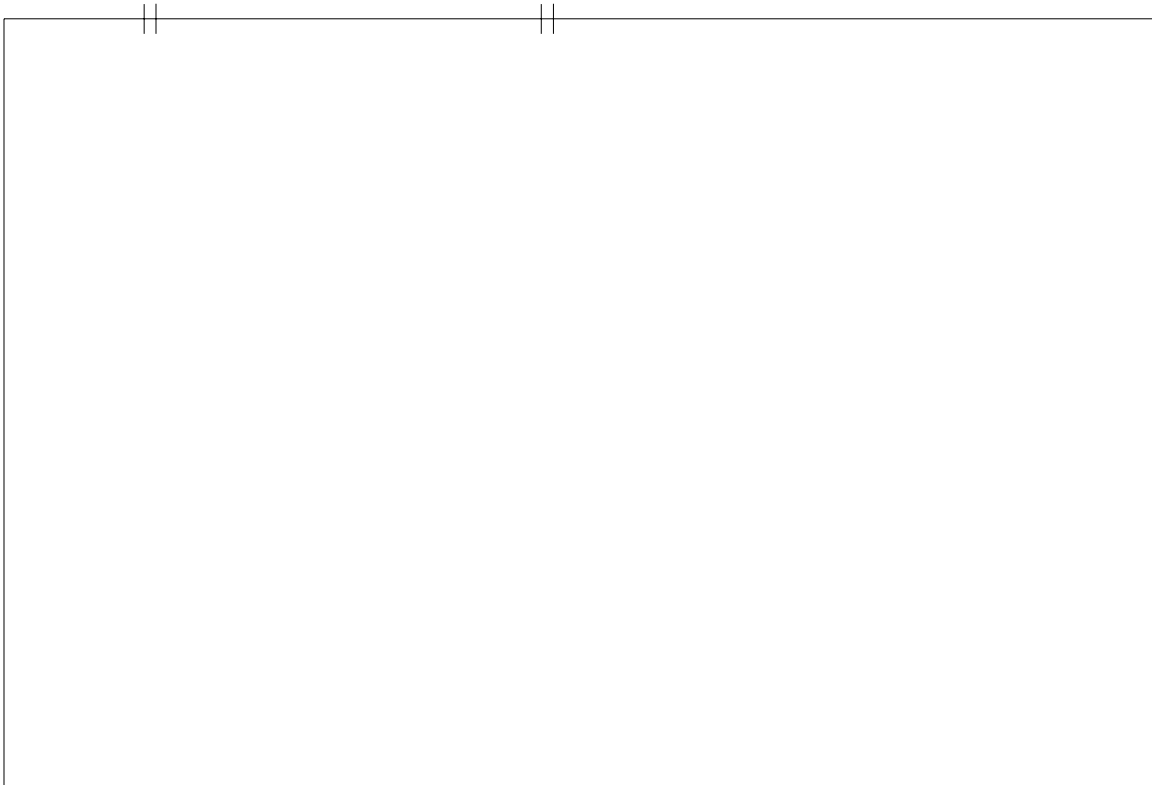

SYMBOLS KEY
|| SCUPPER

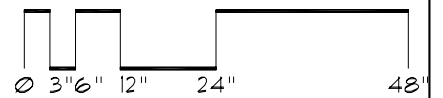

Roof ID

Building: HS108 - Diehl Hall - (505 Essex Street SE Minneapolis)

Roof Access: Front entrance-elevator to 6th floor-mech room, door at sw corner

Total Area: 14,130 sf

A 14,130 sf



A

Roof Corrective Action

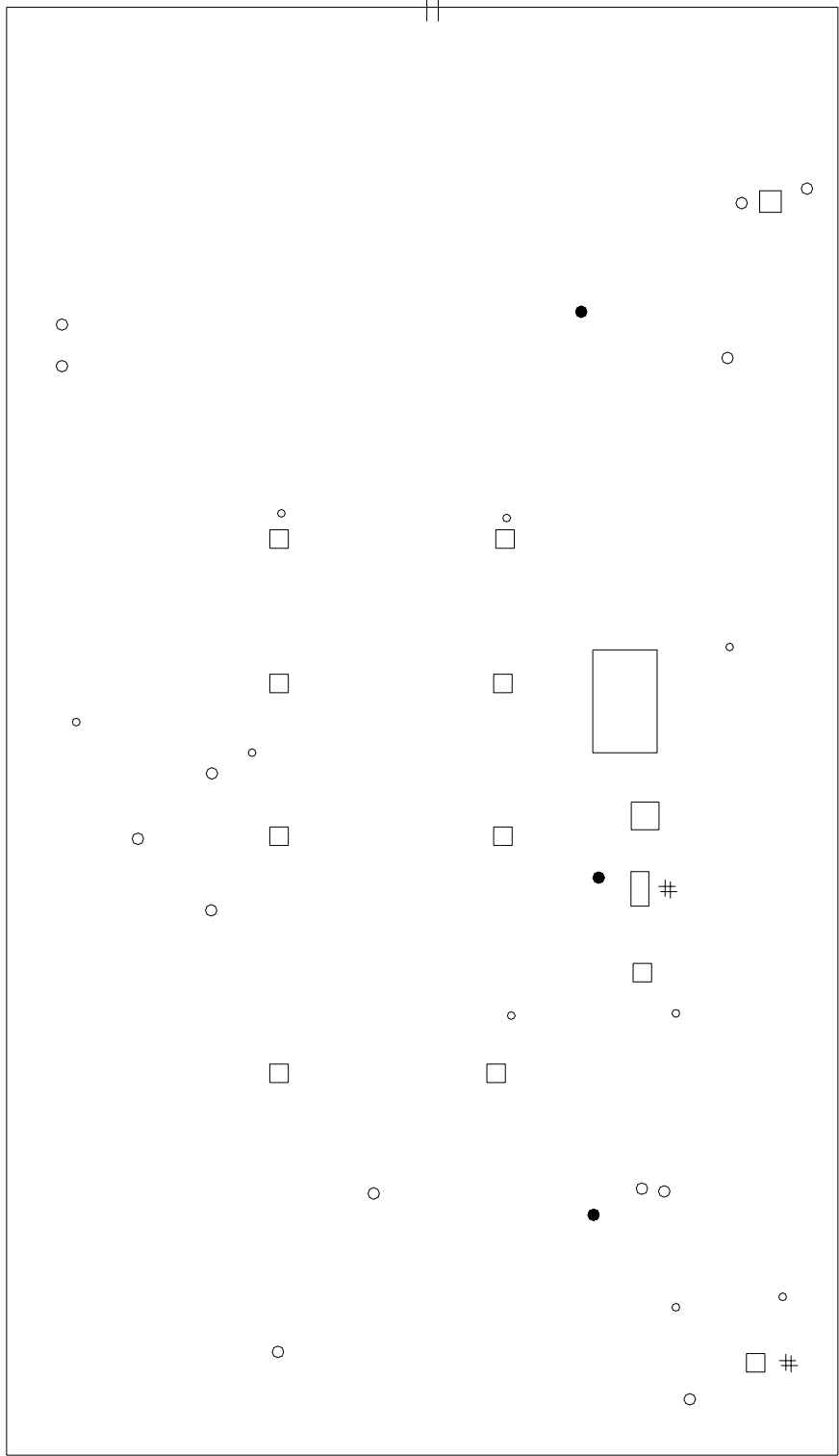

SYMBOLS KEY

- VENT STACK
- ROOF DRAIN
- ROOF CURB
- ⊞ PITCH PAN
- ⓪ DEFECT-NO REPAIR

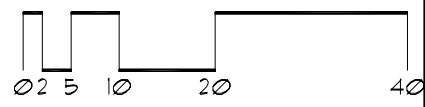

Roof ID

Building: HS109 - VFW Cancer Research - (406 Harvard St SE)

Roof Access: Stairs to penthouse to roof access

Total Area: 5,200 sf

A 1,700 sf

B 3,060 sf

C 300 sf

D 140 sf

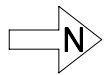
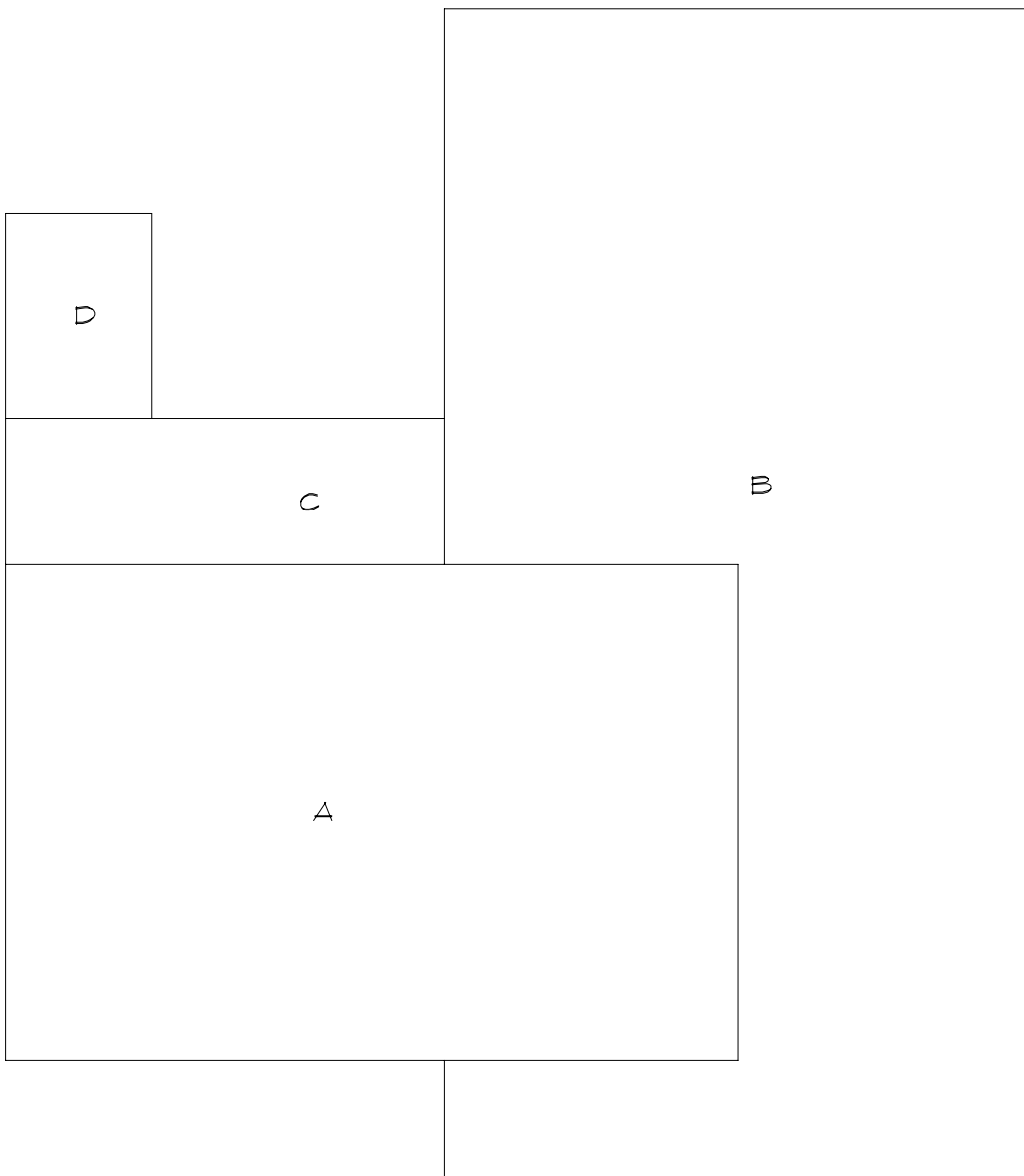

Roof Corrective Action

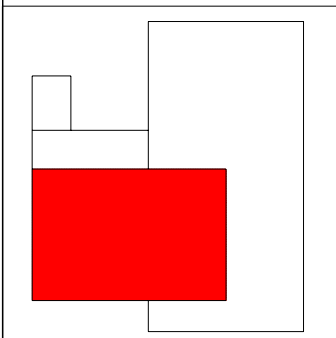
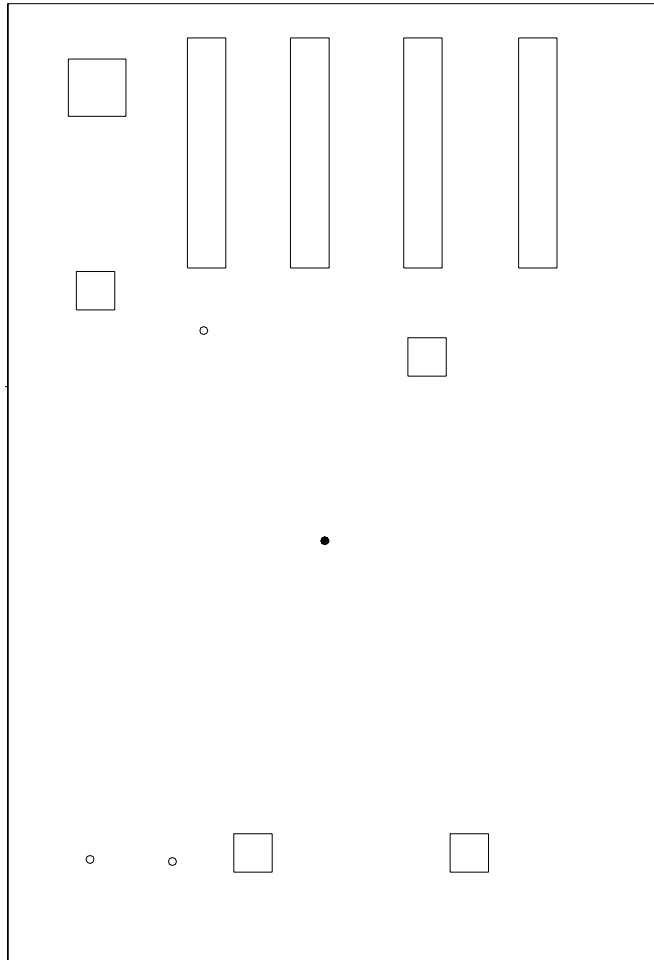

SYMBOLS KEY

- VENT STACK
- ROOF DRAIN
- ROOF CURB
- ▤ SLEEPER CURB
- ① DEFECT-NO REPAIR

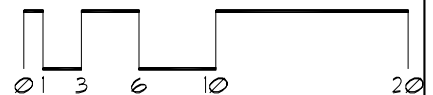

Roof Corrective Action

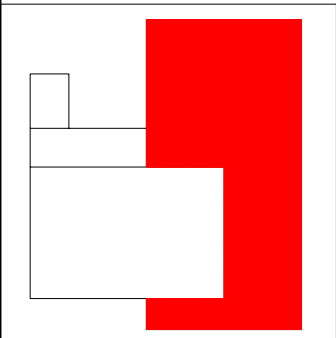
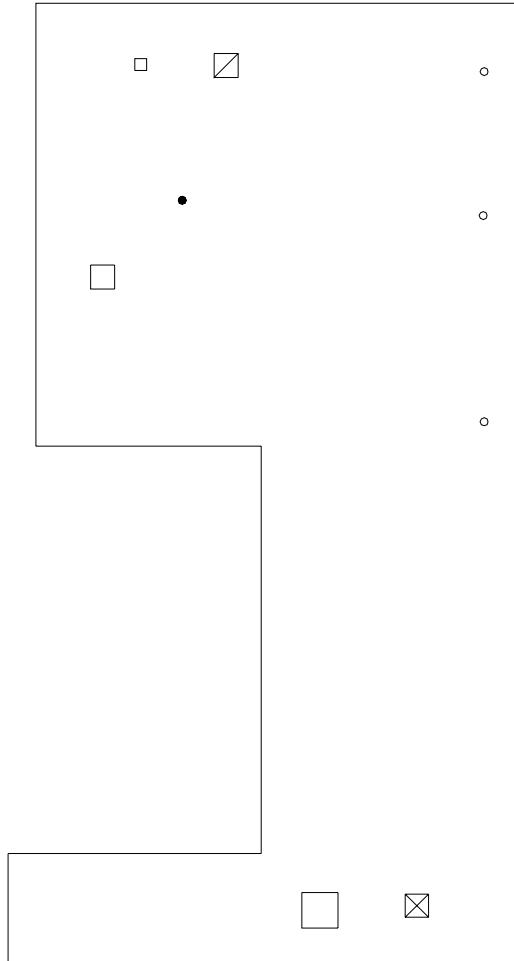

SYMBOLS KEY

- VENT STACK
- ROOF DRAIN
- ROOF CURB
- ⊗ SKYLIGHT
- ▣ ROOF HATCH

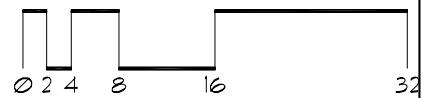
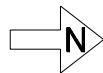

Roof Corrective Action

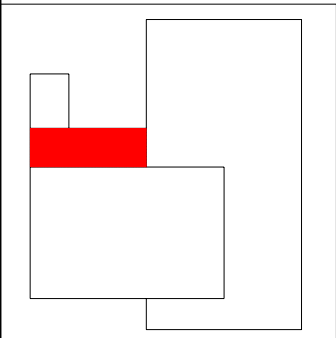
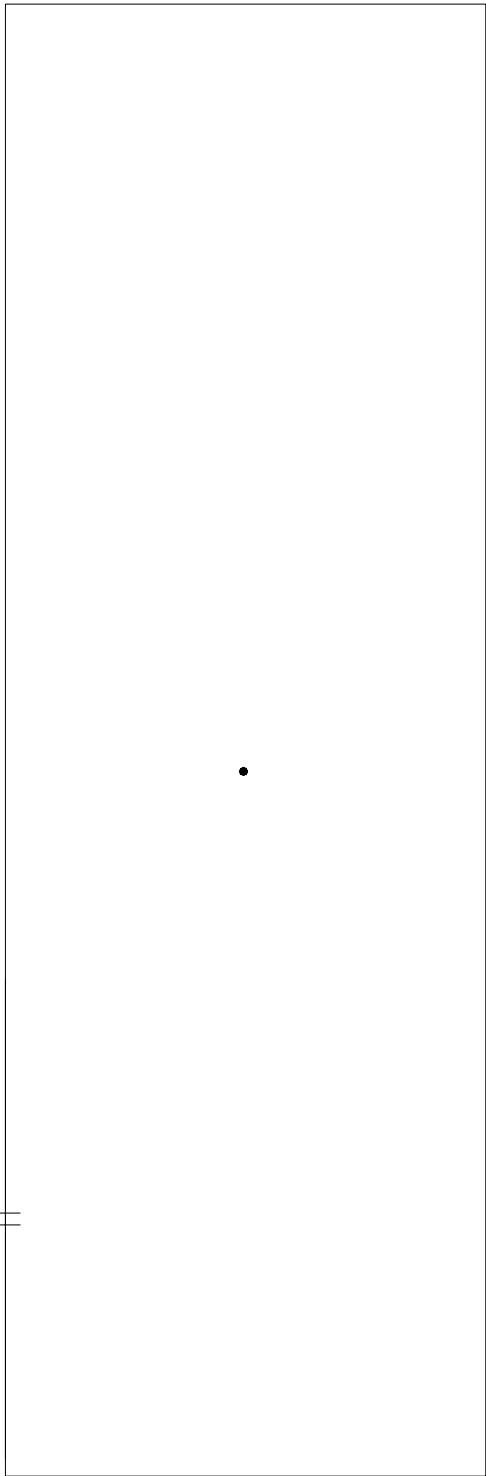

SYMBOLS KEY

- ROOF DRAIN
- ≡ SCUPPER

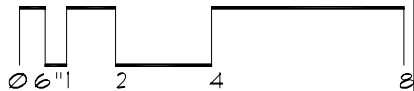

Roof Corrective Action

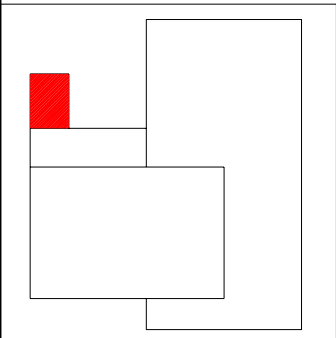
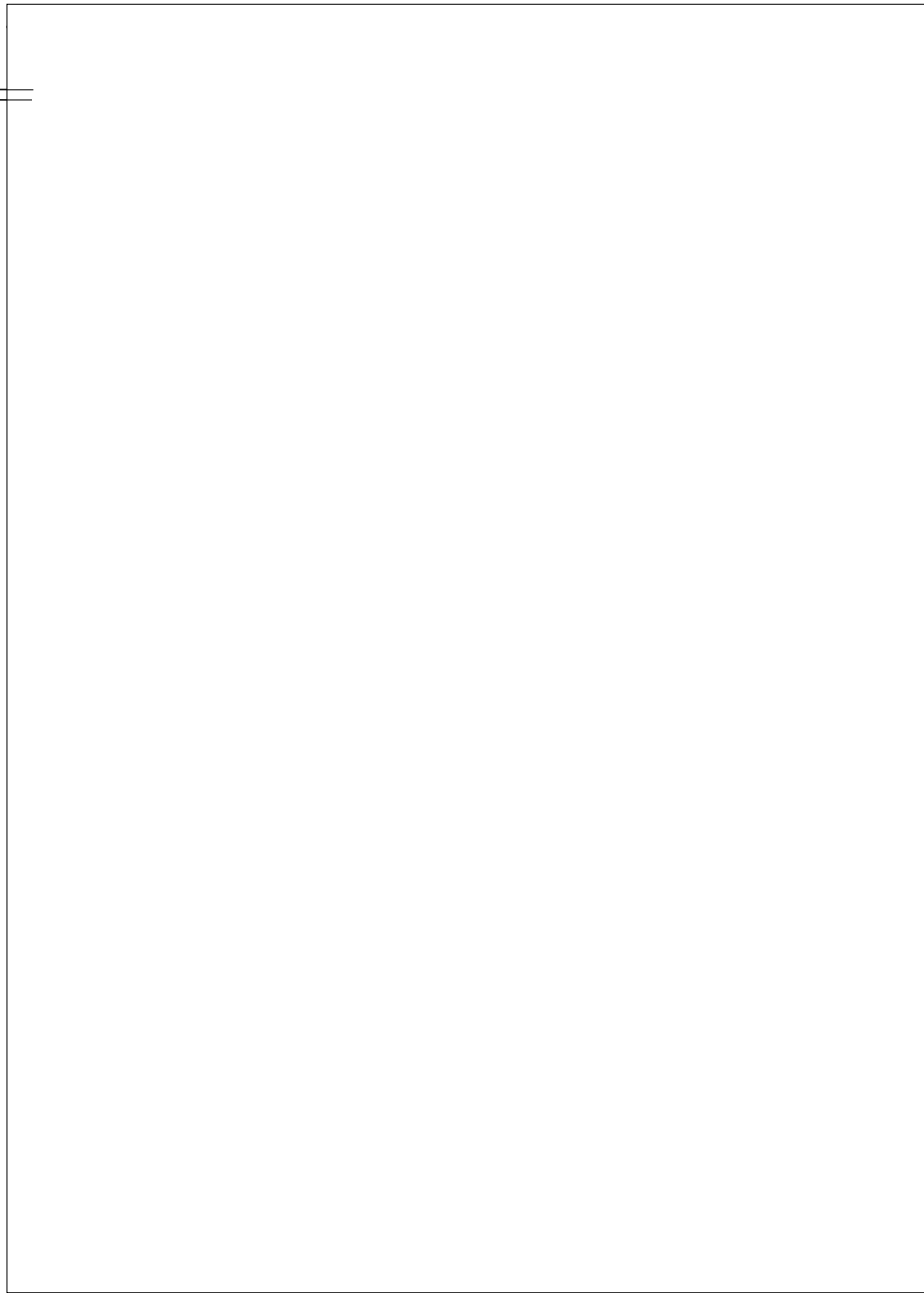

SYMBOLS KEY
|| SCUPPER
⓪ DEFECT-NO REPAIR

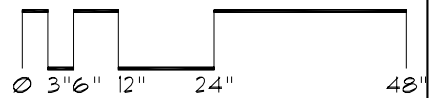

Roof ID

Building: HS111 - Diehl Hall Lab - (505 Essex St SE)

Roof Access: From Diehl Hall: front entrance-elevator to 6th floor-mech room, door at sw corner-ladder to roof

Total Area: 7,940 sf

A 7,440 sf

B 300 sf

C 200 sf

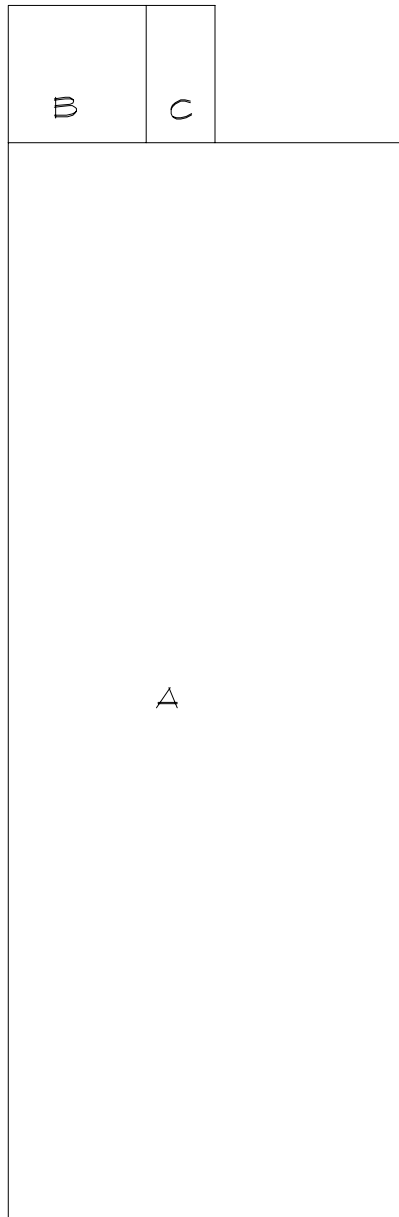

Roof Corrective Action

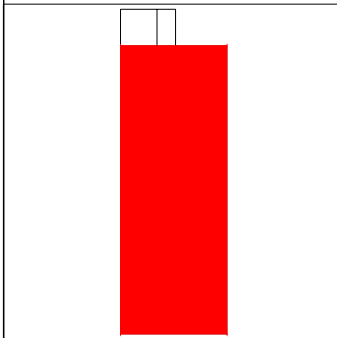
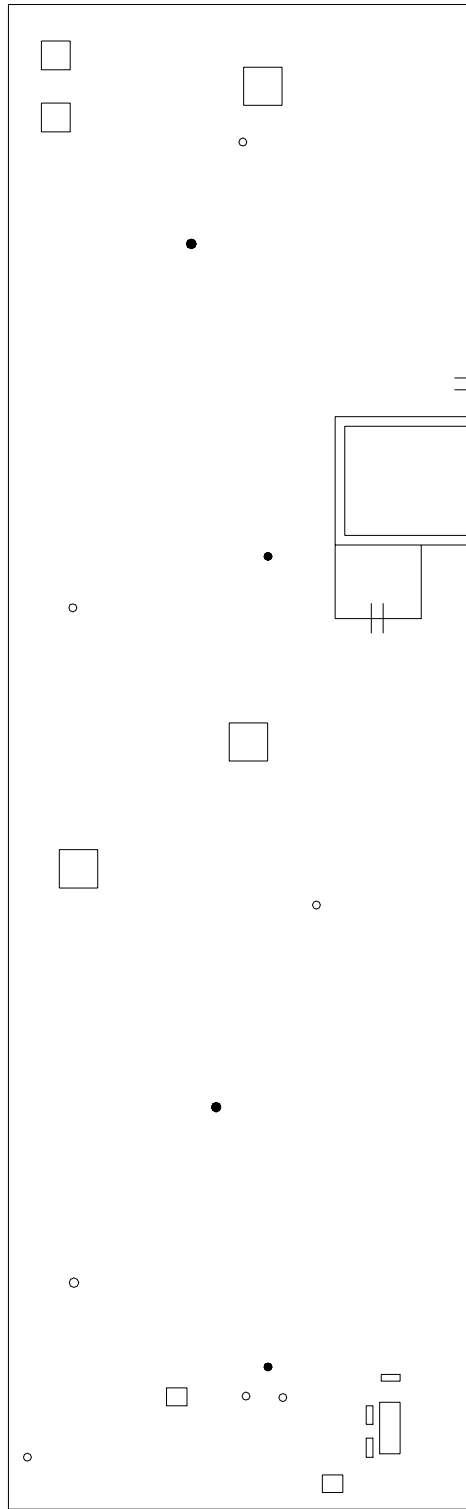

SYMBOLS KEY

- VENT STACK
- ROOF DRAIN
- ROOF CURB
- Ⓜ DEFECT-REPAIR

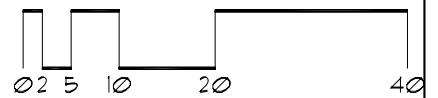

Roof Corrective Action

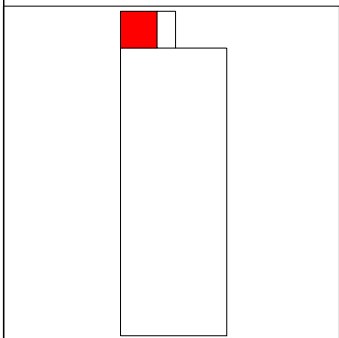
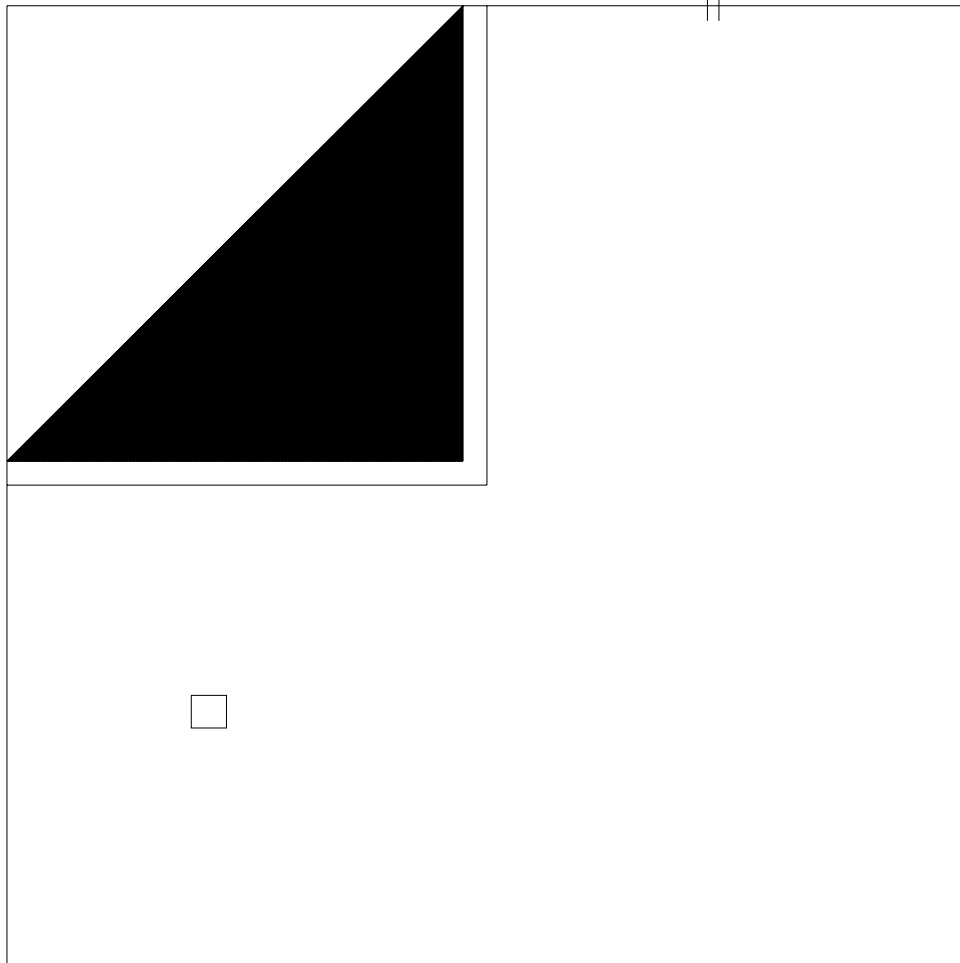

SYMBOLS KEY

- ROOF CURB
- ++ SCUPPER
- CHIMNEY

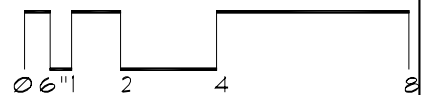

Roof Corrective Action

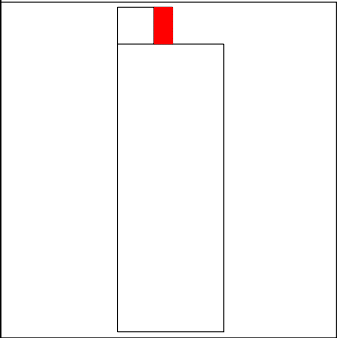

SYMBOLS KEY
|† SCUPPER

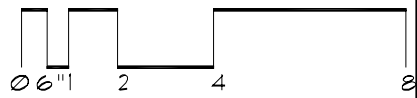
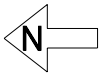

Roof ID

Building: HS115 - Children's Rehabilitation Center - (426 Church St. SE)

Total Area: 12,569 sf

A	4,047 sf	E	3,122 sf	I	515 sf
B	961 sf	F	823 sf		
C	1,116 sf	G	310 sf		
D	989 sf	H	686 sf		

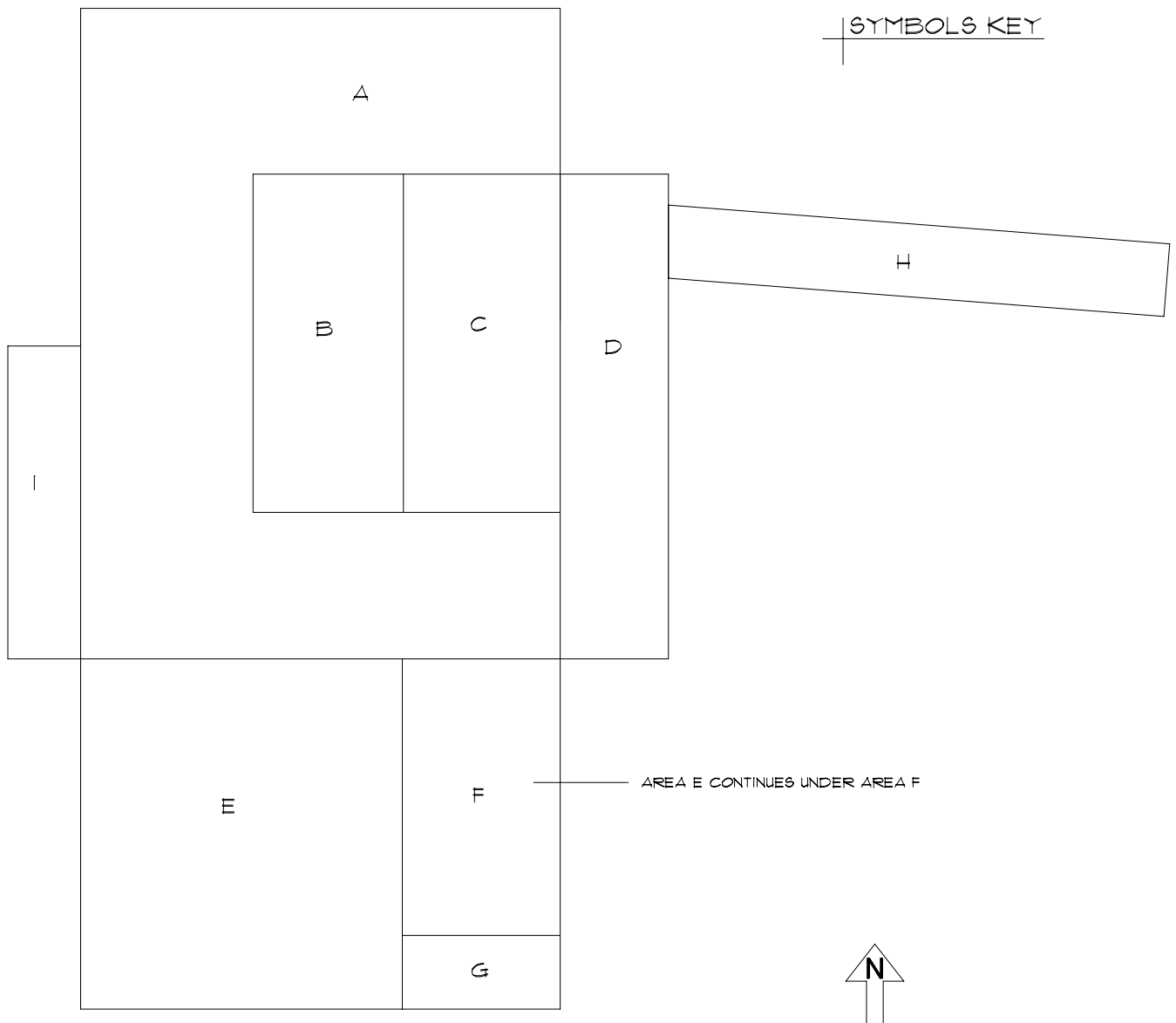

Roof Corrective Action

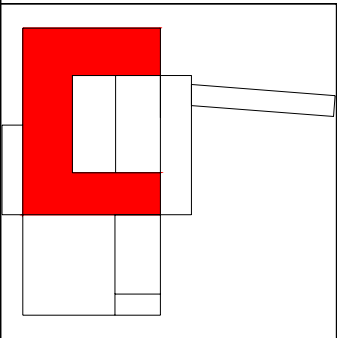
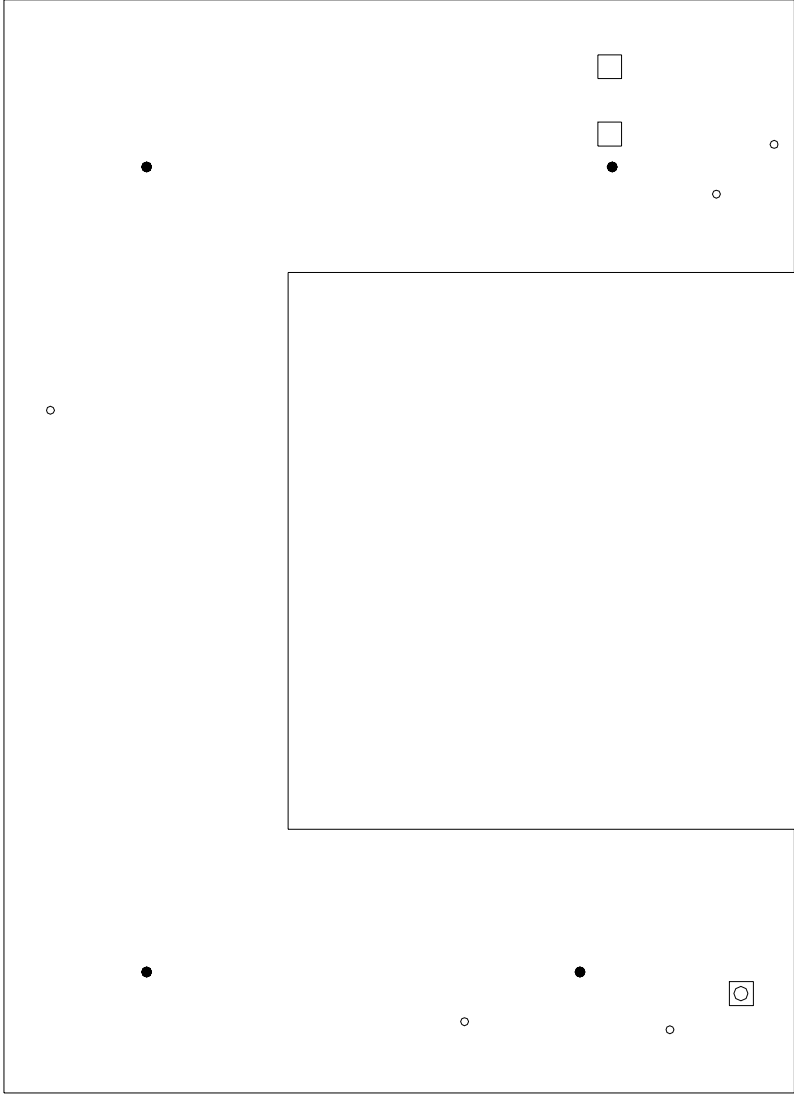

- SYMBOLS KEY**
- ROOF CURB
 - ROOF DRAIN
 - VENT STACK
 - ⊠ BOILER STACK

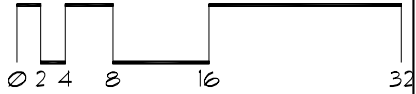

Roof Corrective Action

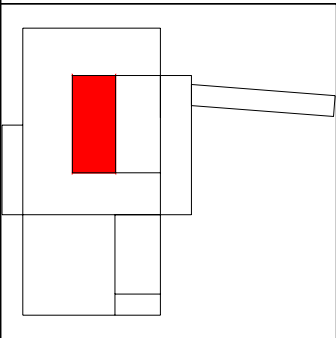
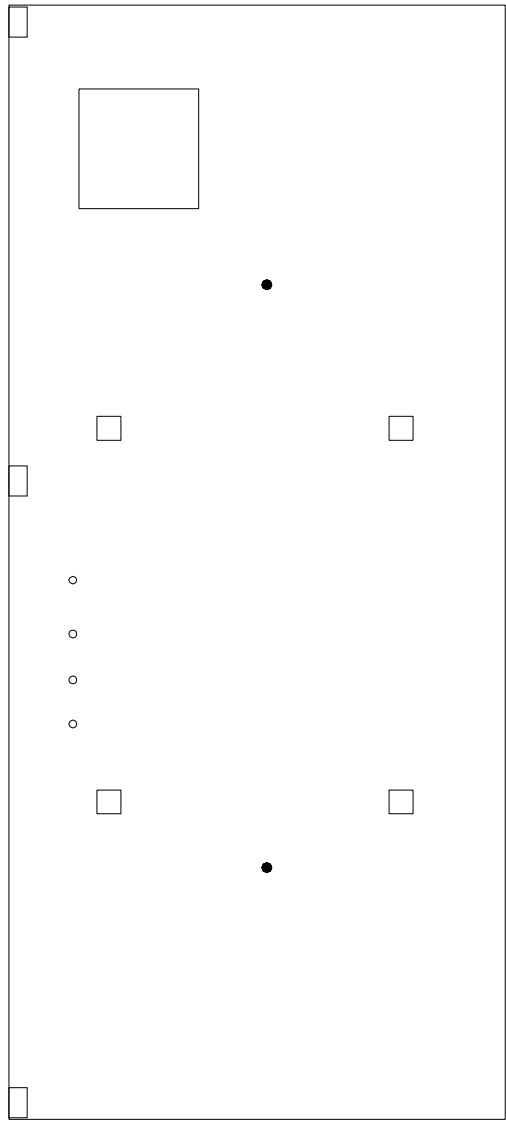

- SYMBOLS KEY**
- ROOF CURB
 - ROOF DRAIN
 - VENT STACK

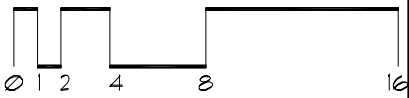

Roof Corrective Action

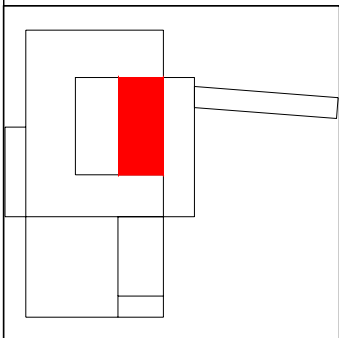
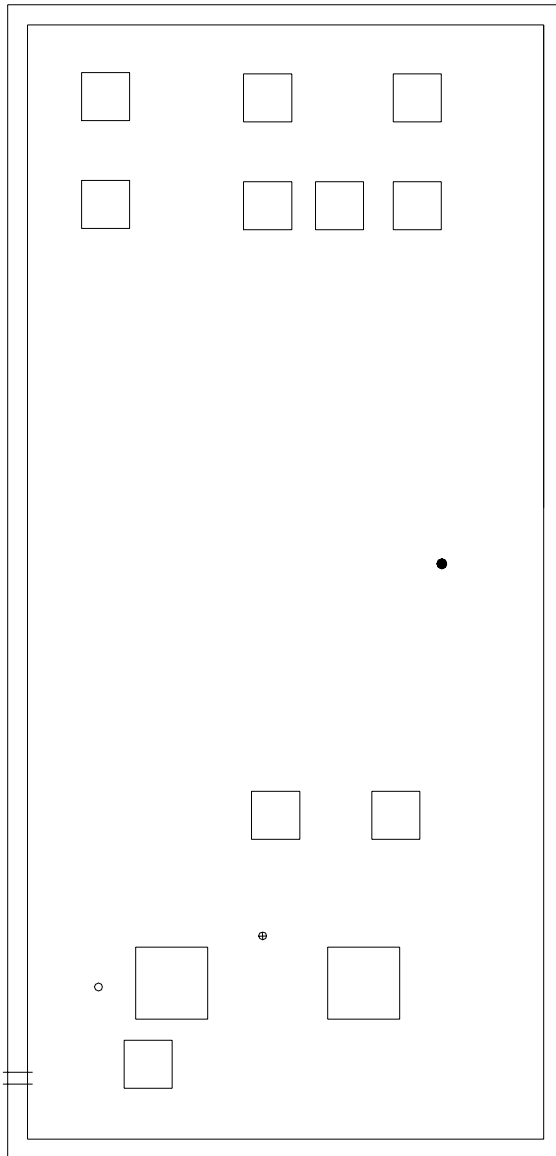

- SYMBOLS KEY**
- ROOF CURB
 - ROOF DRAIN
 - VENT STACK
 - ⊕ PIPE PENETRATION
 - †† SCUPPER

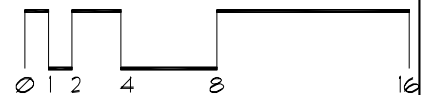

Roof Corrective Action



SYMBOLS KEY

- ≡ SLEEPER CURB
- ROOF DRAIN
- VENT STACK

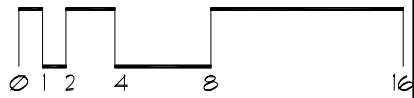
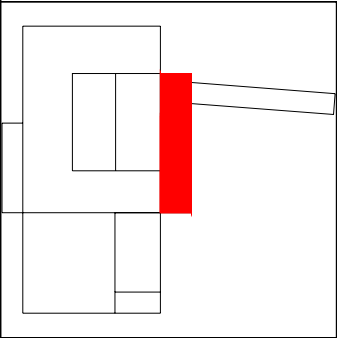

Roof Corrective Action

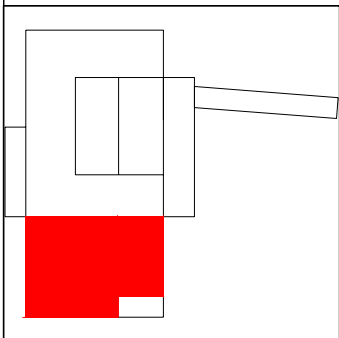

SYMBOLS KEY
● ROOF DRAIN
|| SCUPPER

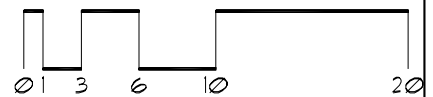

Roof Corrective Action

GUTTER

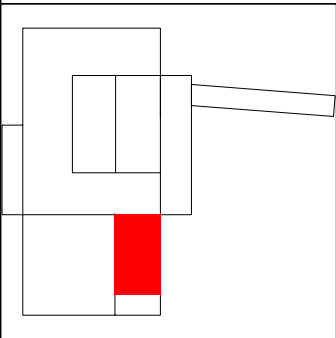

SYMBOLS KEY
|| SCUPPER

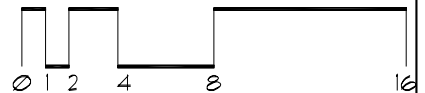

Roof Corrective Action

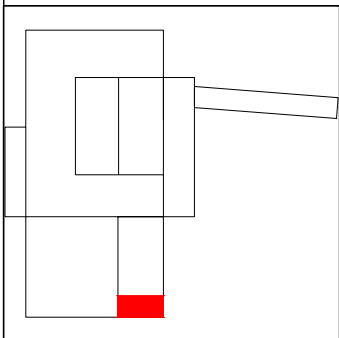
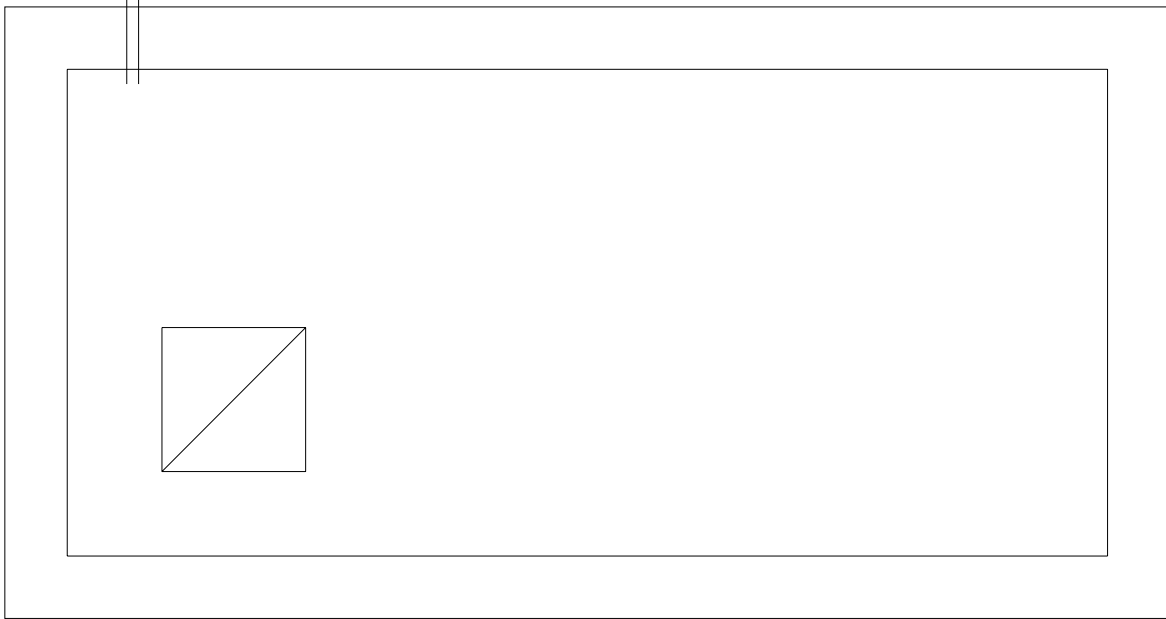

SYMBOLS KEY

- ☐ ROOF HATCH
- ☐ DEFECT-REPAIR
- ⊥ SCUPPER W/ DOWNSPOUT

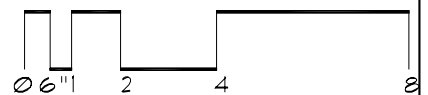

Roof Corrective Action

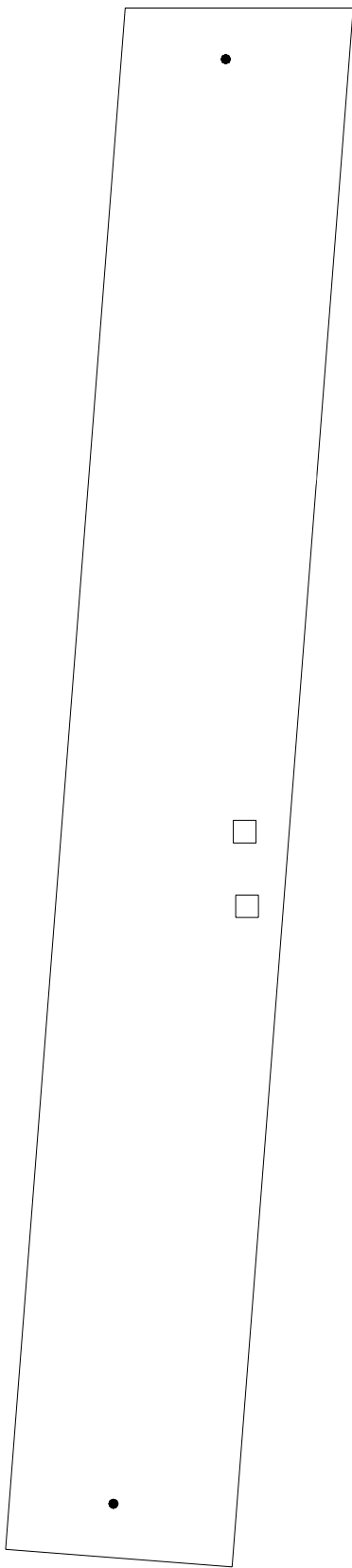

SYMBOLS KEY

- ROOF CURB
- ROOF DRAIN

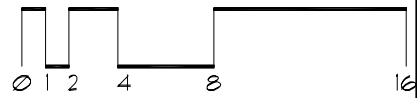
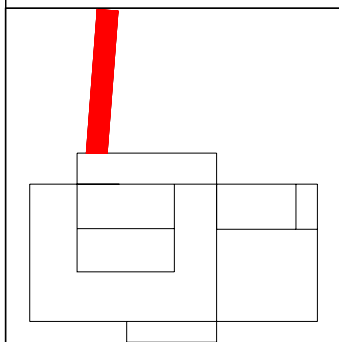

Roof Corrective Action

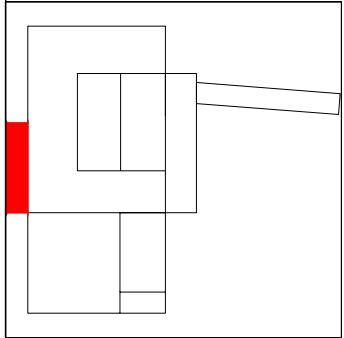
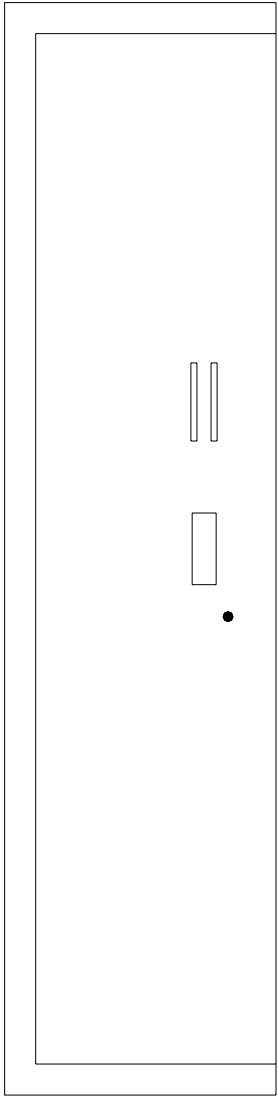

- SYMBOLS KEY**
- ROOF CURB
 - ▬ SLEEPER CURB
 - ROOF DRAIN

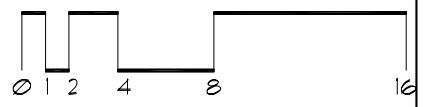

Roof ID

Building: HS142A - Moos Tower & Bridge - (515 Delaware Street SE Minneapolis)

Roof Access: Elevator to 19th floor, go upstairs to 20th and out mechanical room door:Z3key

Total Area: 14,697 sf

A	1,360 sf	E	420 sf	J	3,064 sf	O	182 sf	S	414 sf	W	168 sf
B	150 sf	F	392 sf	L	854 sf	P	272 sf	T	1,116 sf	X	680 sf
C	1,280 sf	H	1,116 sf	M	88 sf	Q	88 sf	U	980 sf	Y	81 sf
D	106 sf	I	150 sf	N	210 sf	R	1,000 sf	V	400 sf	Z	126 sf

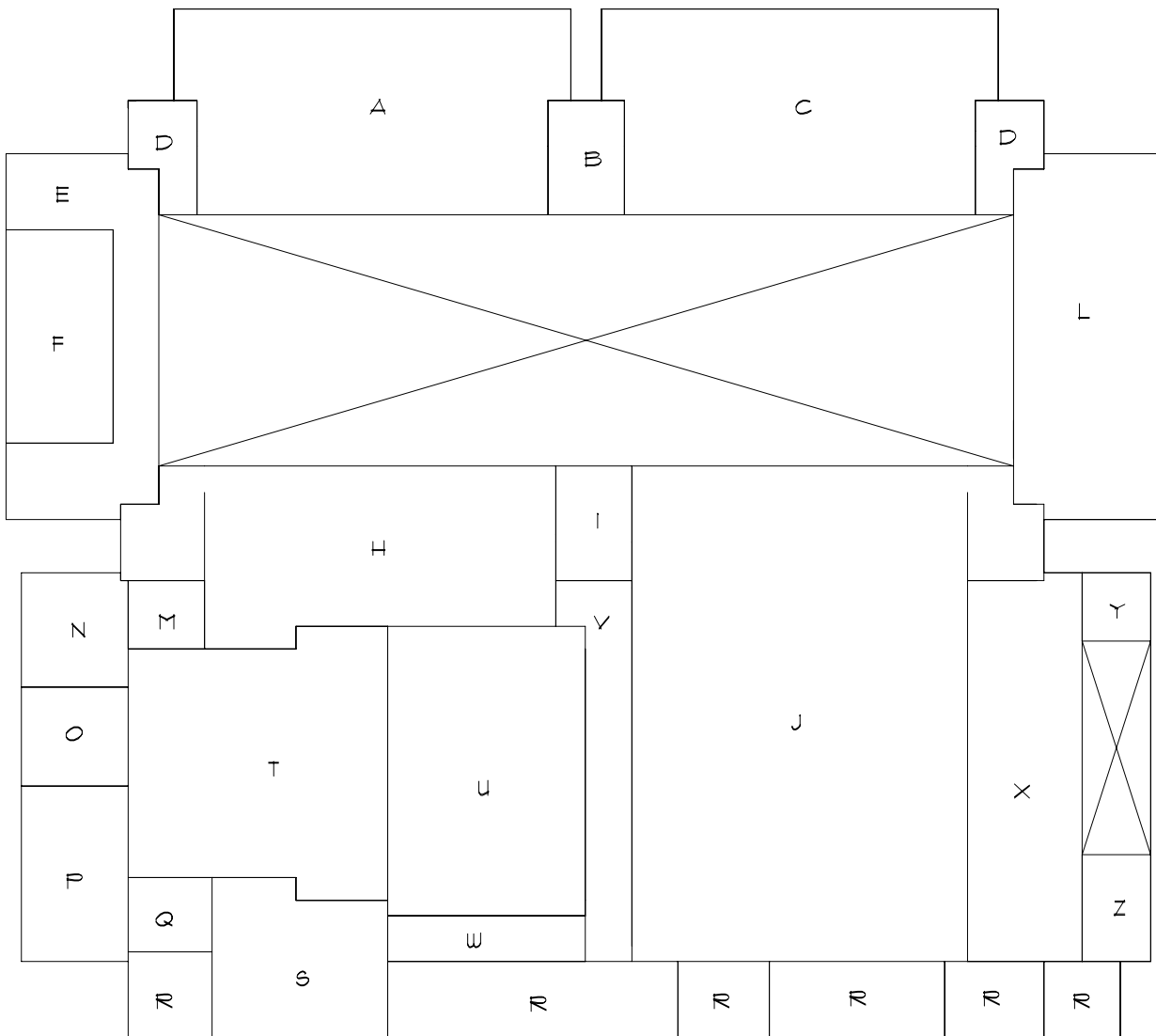

Roof Corrective Action

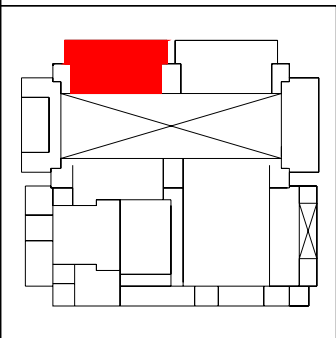
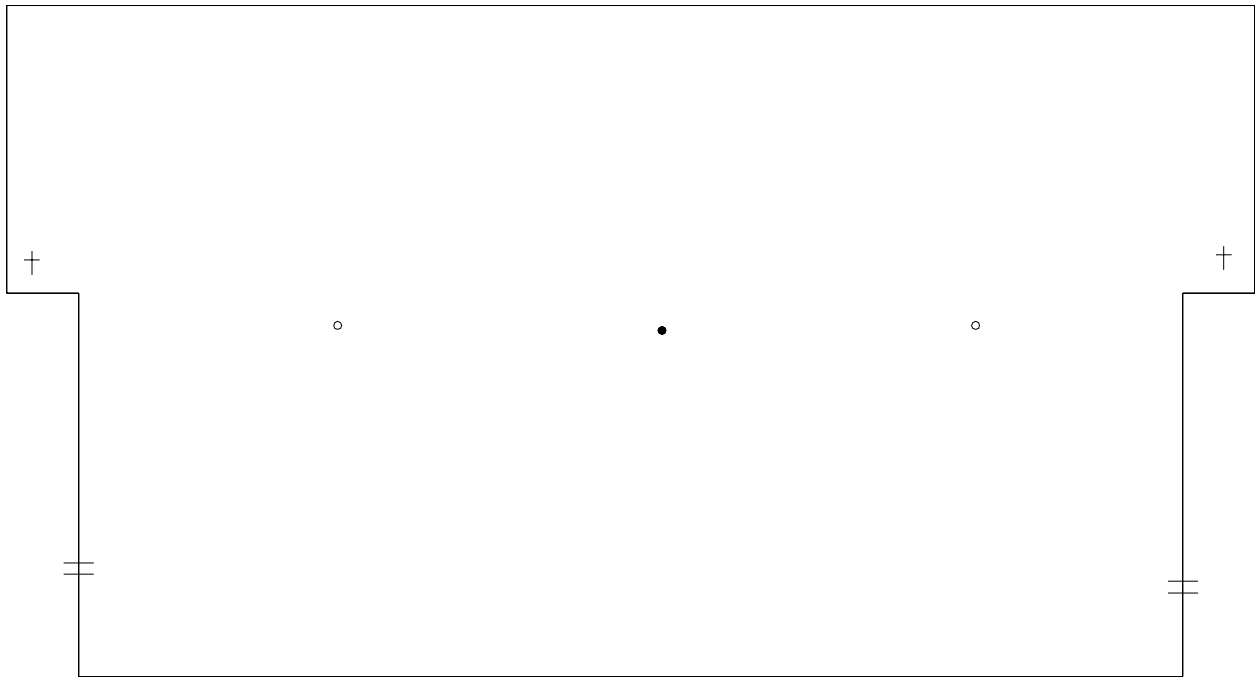

SYMBOLS KEY

- ROOF DRAIN
- VENT STACK
- † LIGHTNING PROTECTION
- ≡ THROUGH CJ OVERFLOW SCUPPER

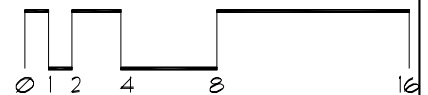

Roof Corrective Action

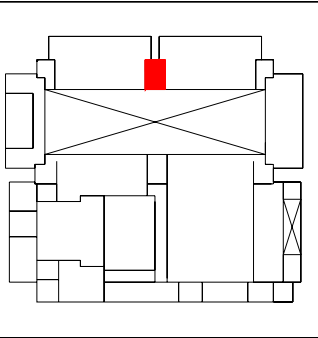
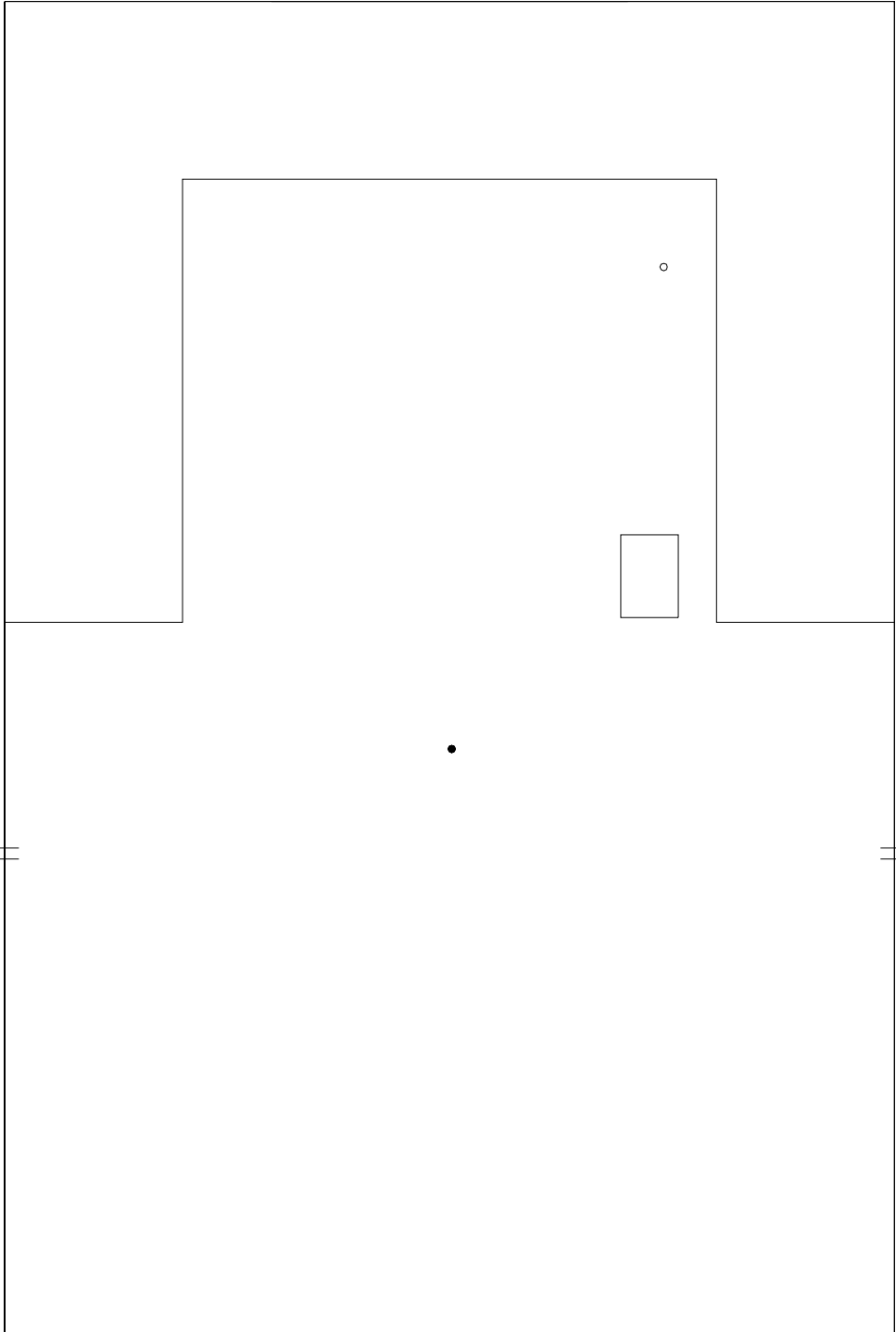

SYMBOLS KEY

- VENT STACK
- ROOF DRAIN
- †† THROUGH CJ OVERFLOW SCUPPER

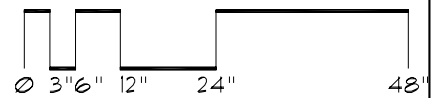

Roof Corrective Action

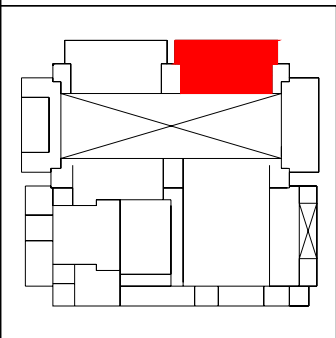
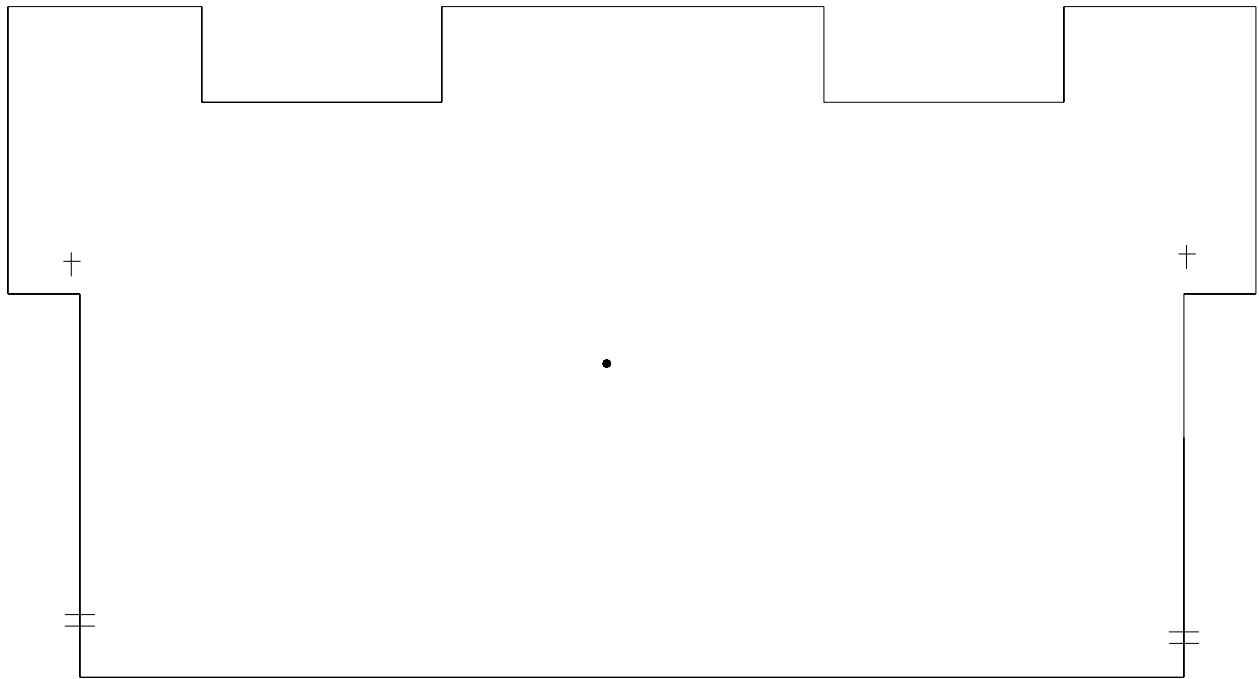

SYMBOLS KEY

- ROOF DRAIN
- + LIGHTNING PROTECTION
- || THROUGH CJ OVERFLOW SCUPPER
- DEFECT-REPAIR

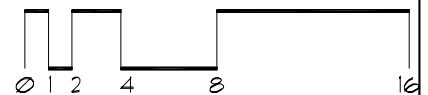

Roof Corrective Action

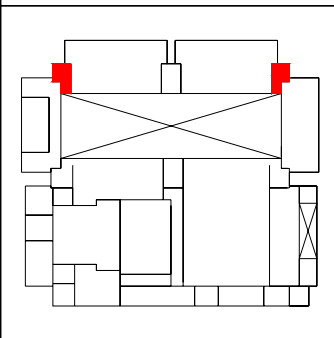
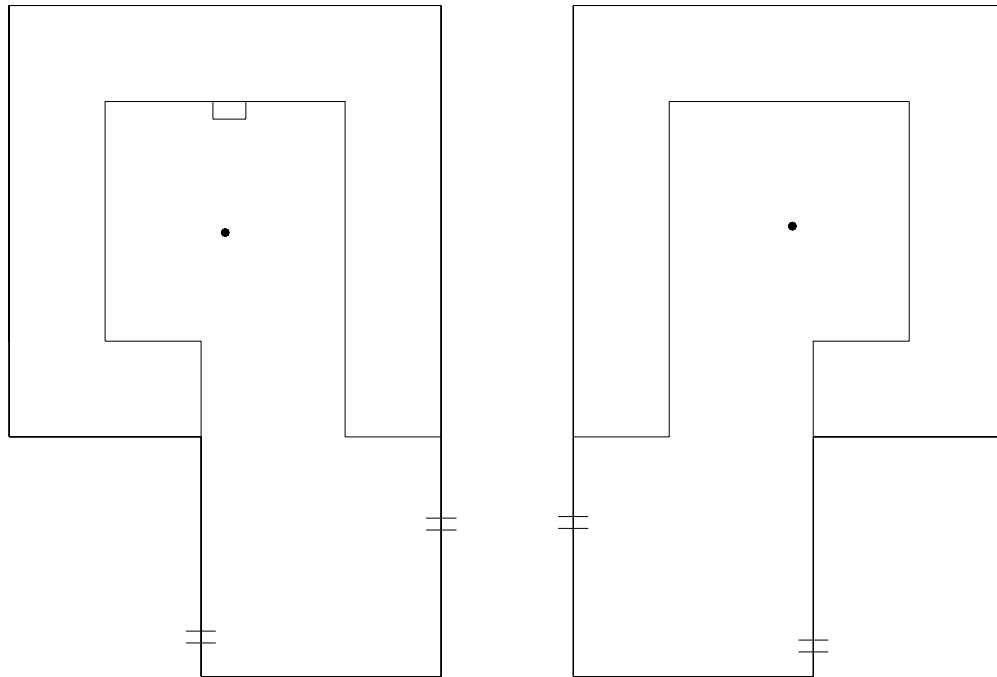

SYMBOLS KEY

- ROOF DRAIN
- ⊢ THROUGH CJ OVERFLOW SCUPPER
- ROOF CURB
- Ⓢ DEFECT-REPAIR

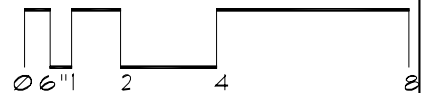

Roof Corrective Action

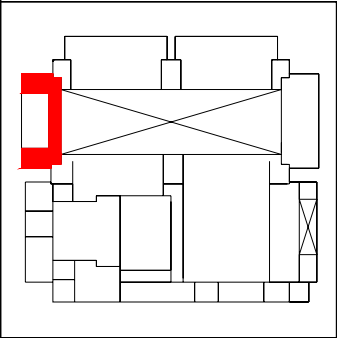
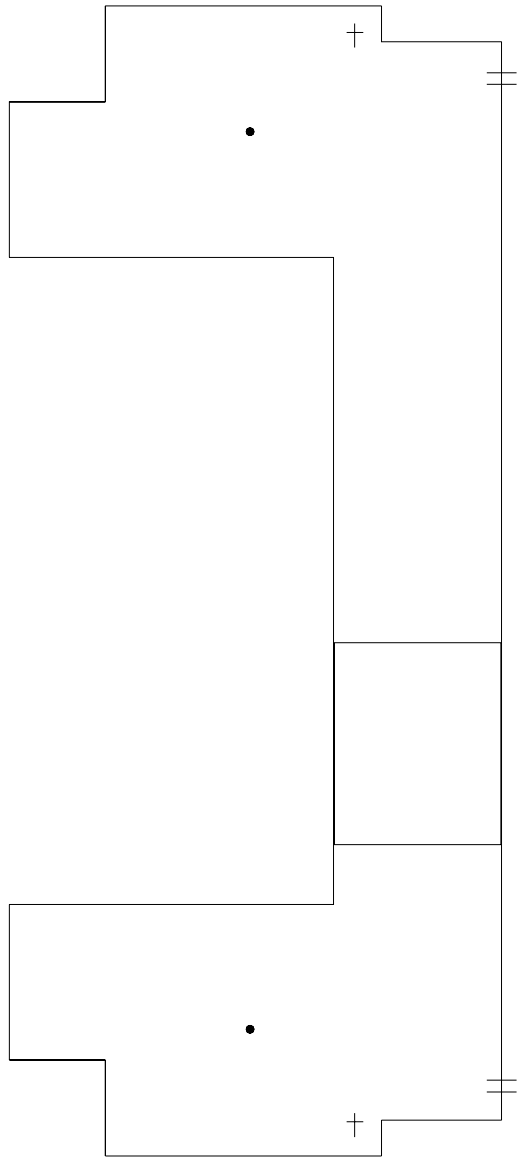

- SYMBOLS KEY**
- ROOF DRAIN
 - ROOF CURB
 - † LIGHTNING PROTECTION
 - ⦶ THROUGH CJ OVERFLOW SCUPPER

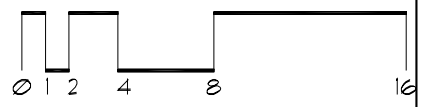

Roof Corrective Action

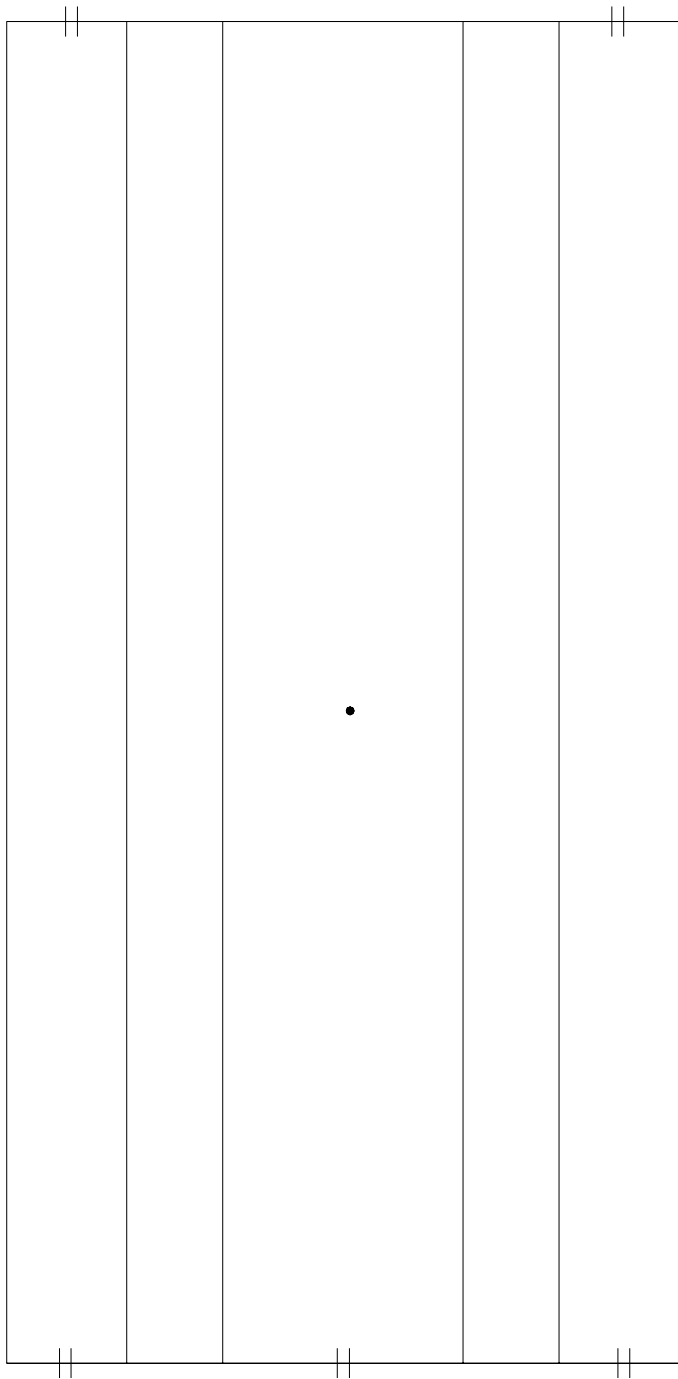

OF

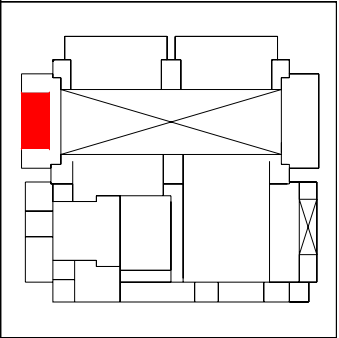

- SYMBOLS KEY**
- ROOF DRAIN
 - †† SCUPPER OF OVERFLOW SCUPPER

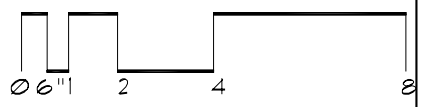

Roof Corrective Action

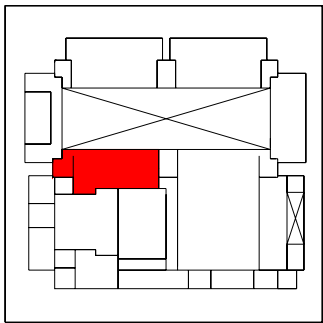
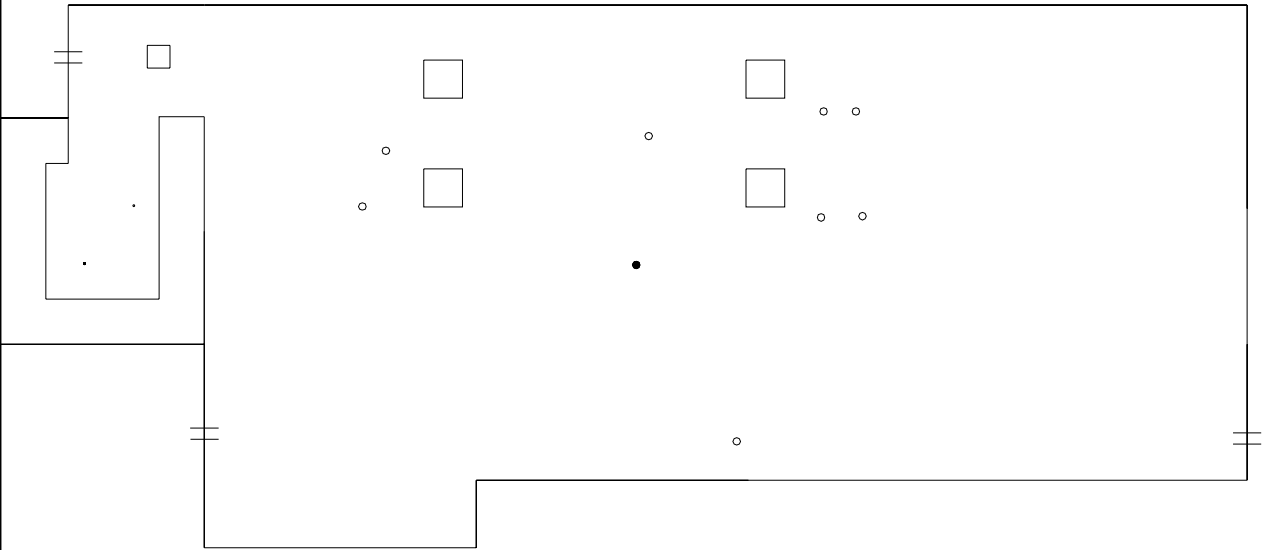

SYMBOLS KEY

- VENT STACK
- ROOF DRAIN
- ROOF CURB
- ≡ THROUGH CJ OVERFLOW SCUPPER
DEFECT-REPAIR

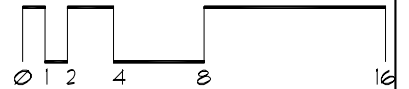

Roof Corrective Action

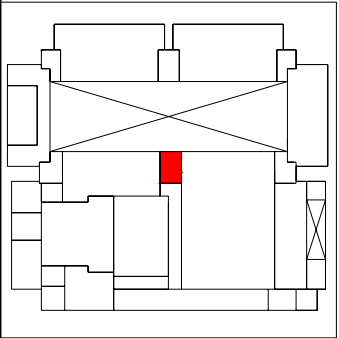
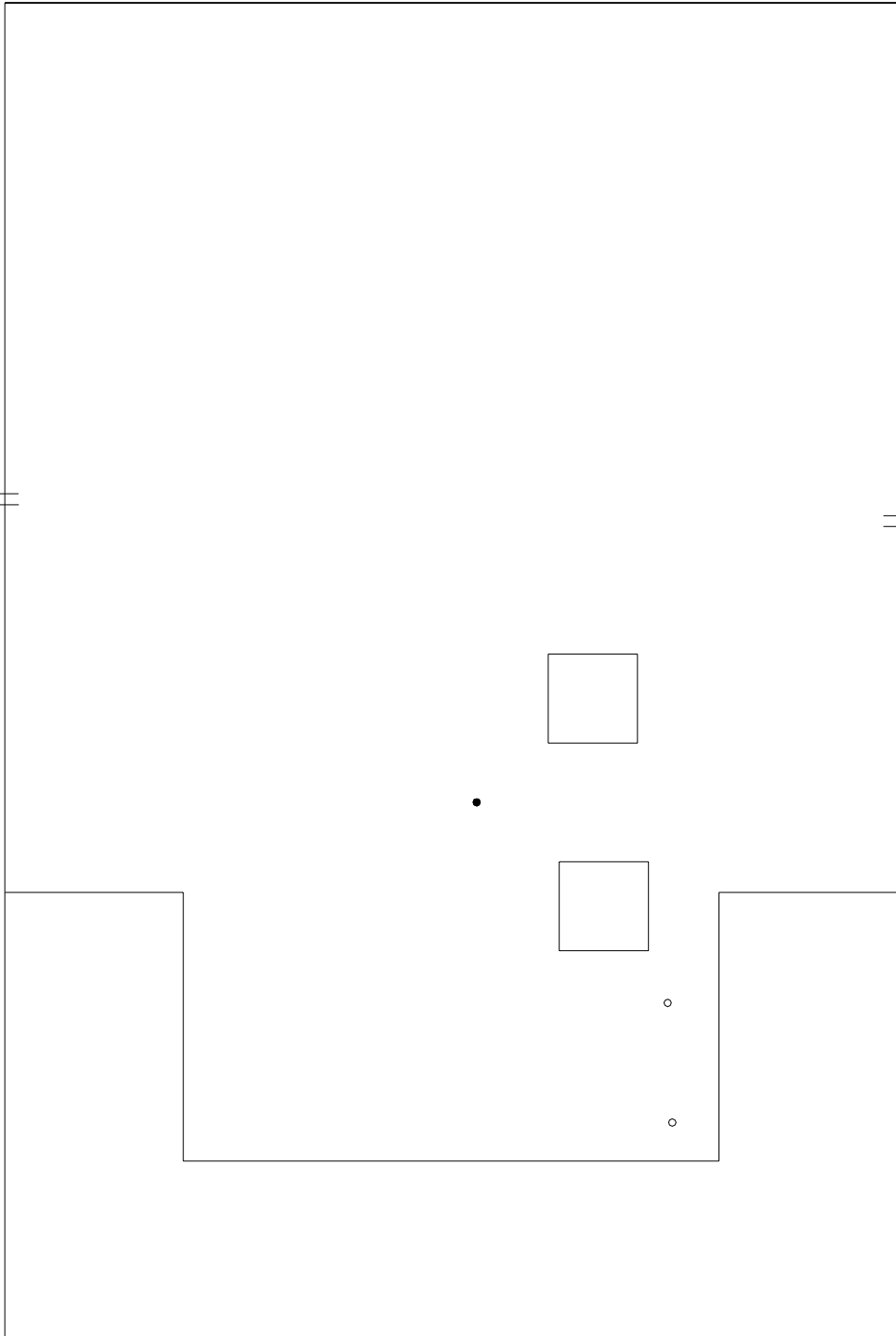

SYMBOLS KEY

- ROOF DRAIN
- VENT STACK
- ROOF CURB
- †† THROUGH CJ OVERFLOW SCUPPER

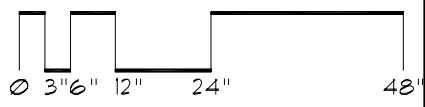

Roof Corrective Action

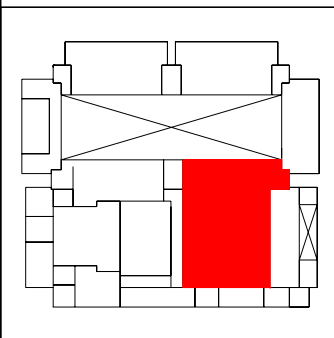
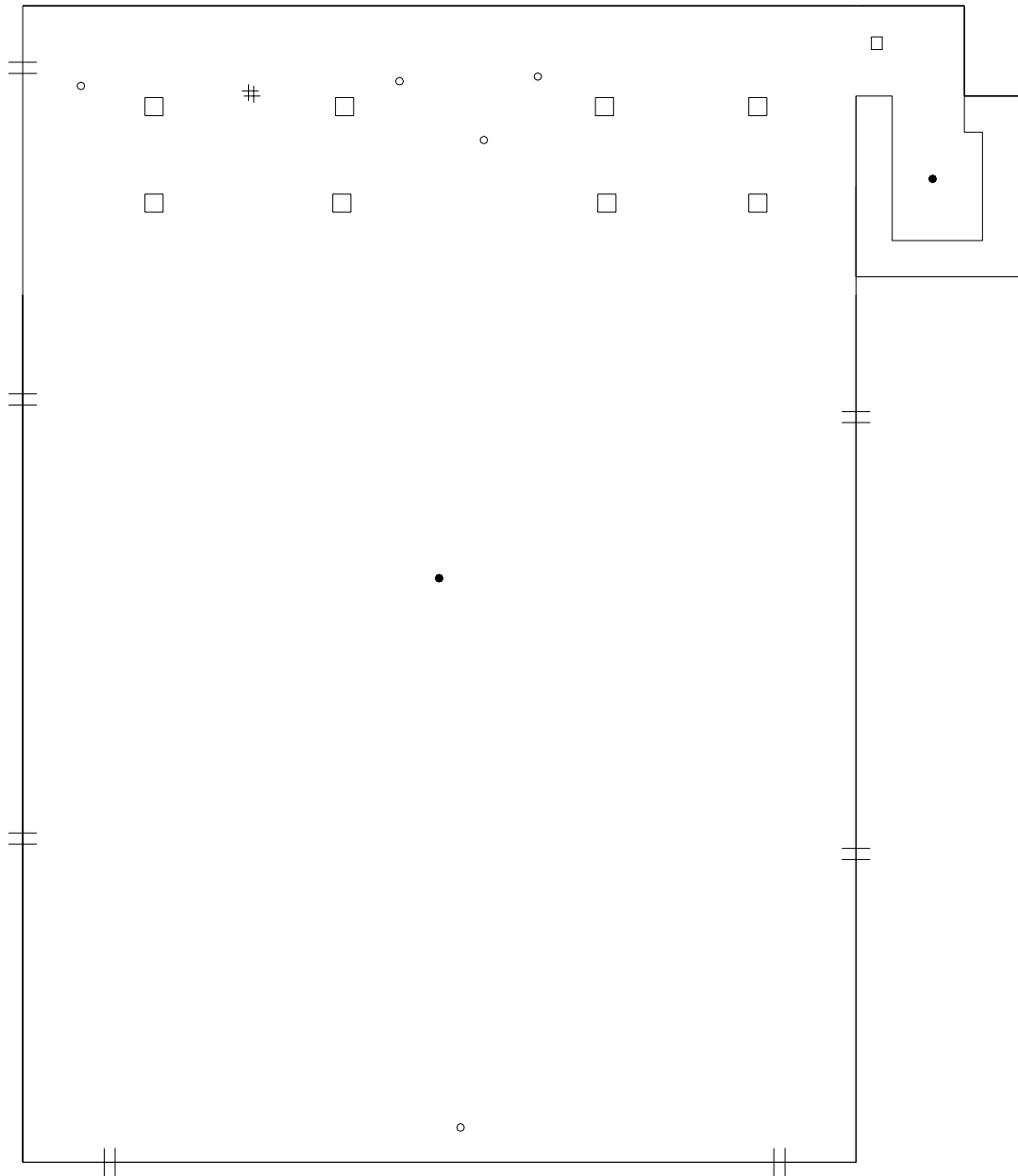

SYMBOLS KEY

- VENT STACK
- ROOF DRAIN
- ROOF CURB
- # PITCH PAN
- ≡≡ THROUGH CJ OVERFLOW SCUPPER

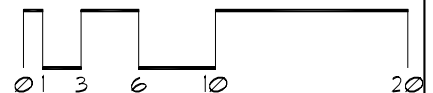

Roof Corrective Action

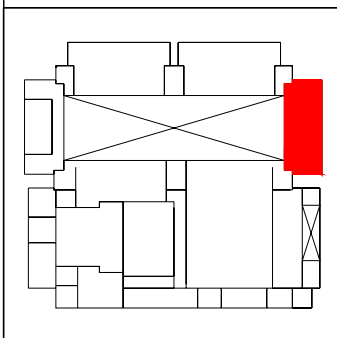
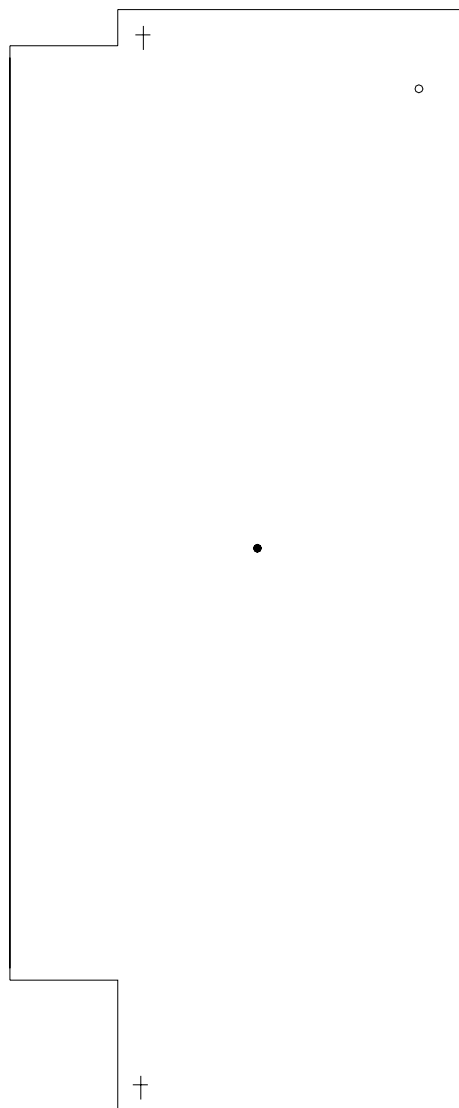

- SYMBOLS KEY**
- ROOF DRAIN
 - † LIGHTNING PROTECTION
 - o VENT STACK
 - Ⓢ DEFECT-REPAIR

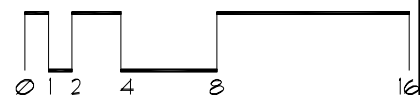

Roof Corrective Action

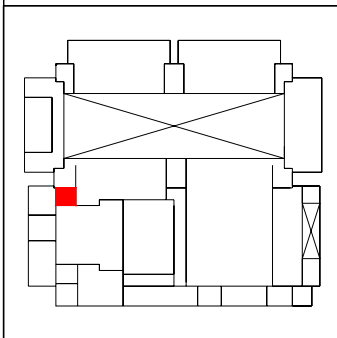
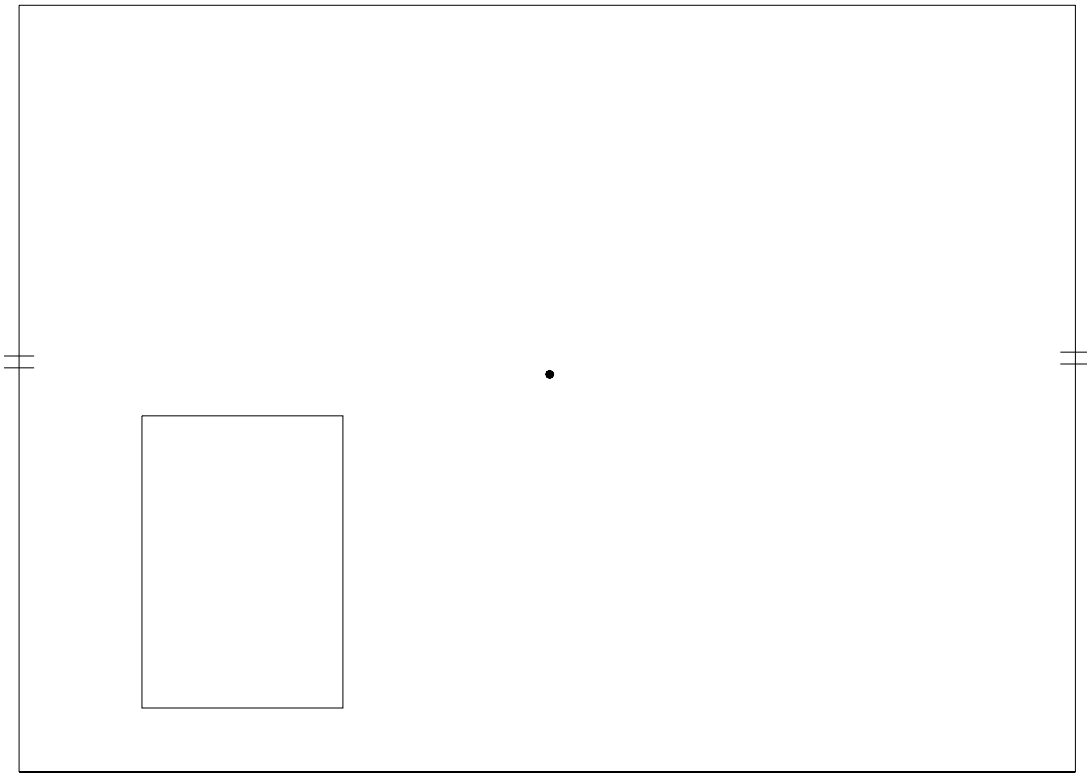

- SYMBOLS KEY
- ROOF DRAIN
 - †† THROUGH CJ OVERFLOW SCUPPER
 - ⓪ DEFECT-NO REPAIR

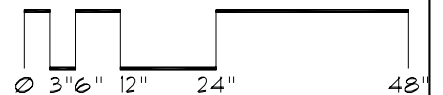

Roof Corrective Action

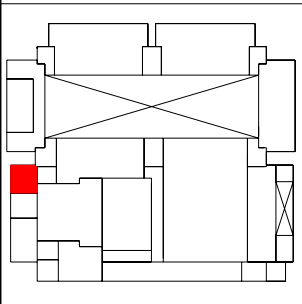
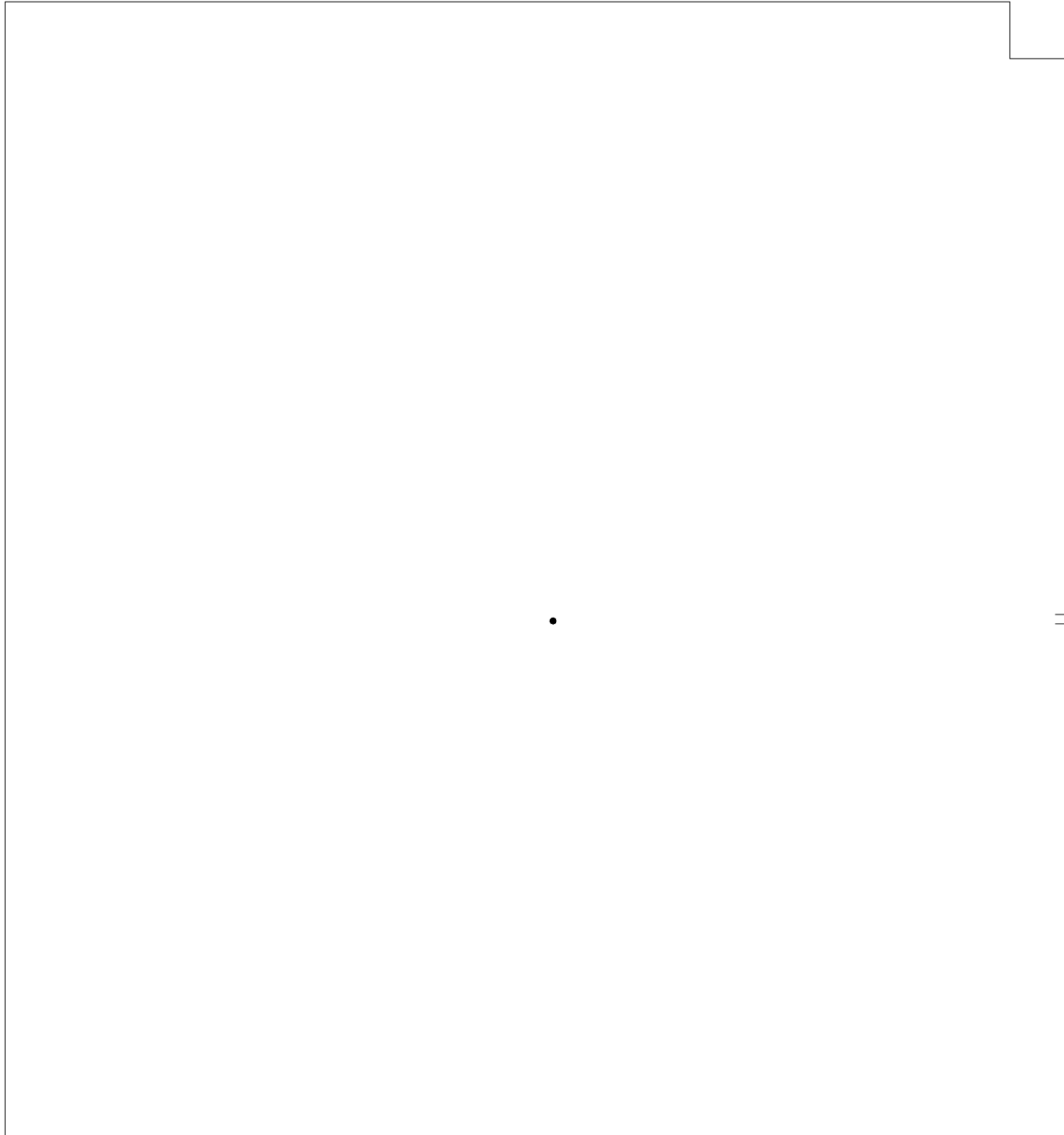

SYMBOLS KEY

- ROOF DRAIN
- †† THROUGH CJ OVERFLOW SCUPPER

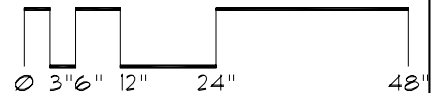

Roof Corrective Action

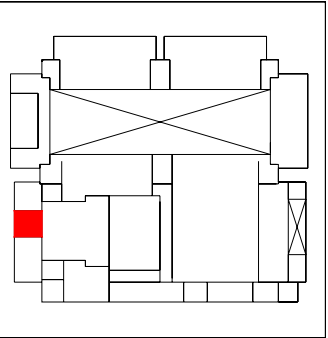
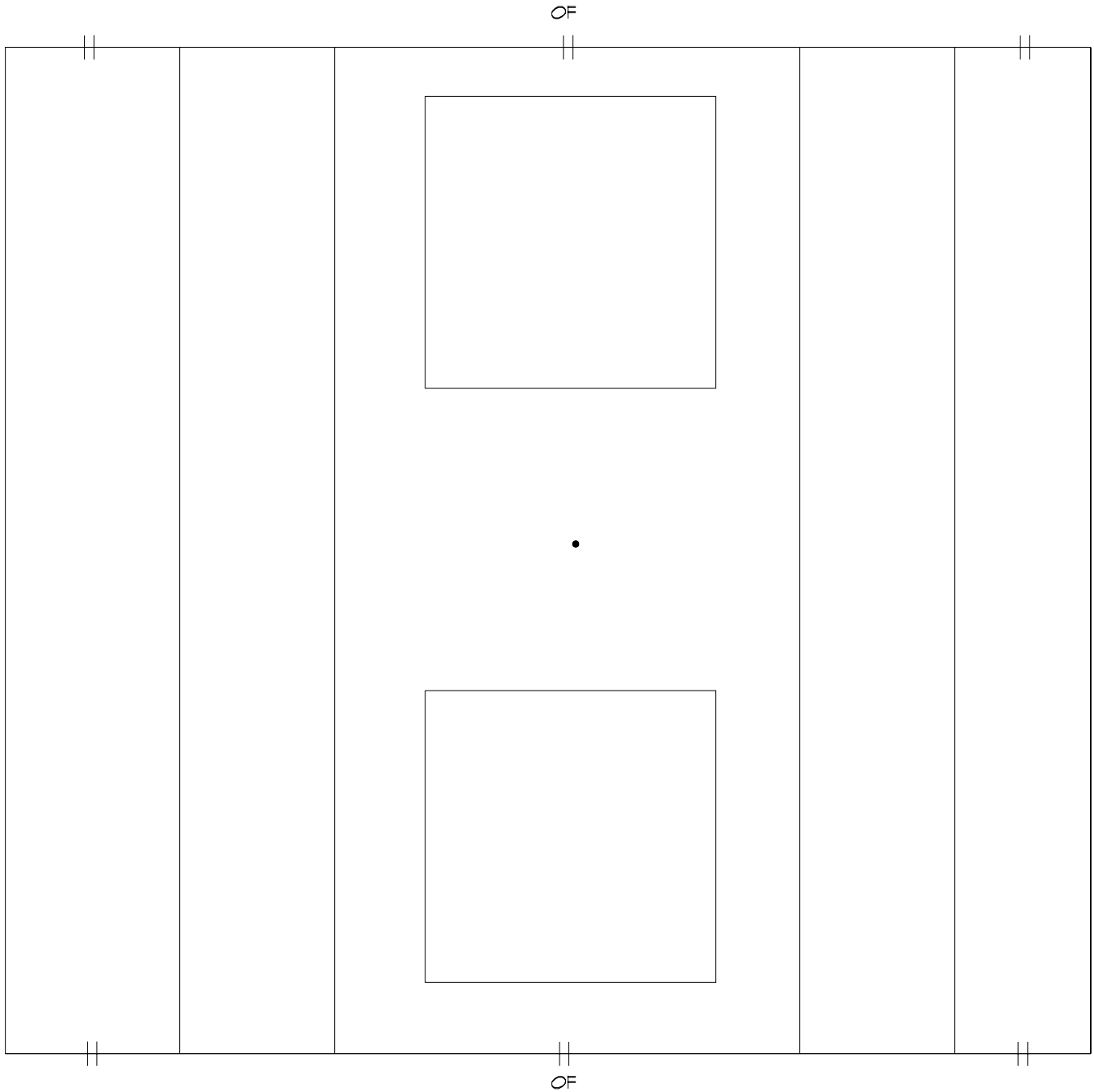

- SYMBOLS KEY**
- ROOF DRAIN
 - ROOF CURB
 - OF OVERFLOW SCUPPER
 - †† SCUPPER

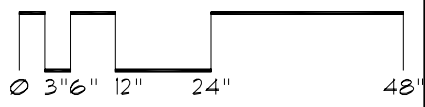
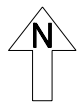

Roof Corrective Action

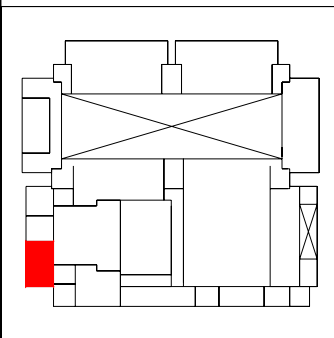
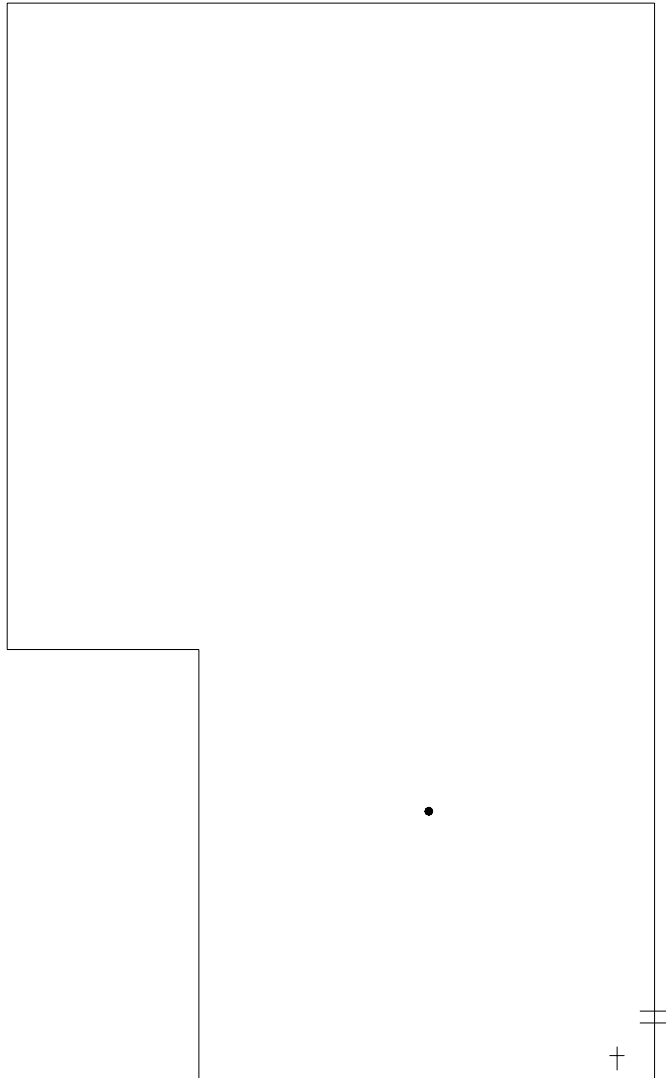

SYMBOLS KEY

- ROOF DRAIN
- ⦶ THROUGH CJ OVERFLOW SCUPPER
- ⦶ LIGHTNING PROTECTION

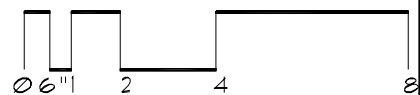

Roof Corrective Action

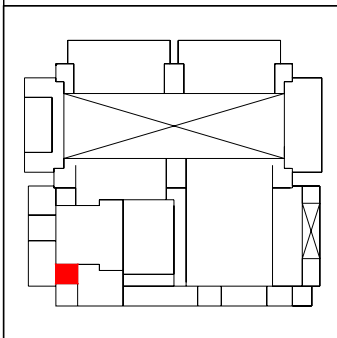
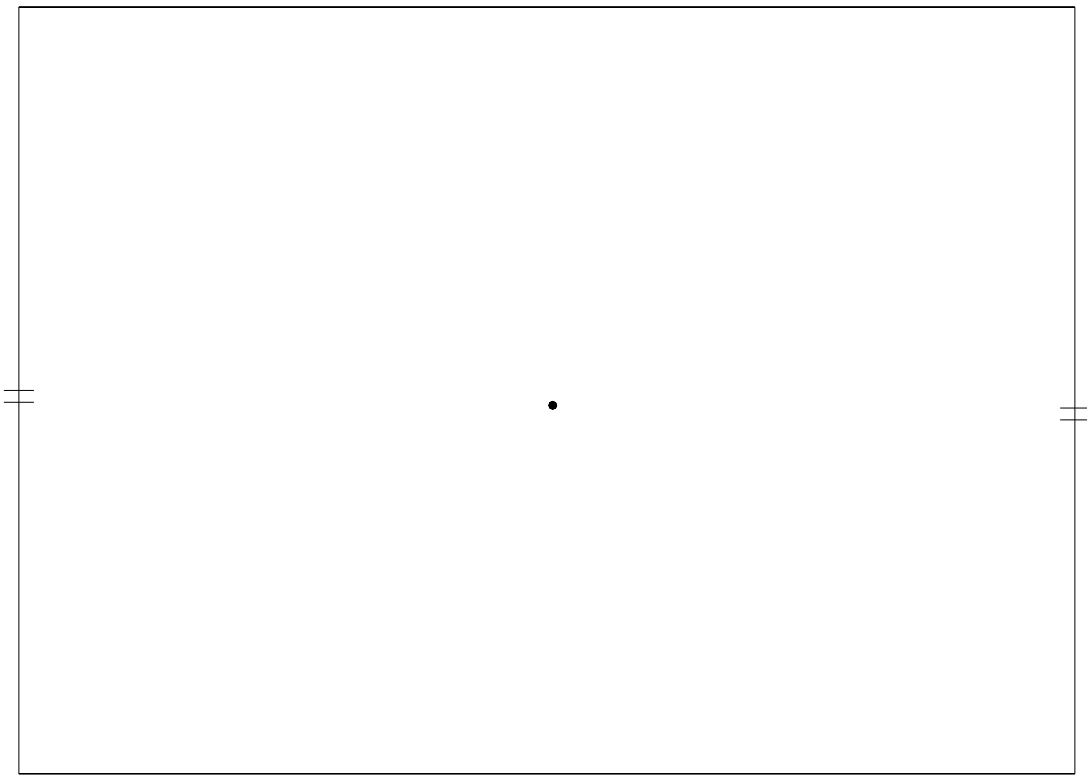

SYMBOLS KEY

- ROOF DRAIN
- ≡ THROUGH CJ OVERALL SCUPPER
- ① DEFECT-NO REPAIR

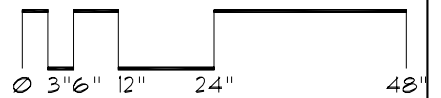
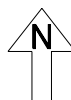

Roof Corrective Action

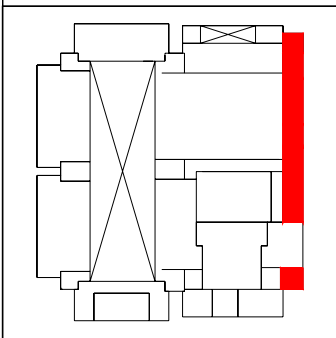
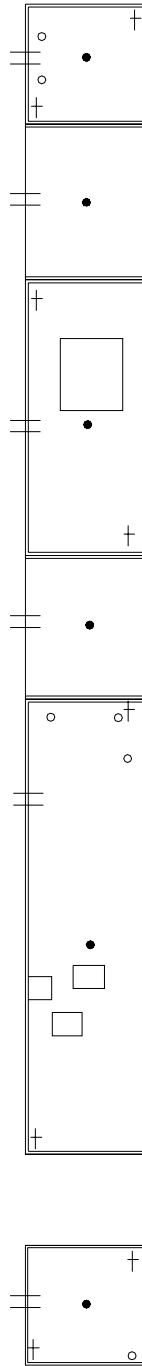

SYMBOLS KEY

- VENT STACK
- ROOF DRAIN
- ROOF CURB
- ⦶ THROUGH CURB OVERFLOW/OVERFLOW SCUPPER
- ⊕ LIGHTING PROTECTION
- ⊠ ROOF HATCH
- ▣ DEFECT-REPAIR

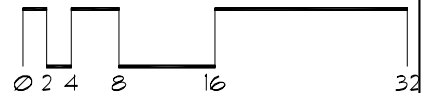

Roof Corrective Action

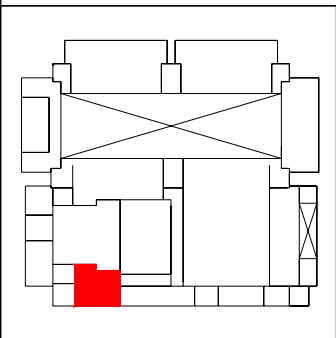
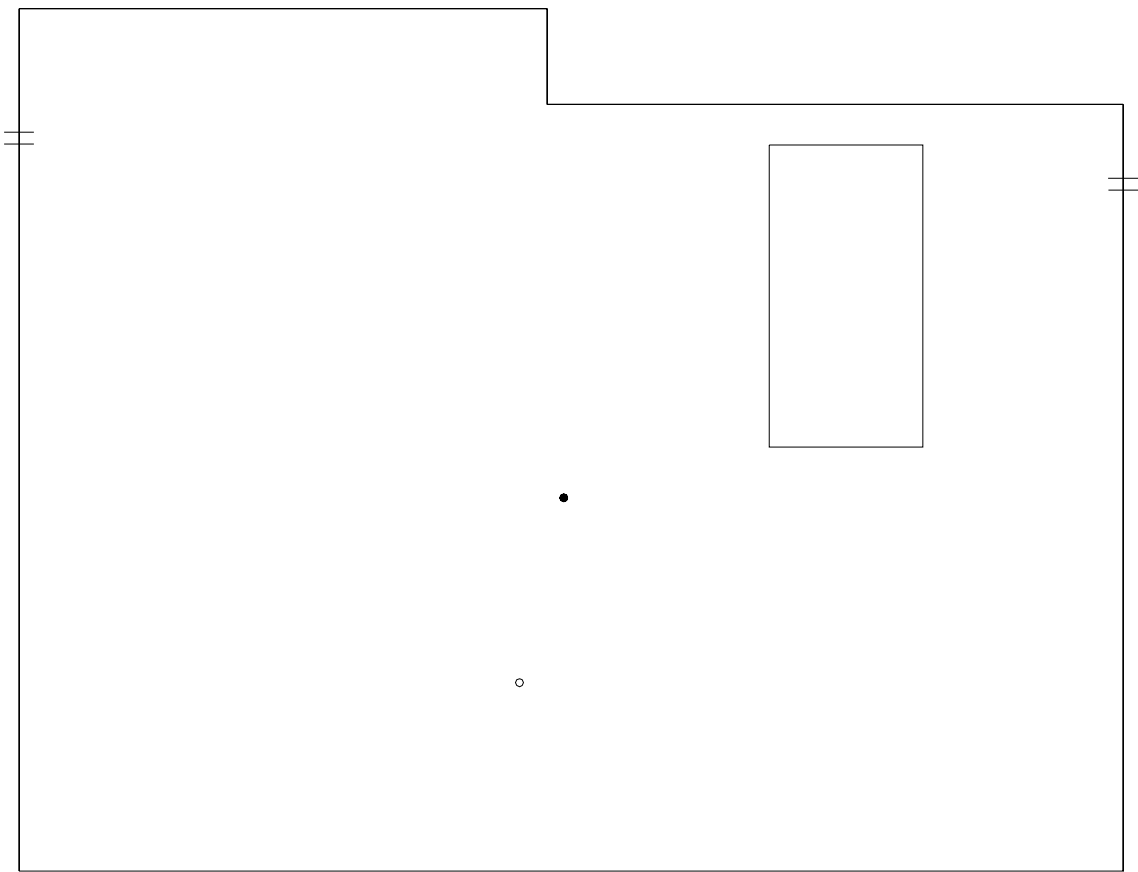

SYMBOLS KEY

- VENT STACK
- ROOF DRAIN
- ROOF CURB
- †† THROUGH CJ OVERFLOW SCUPPER
- DEFECT-REPAIR

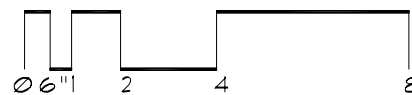

Roof Corrective Action

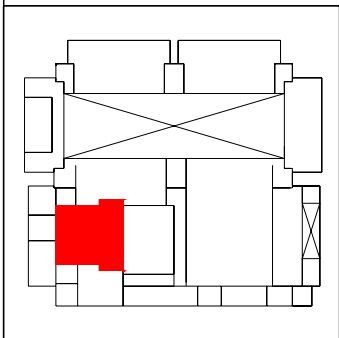
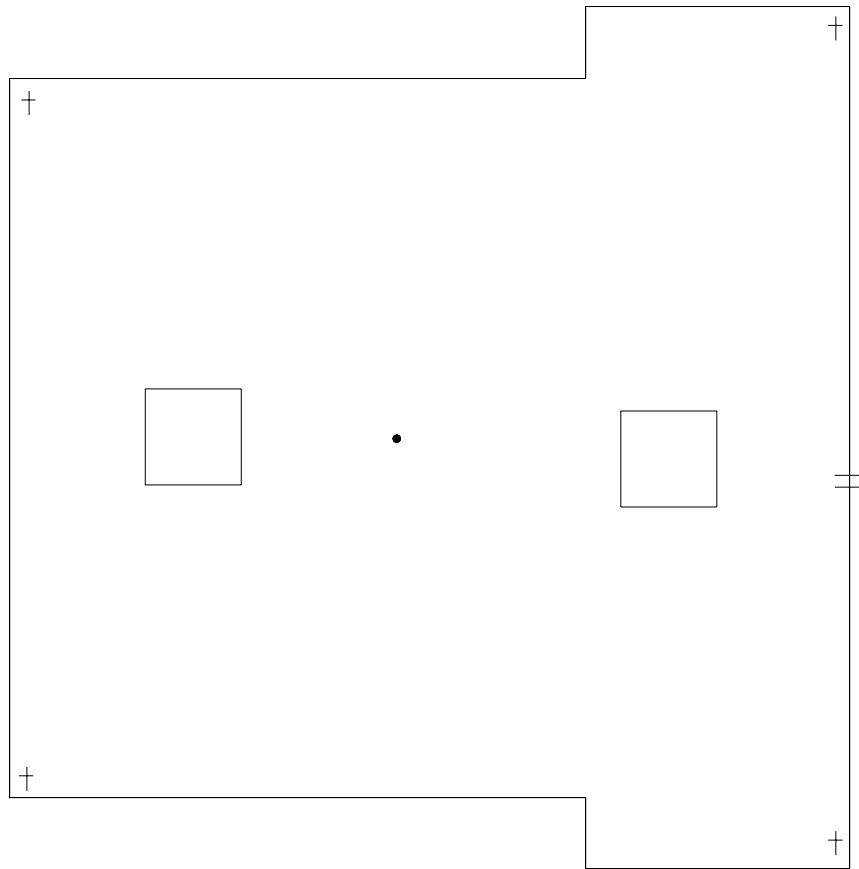

SYMBOLS KEY

- ROOF DRAIN
- ROOF CURB
- † LIGHTNING PROTECTION
- ≡ OVERFLOW SCUPPER

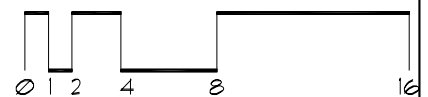

Roof Corrective Action

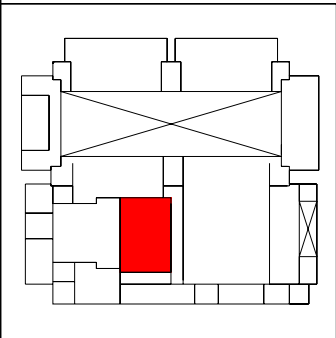
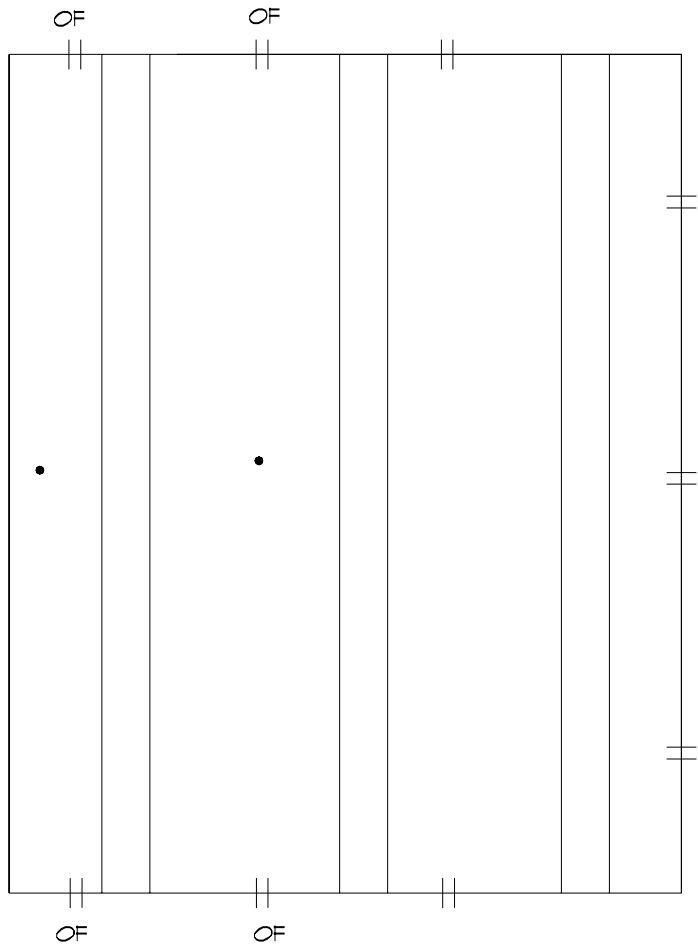

SYMBOLS KEY
 OF THROUGH CJ OVERFLOW SCUPPER
 † SCUPPER
 • ROOF DRAIN

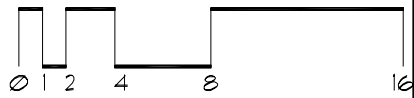

Roof Corrective Action

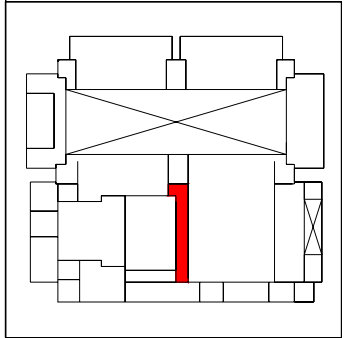
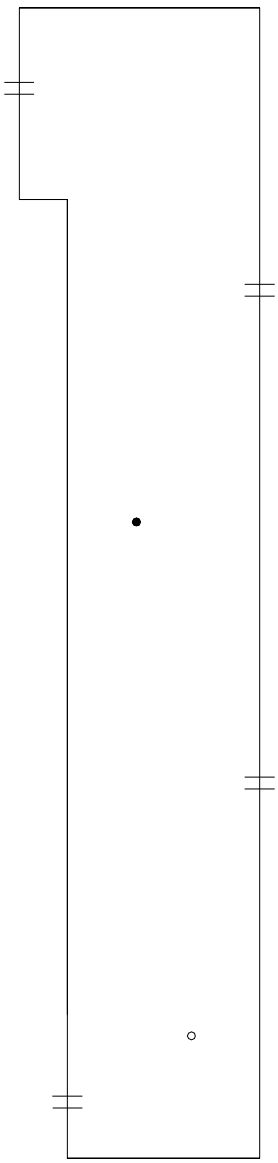

- SYMBOLS KEY**
- ROOF DRAIN
 - VENT STACK
 - ≡≡ THROUGH THE ROOF SCUPPER

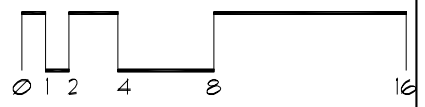
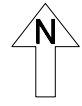

Roof Corrective Action

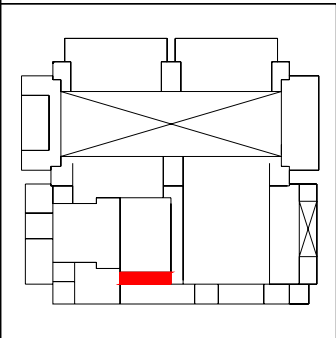
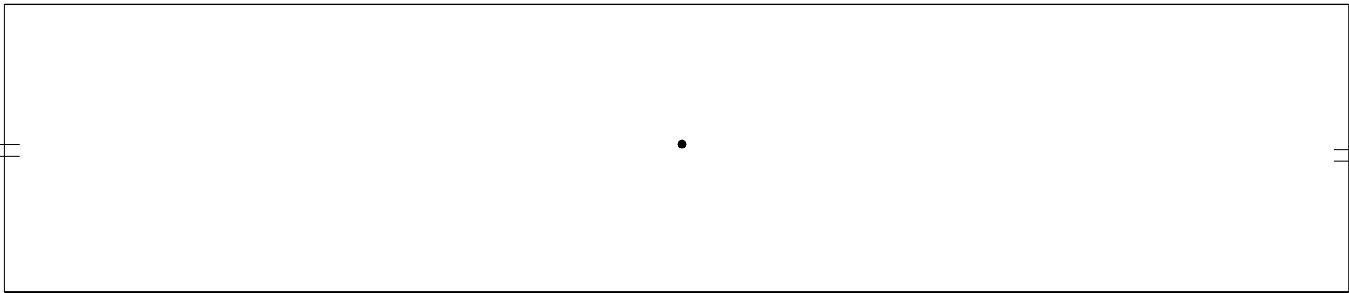

SYMBOLS KEY

- ROOF DRAIN
- †† THROUGH CJ OVERFLOW SCUPPER

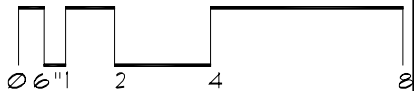

Roof Corrective Action

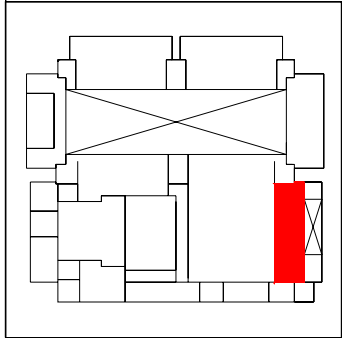
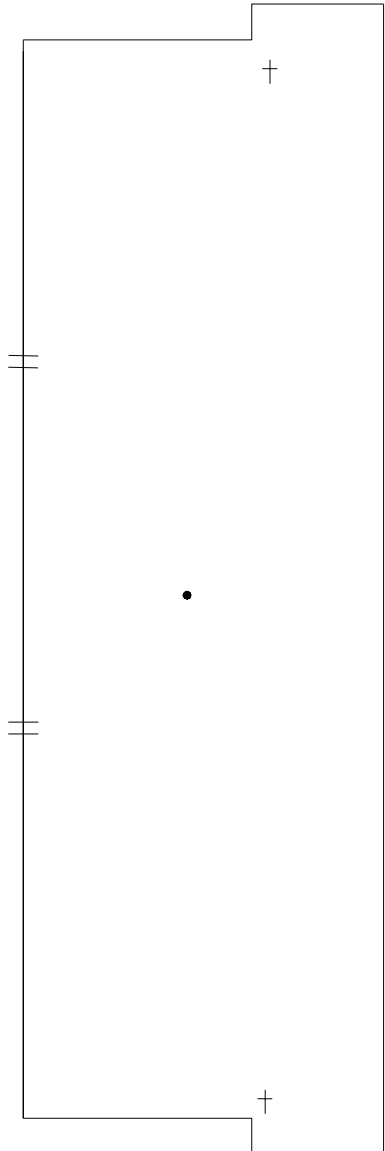

SYMBOLS KEY
● ROOF DRAIN
† LIGHTNING PROTECTION

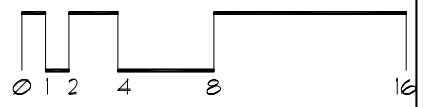

Roof Corrective Action

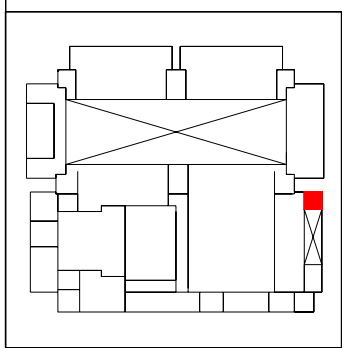
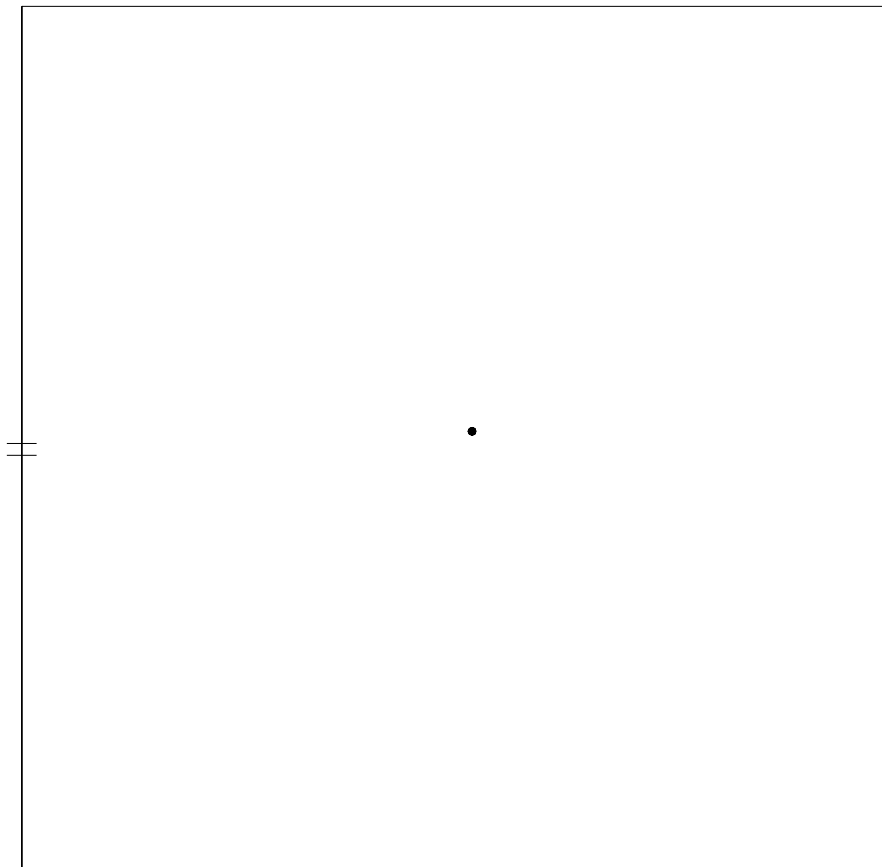

SYMBOLS KEY
• ROOF DRAIN
⊕ THROUGH CJ OVERFLOW SCUPPER

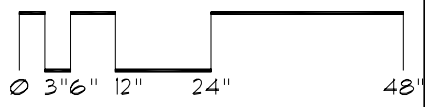
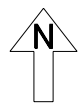

Roof Corrective Action

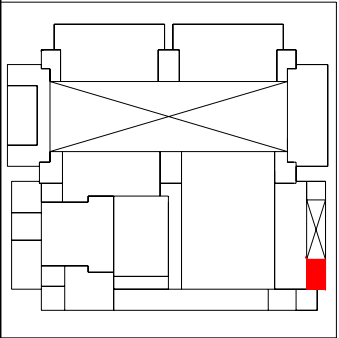
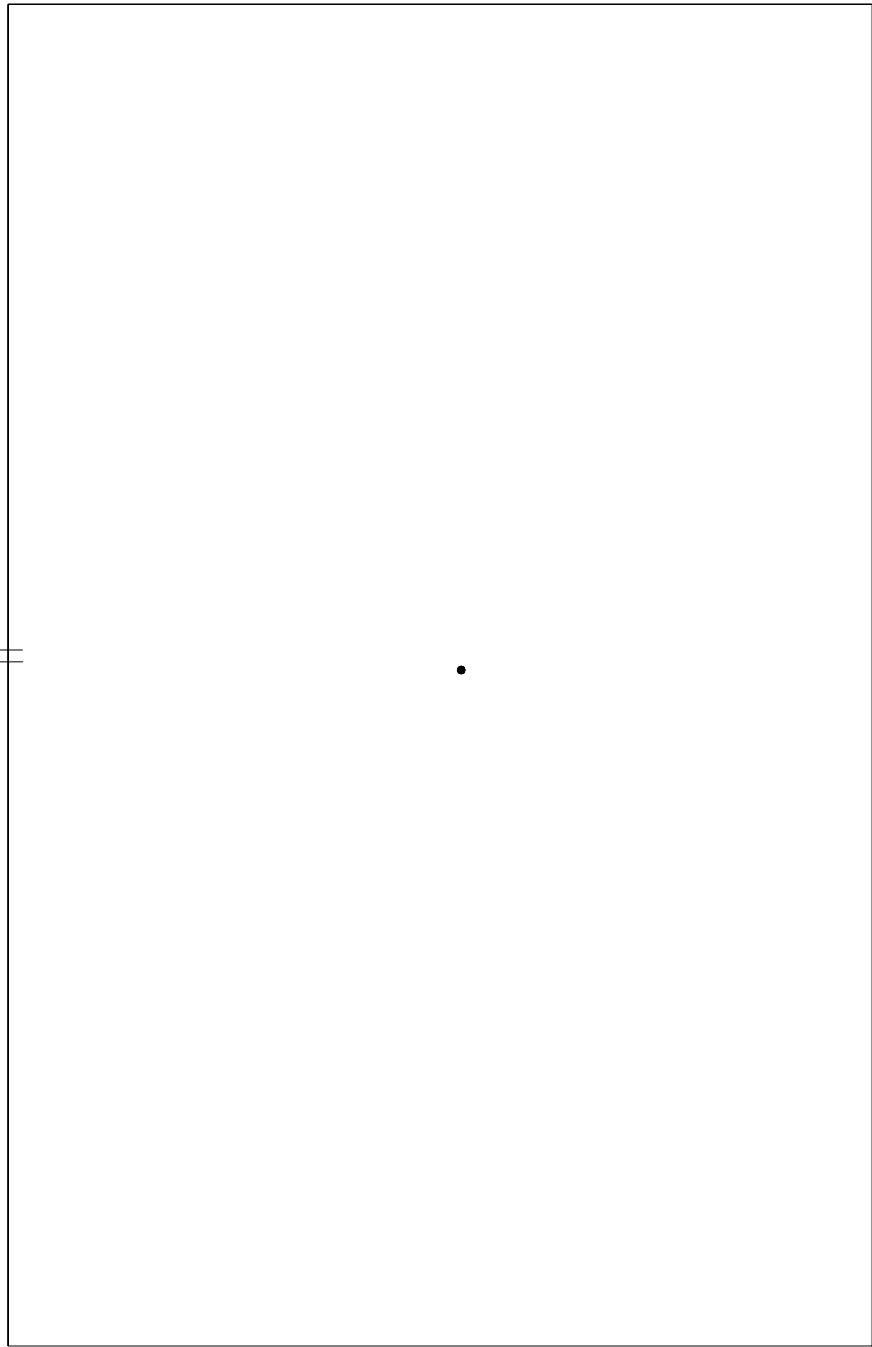

SYMBOLS KEY

- ROOF DRAIN
- †† THROUGH CJ OVERFLOW SCUPPER

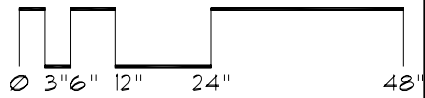

Roof ID

Building: HS142B - Moos Tower and Bridge - (515 Delaware Street SE Minneapolis)

Roof Access: Section G-West Stairs, 10th floor

Total Area: 31,343 sf

A	728 sf	E	240 sf	I	400 sf	M	3,000 sf	Q	480 sf	U	726 sf
B	950 sf	F	825 sf	J	2,350 sf	N	1,560 sf	R	2,760 sf	V	726 sf
C	728 sf	G	224 sf	K	400 sf	O	1,080 sf	S	1,176 sf	W	726 sf
D	576 sf	H	210 sf	L	1,500 sf	P	2,880 sf	T	784 sf	X	200 sf



Roof ID

Building: HS142B - Moos Tower and Bridge - (515 Delaware Street SE Minneapolis)

Roof Access: Section G-West Stairs, 10th floor

Total Area: 31,343 sf

Y 6,114 sf



Roof Corrective Action

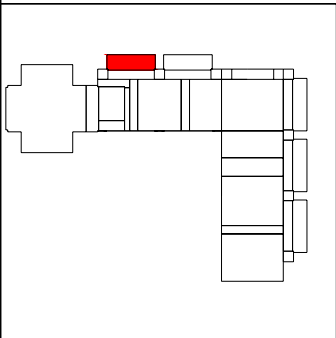
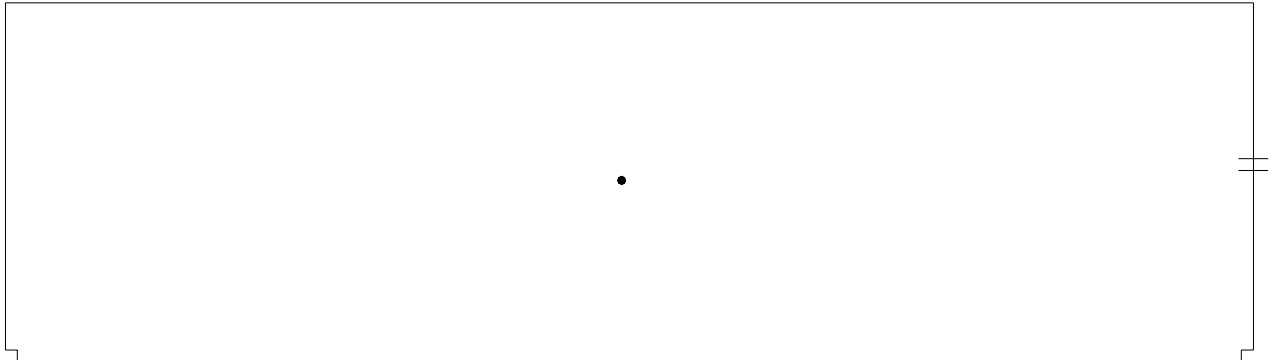

SYMBOLS KEY
|| SCUPPER
● ROOF DRAIN

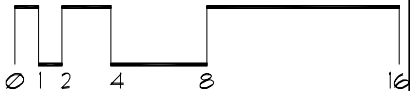

Roof Corrective Action

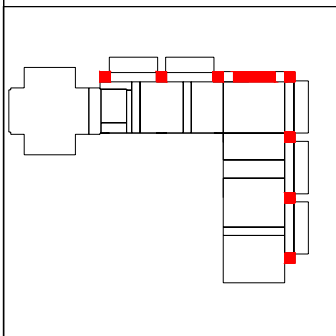
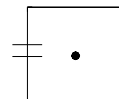
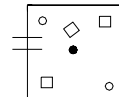
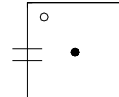
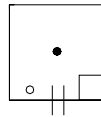
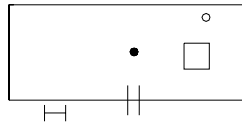
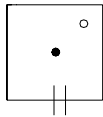
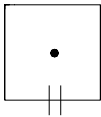
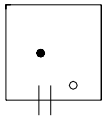

- SYMBOLS KEY**
- ROOF DRAIN
 - ROOF CURB
 - VENT STACK
 - H LADDER
 - ≡ SCUPPER

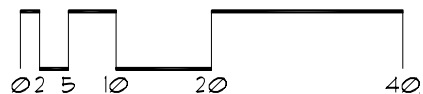

Roof Corrective Action

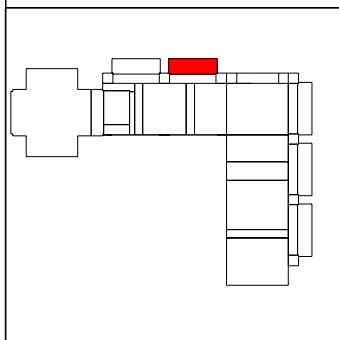
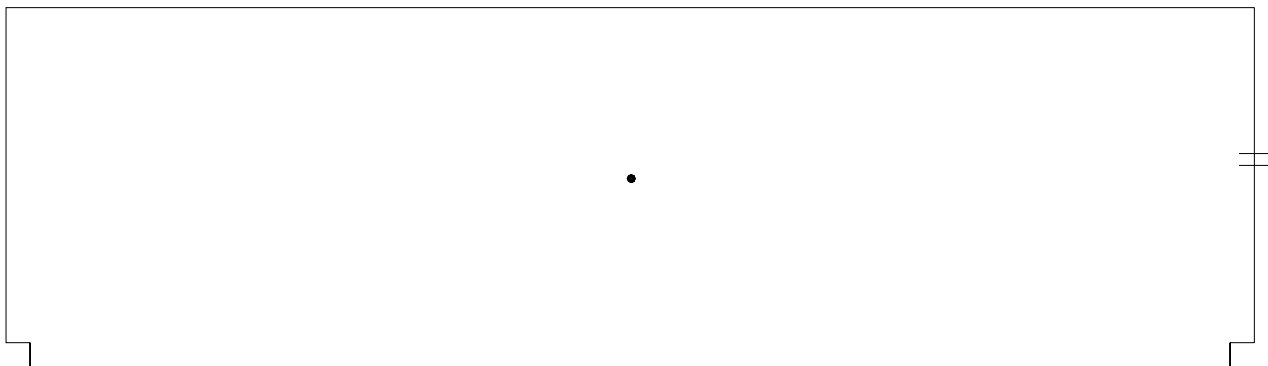

SYMBOLS KEY
● ROOF DRAIN
†† SCUPPER

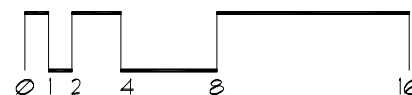

Roof Corrective Action

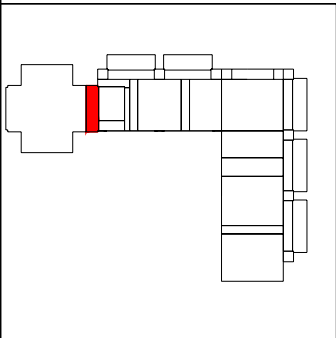
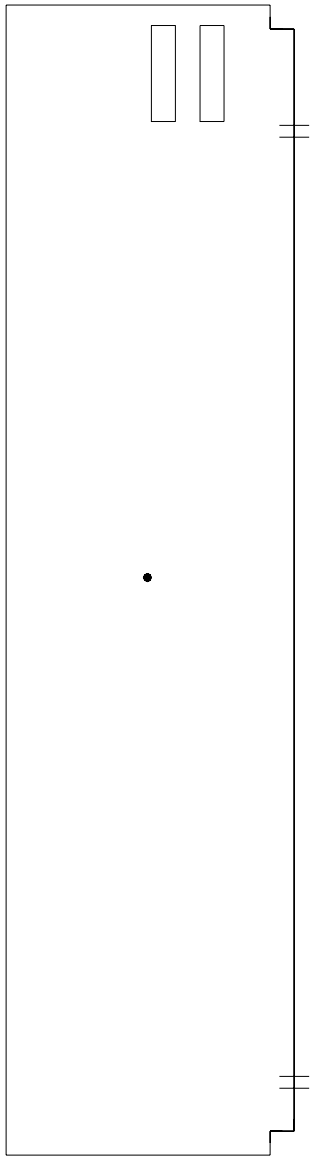

- SYMBOLS KEY**
- † SCUPPER
 - ROOF DRAIN
 - ≡ SLEEPER CURB
 - Ⓢ DEFECT-REPAIR

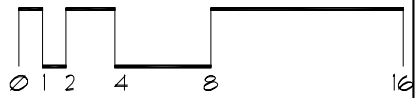

Roof Corrective Action

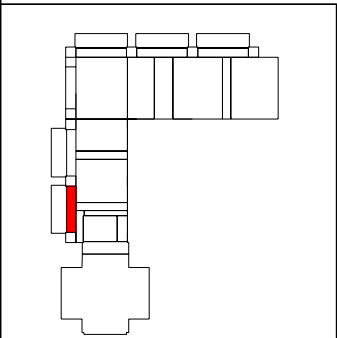
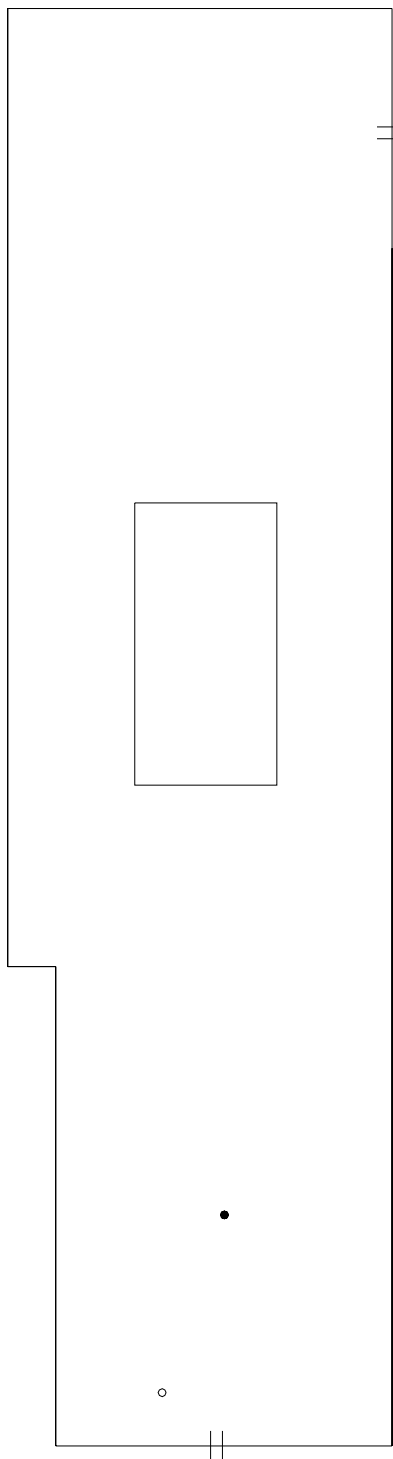

SYMBOLS KEY

- ROOF DRAIN
- ROOF CURB
- ⦶ THROUGH CURB OVERFLOW SCUPPER
- VENT STACK
- ① DEFECT-NO REPAIR

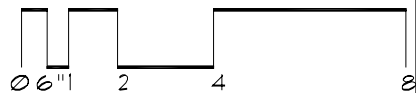

Roof Corrective Action

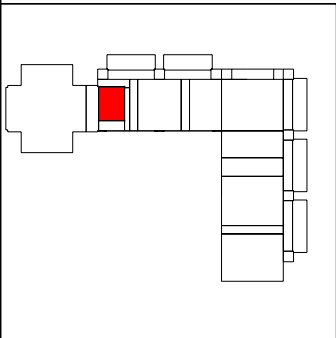
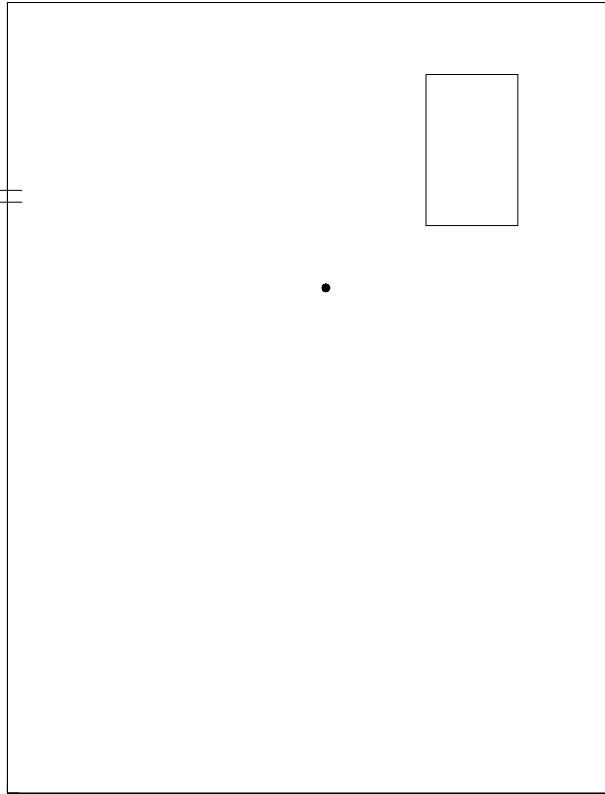

- SYMBOLS KEY
- ROOF DRAIN
 - ROOF CURB
 - ≡ SCUPPER

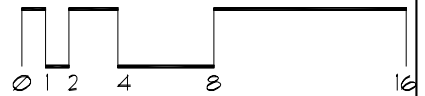

Roof Corrective Action

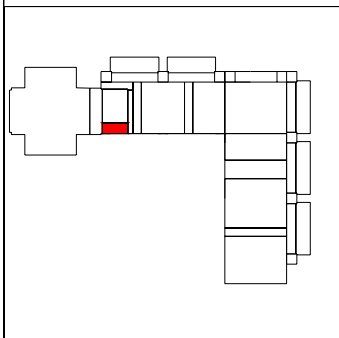

SYMBOLS KEY

- ROOF DRAIN
- ROOF CURB
- ≡ THROUGH CJ OVERFLOW SCUPPER
- ⓪ DEFECT-NO REPAIR

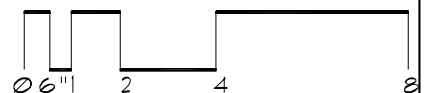

Roof Corrective Action

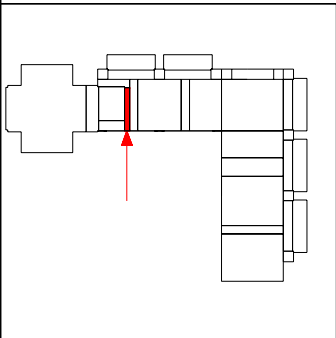
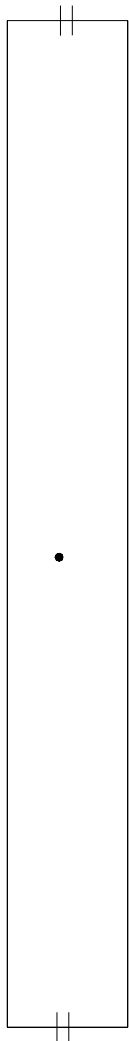

SYMBOLS KEY

- ROOF DRAIN
- || THROUGH CJ OVERFLOW SCUPPER

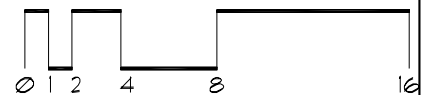

Roof Corrective Action

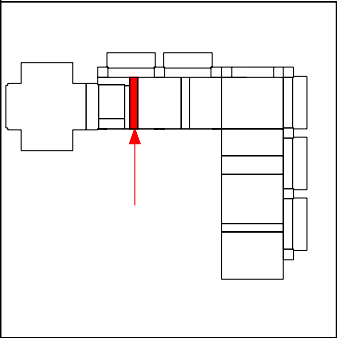
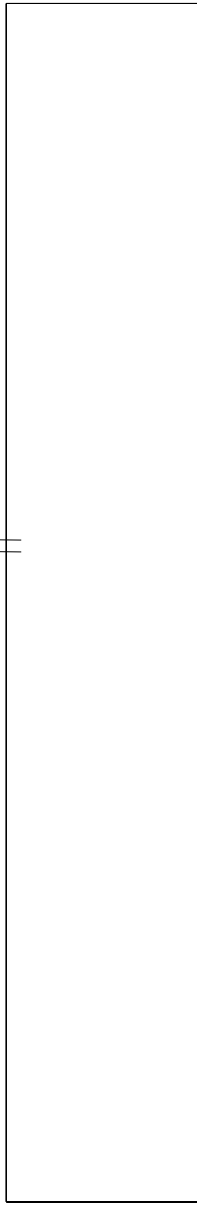

SYMBOLS KEY
|| SCUPPER

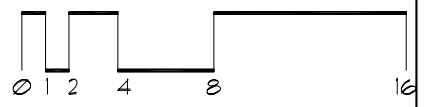
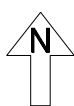

Roof Corrective Action

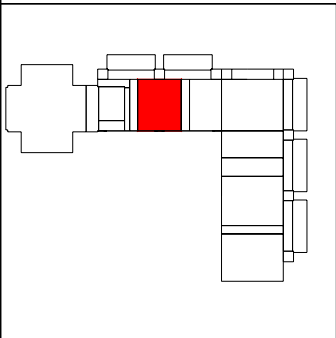
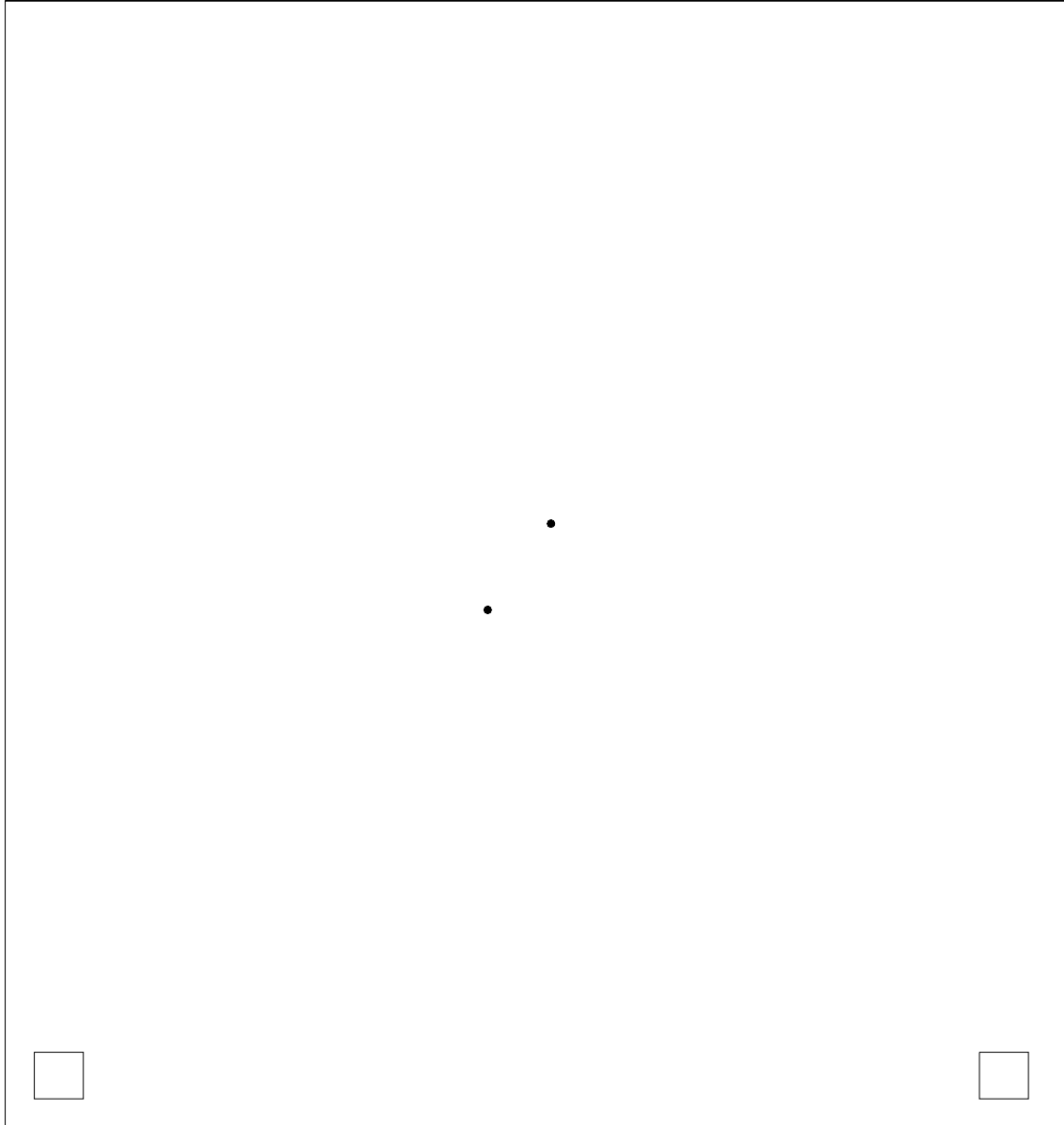

SYMBOLS KEY
● ROOF DRAIN
□ ROOF CURB

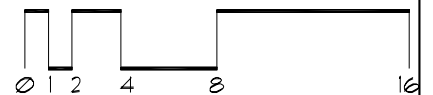

Roof Corrective Action

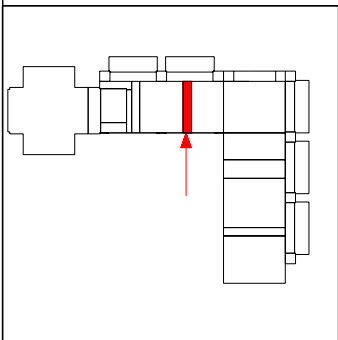
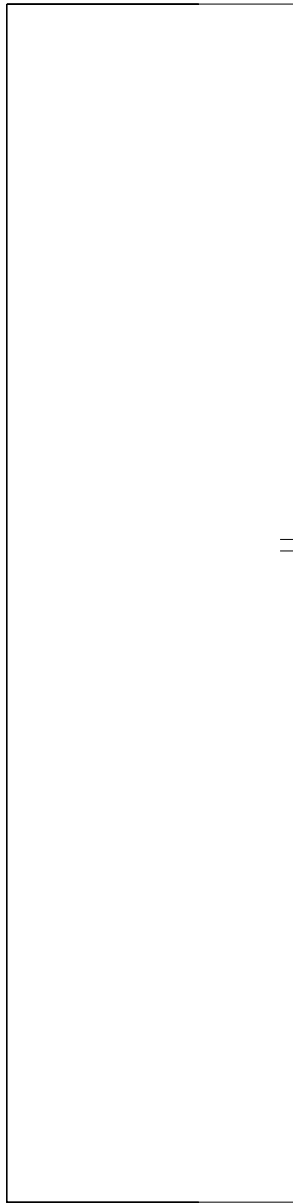

SYMBOLS KEY
|| SCUPPER

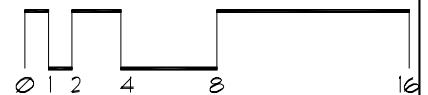

Roof Corrective Action

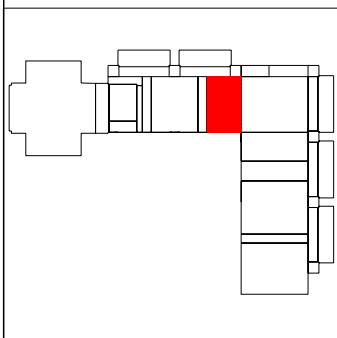
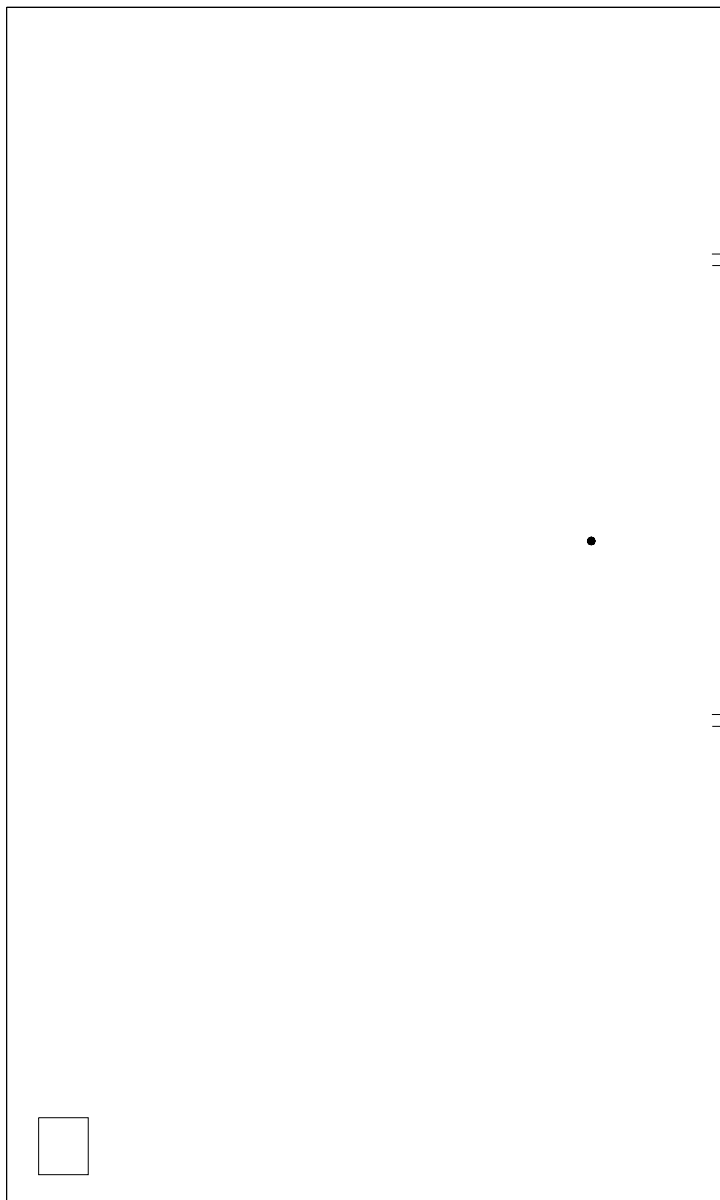

SYMBOLS KEY

- ROOF DRAIN
- ROOF CURB
- †† THROUGH CJ OVERFLOW SCUPPER

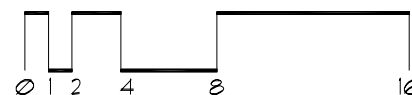

Roof Corrective Action

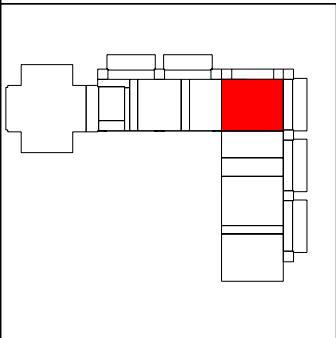
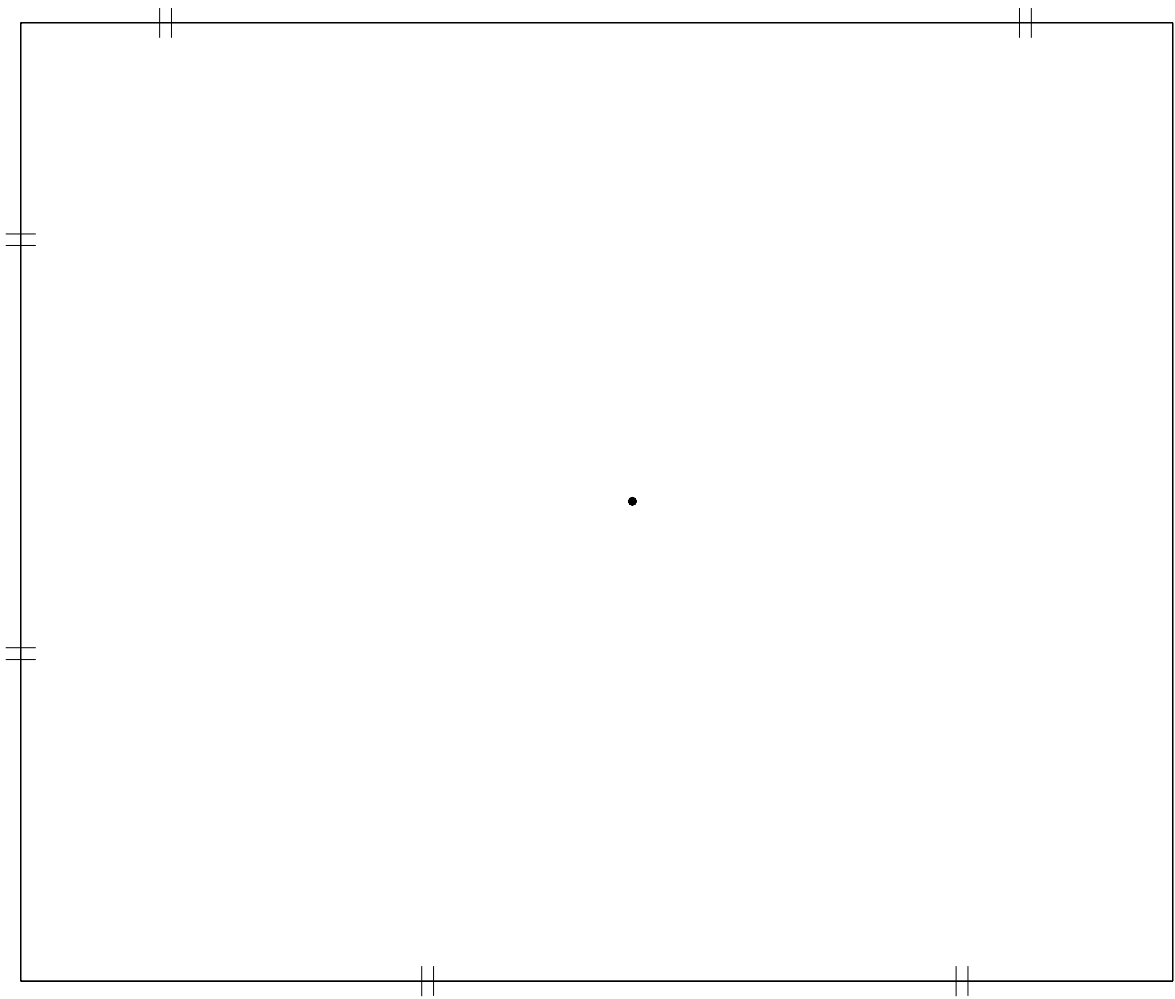

SYMBOLS KEY

- ROOF DRAIN
- || THROUGH CJ OVERFLOW SCUPPER

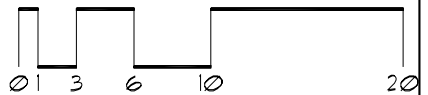

Roof Corrective Action

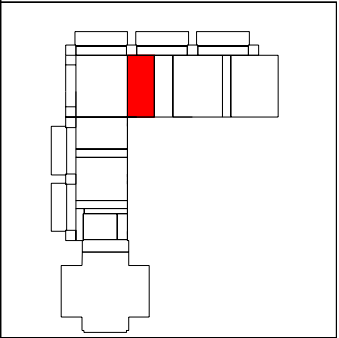
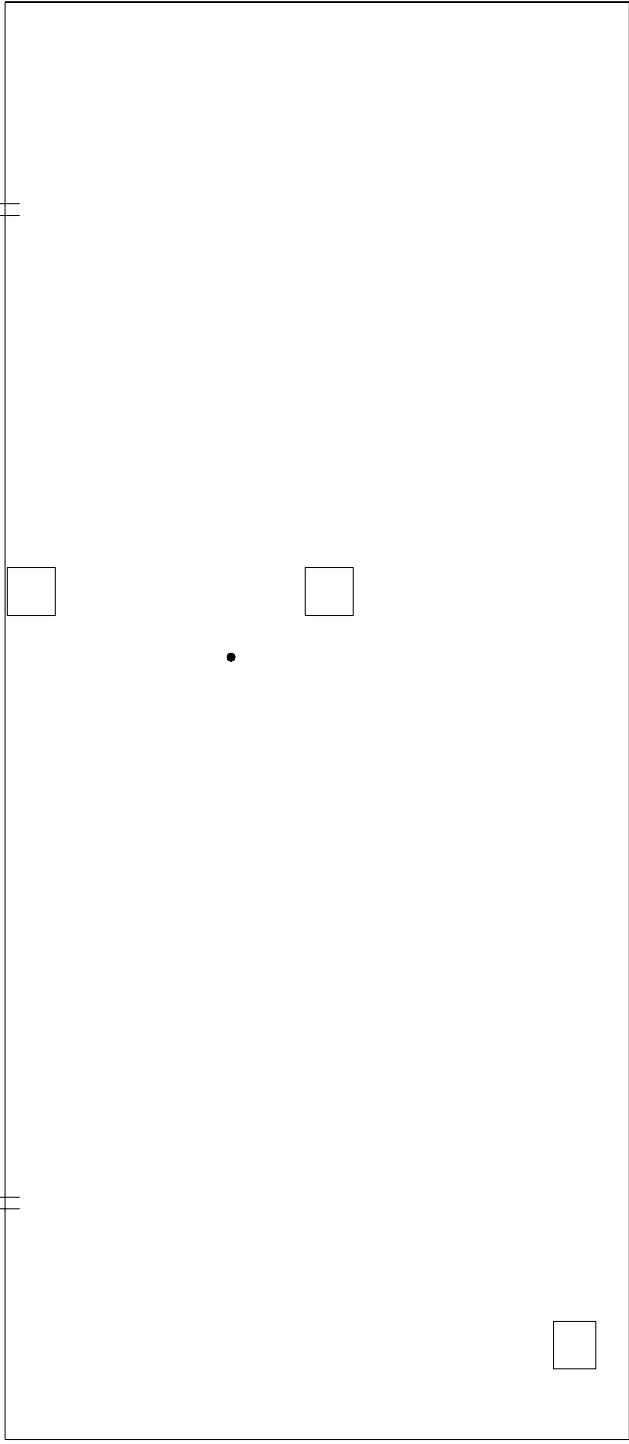

SYMBOLS KEY

- ROOF DRAIN
- ROOF CURB
- †† THROUGH CJ OVERFLOW SCUPPER

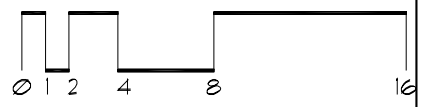

Roof Corrective Action

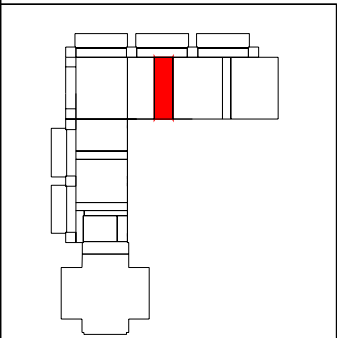
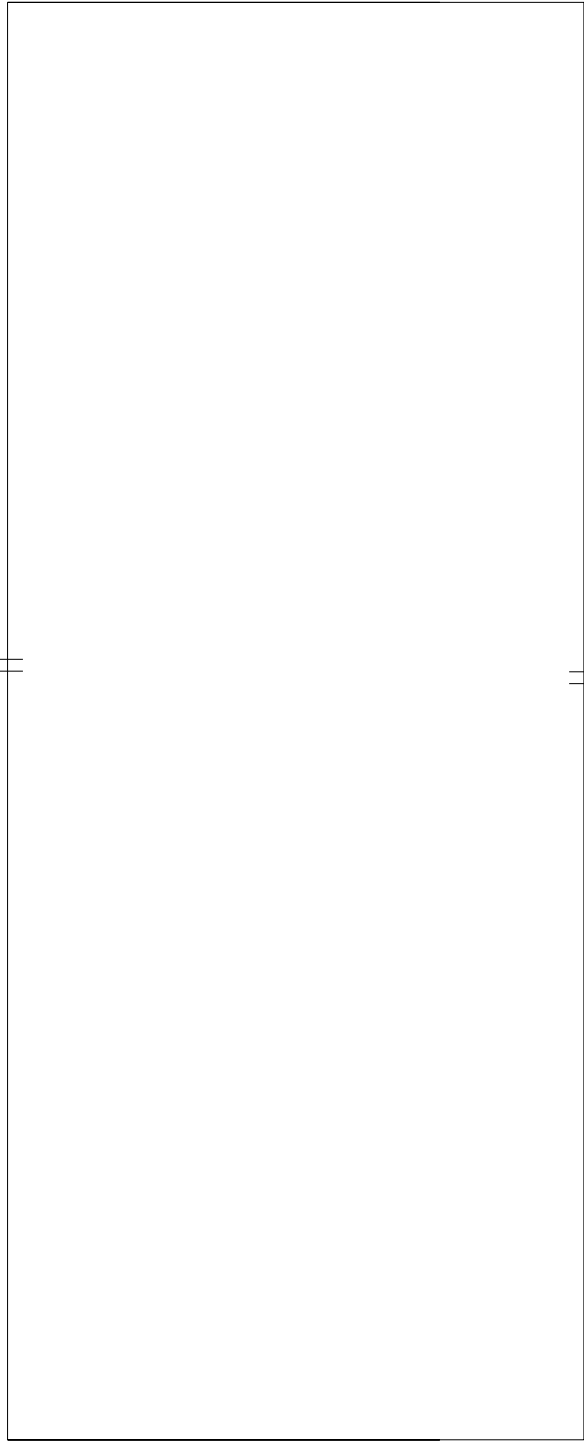

SYMBOLS KEY
|| SCUPPER

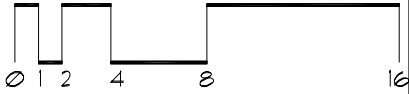

Roof Corrective Action

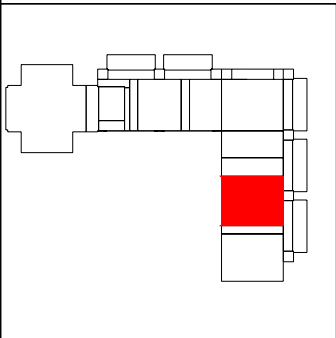
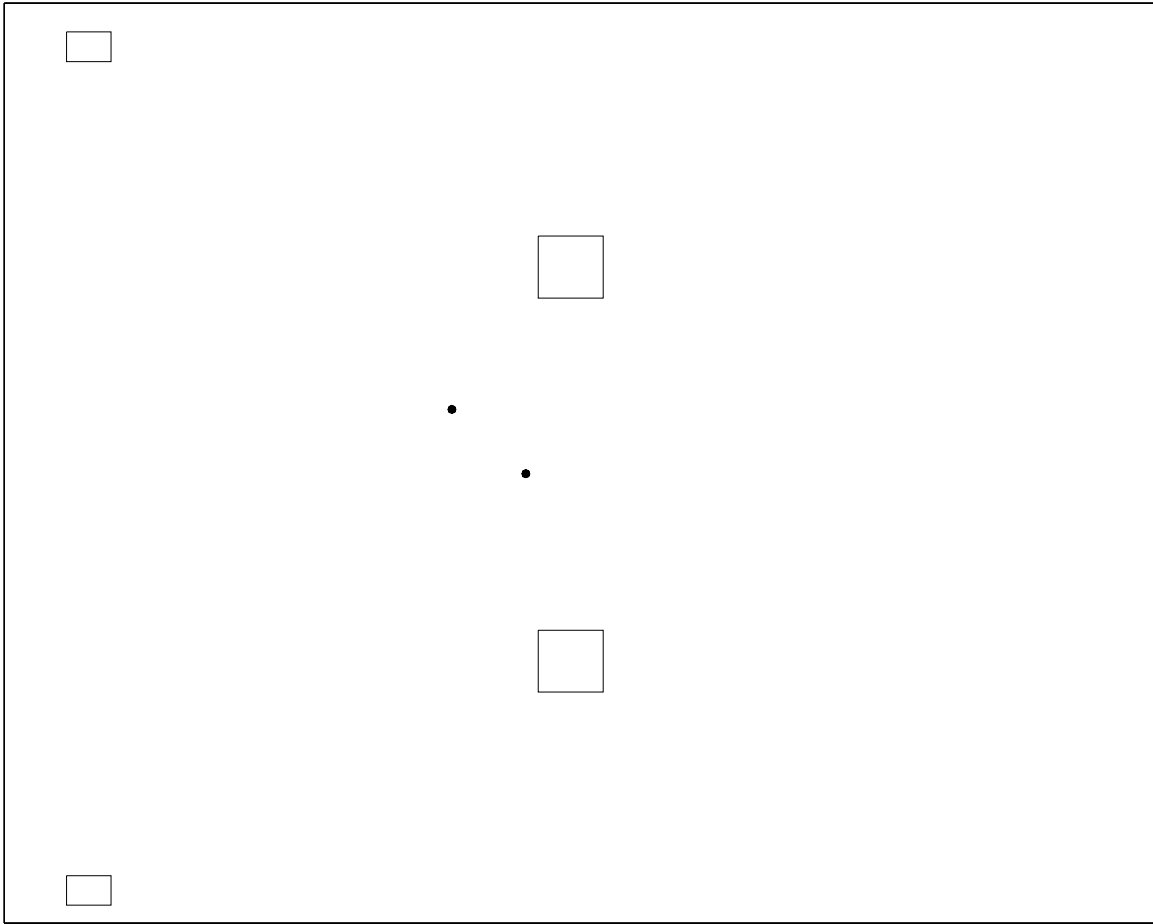

SYMBOLS KEY
● ROOF DRAIN
□ ROOF CURB

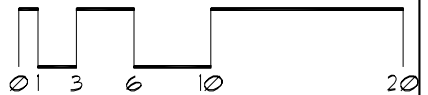

Roof Corrective Action

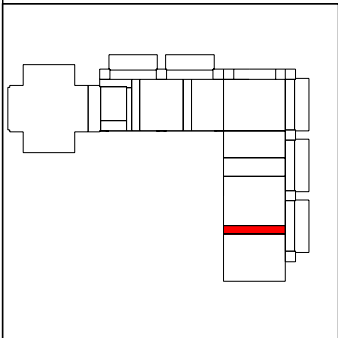
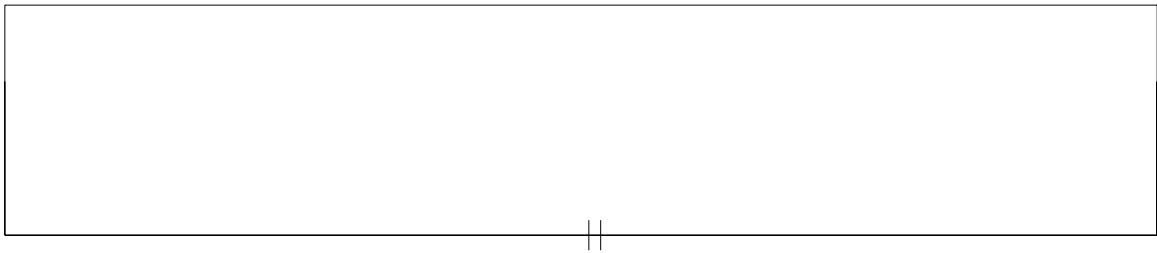

SYMBOLS KEY
|| SCUPPER

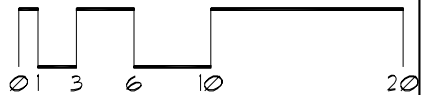

Roof Corrective Action

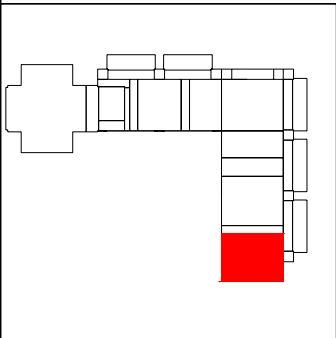
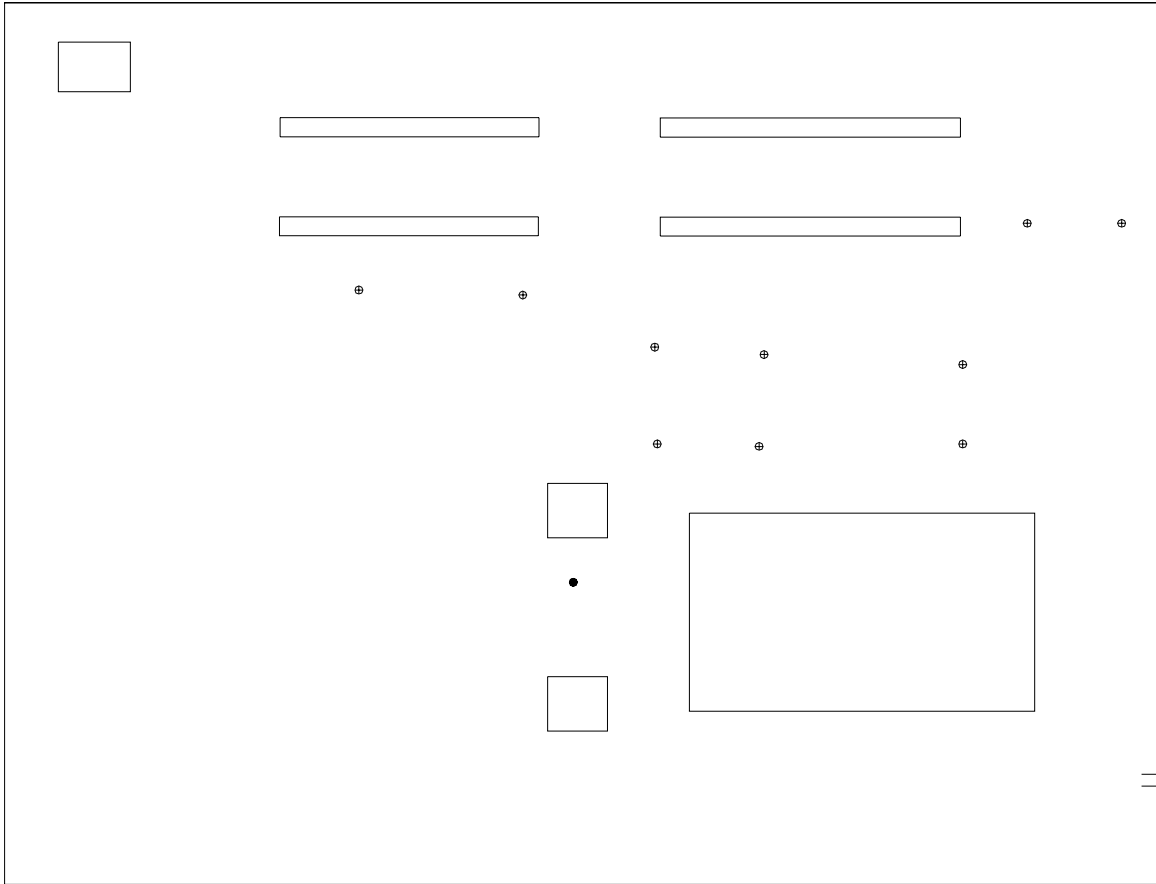

- SYMBOLS KEY**
- ROOF DRAIN
 - ROOF CURB
 - ▤ SLEEPER CURB
 - ⊕ PIPE PENETRATION

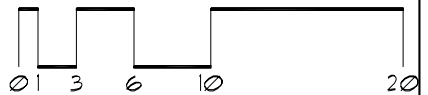

Roof Corrective Action

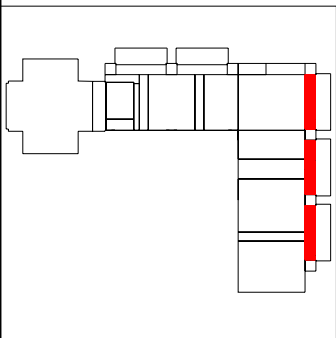
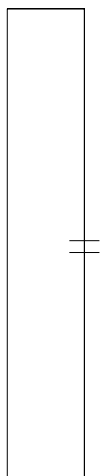
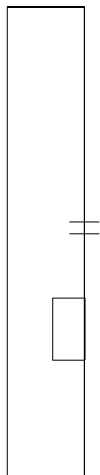
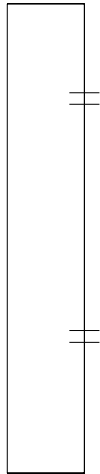

SYMBOLS KEY	
□	ROOF CURB
≡	SCUPPER

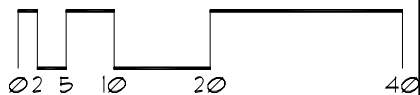
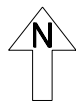

Roof Corrective Action

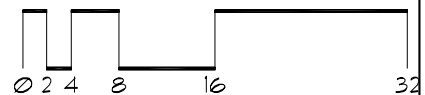
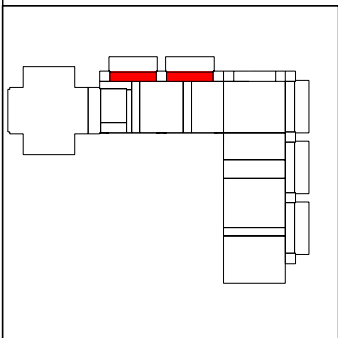
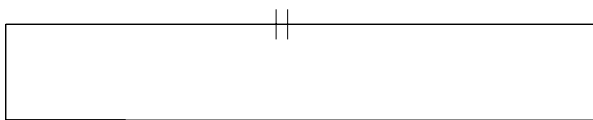

Roof Corrective Action

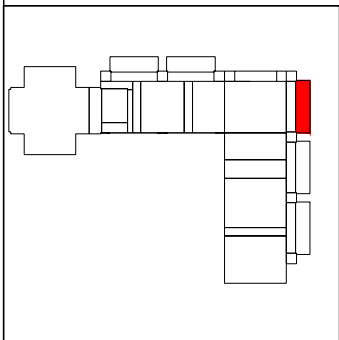
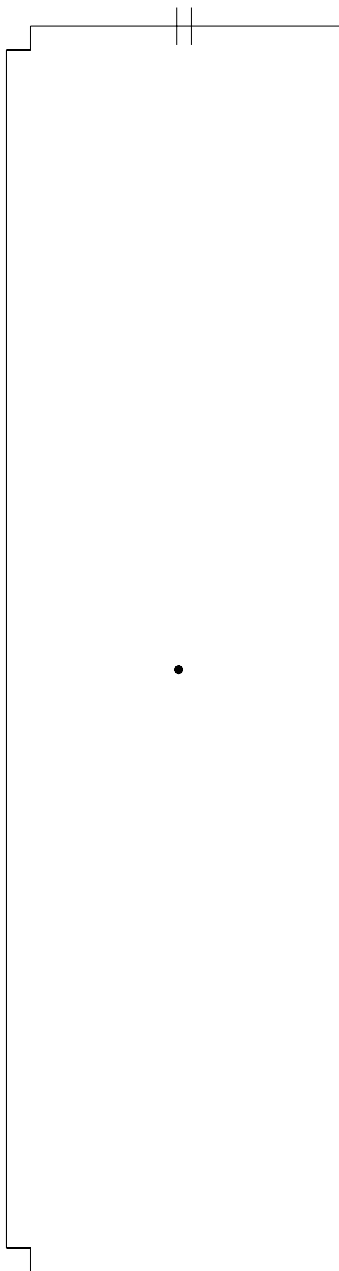

SYMBOLS KEY
• ROOF DRAIN
|| SCUPPER

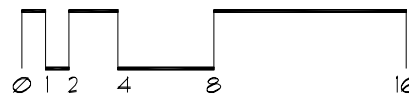

Roof Corrective Action

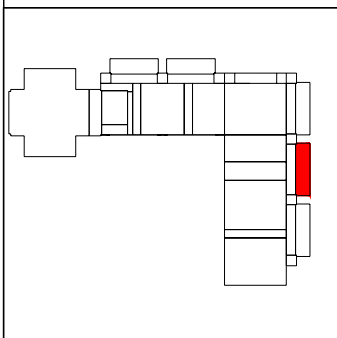
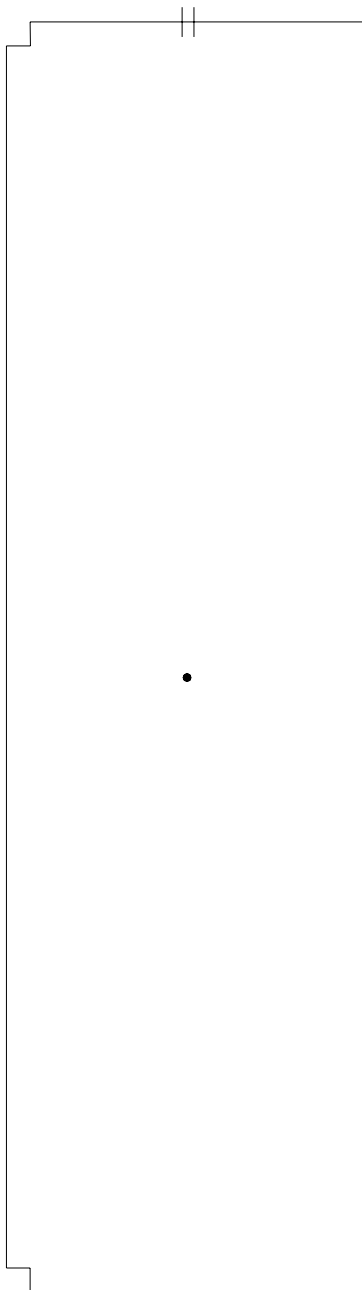

SYMBOLS KEY
● ROOF DRAIN
|| SCUPPER

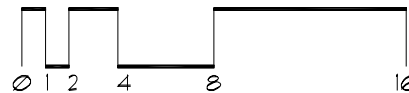

Roof Corrective Action

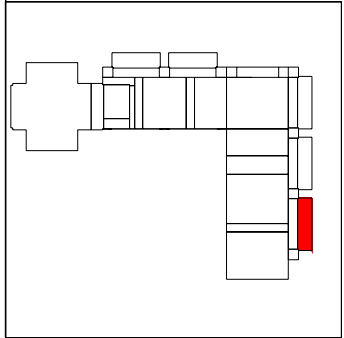
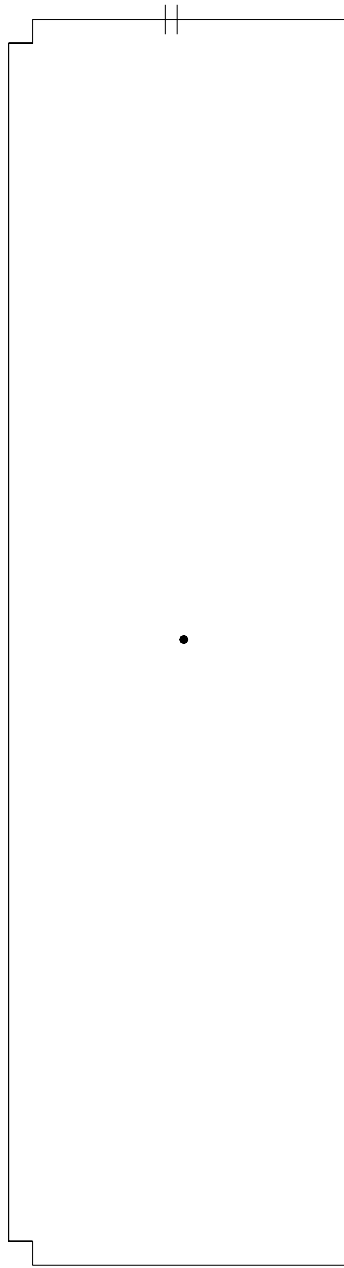

SYMBOLS KEY
|| SCUPPER
• ROOF DRAIN

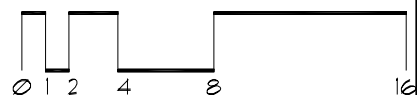

Roof Corrective Action

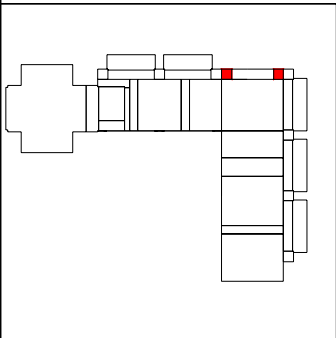
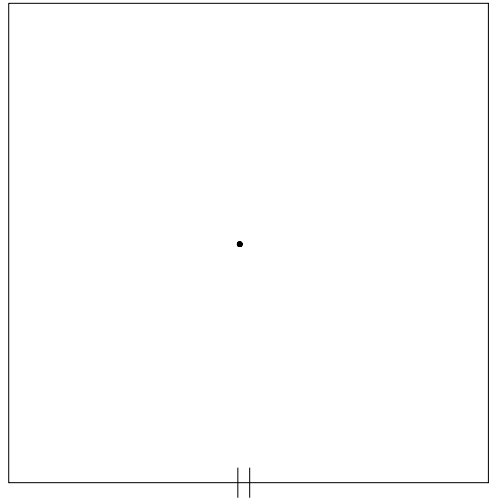
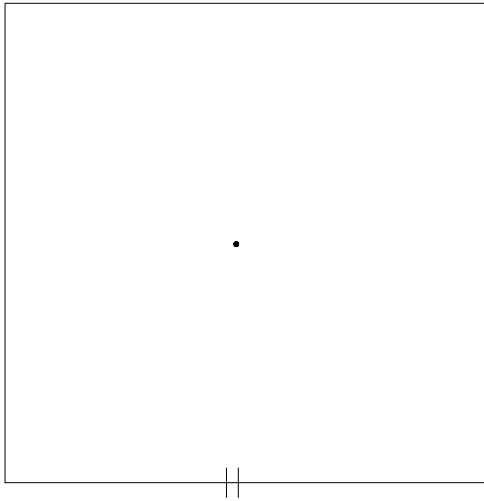

SYMBOLS KEY

- ROOF DRAIN
- || THROUGH CJ OVERFLOW SCUPPER

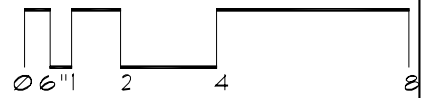

Roof Corrective Action

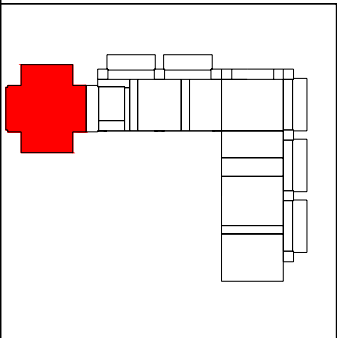
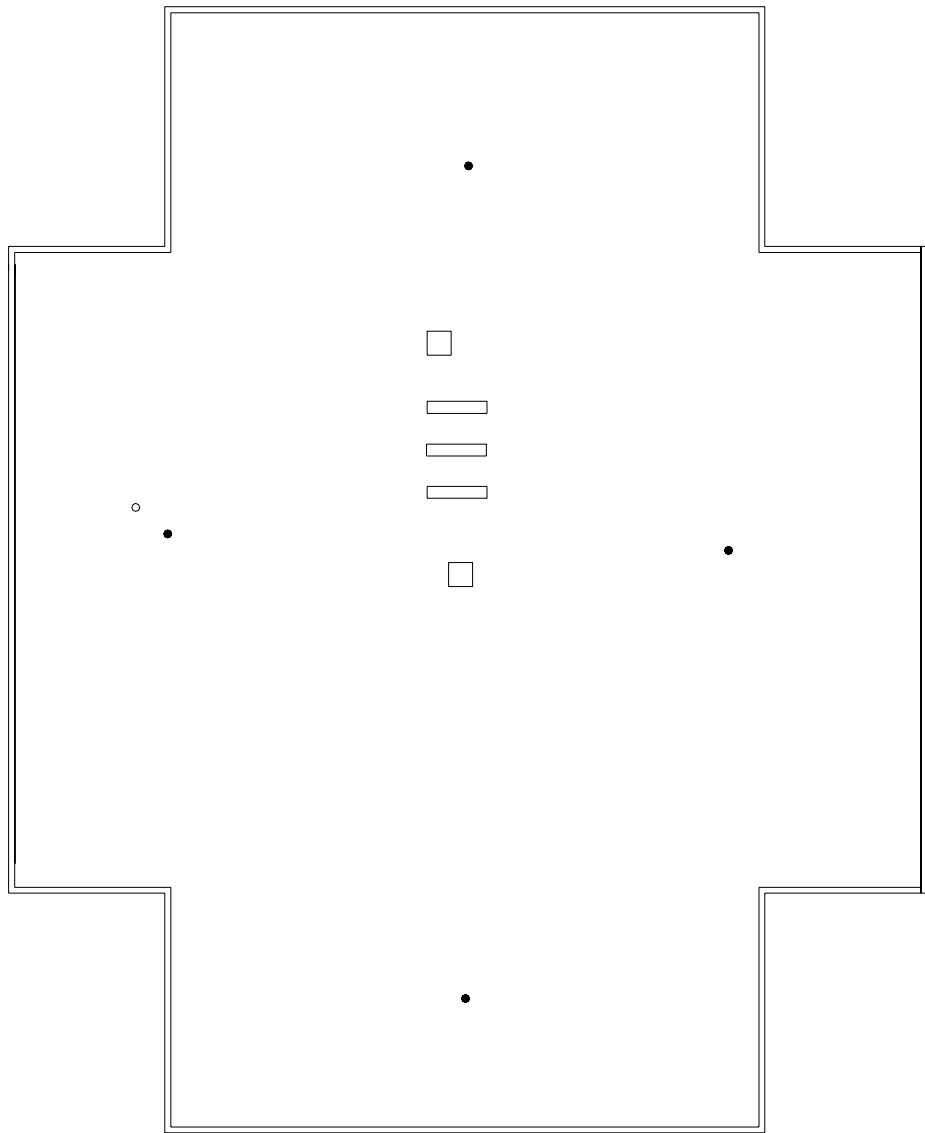

- SYMBOLS KEY**
- VENT STACK
 - ROOF DRAIN
 - ROOF CURB
 - ≡ SLEEPER CURB

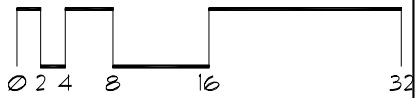

Roof ID

Building: HS143 - Dwan Variety Club - (425 East River Road Minneapolis)

Roof Access: Elevator at SW entrance to 7th floor-penthouse door at top of stairs

Total Area: 19,401 sf

A	944 sf	E	2,468 sf	I	2,200 sf	M	332 sf
B	168 sf	F	110 sf	J	9,115 sf	N	30 sf
C	944 sf	G	110 sf	K	440 sf	O	26 sf
D	144 sf	H	2,200 sf	L	170 sf		

SYMBOLS KEY

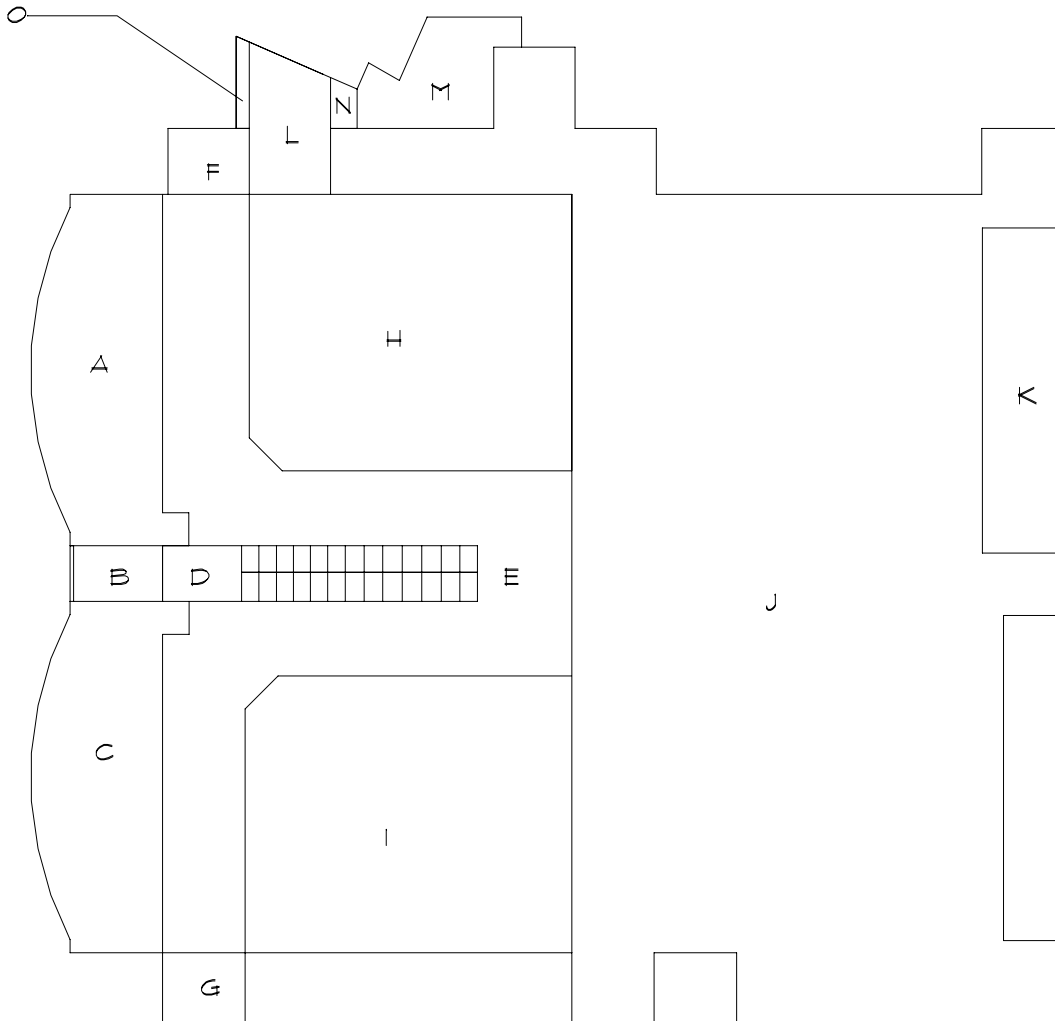

Roof Corrective Action

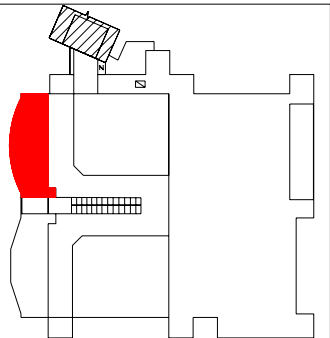
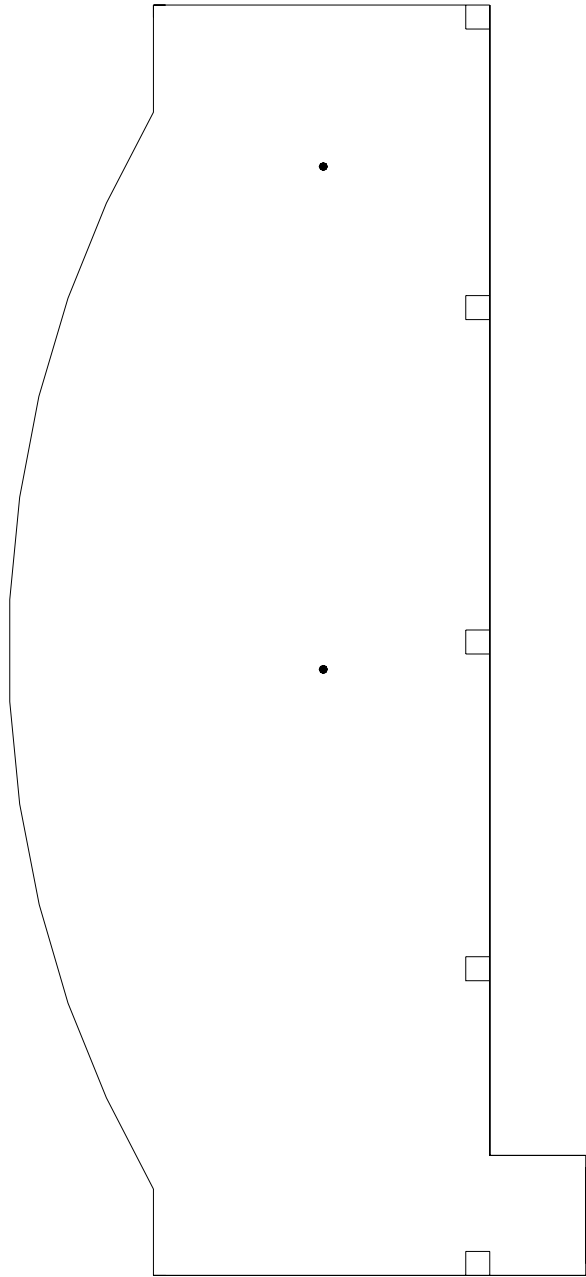

- SYMBOLS KEY**
- ROOF DRAIN
 - ROOF CURB
 - Ⓢ DEFECT-REPAIR

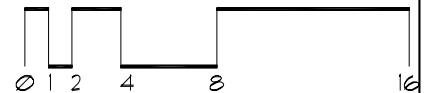

Roof Corrective Action

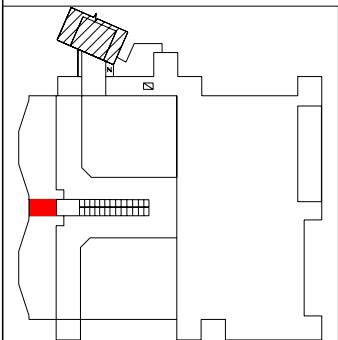
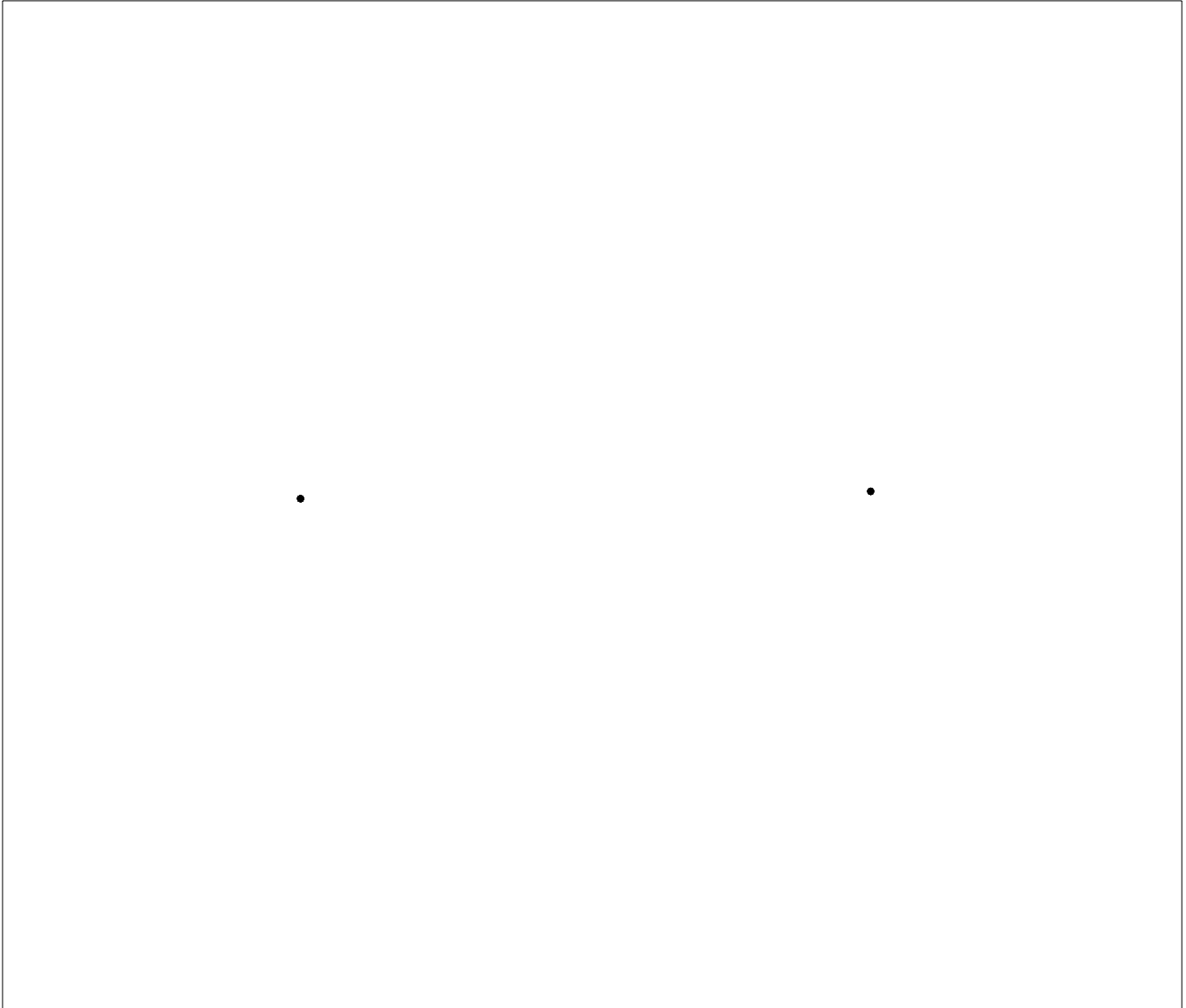

SYMBOLS KEY
• ROOF DRAIN

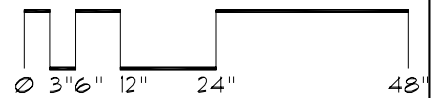

Roof Corrective Action

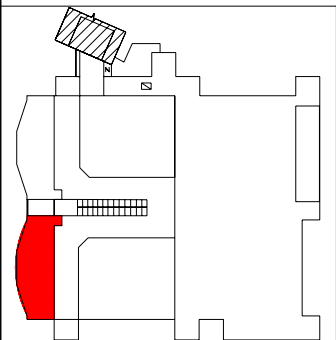
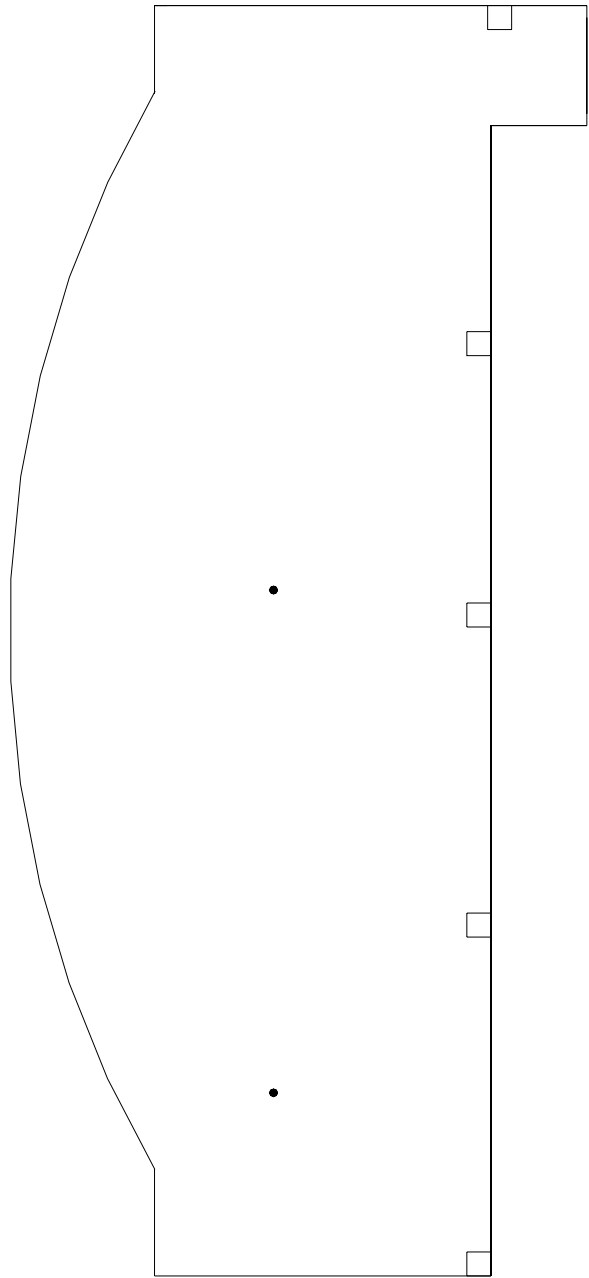

SYMBOLS KEY

- ROOF DRAIN
- Ⓢ DEFECT-REPAIR
- Ⓣ DEFECT-NO REPAIR

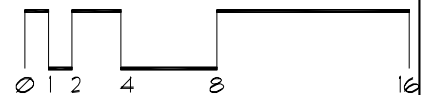

Roof Corrective Action

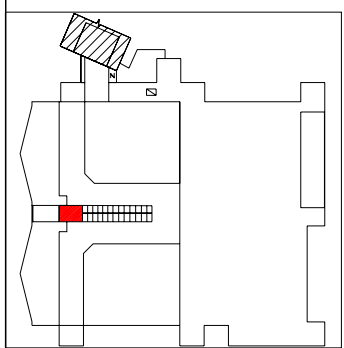
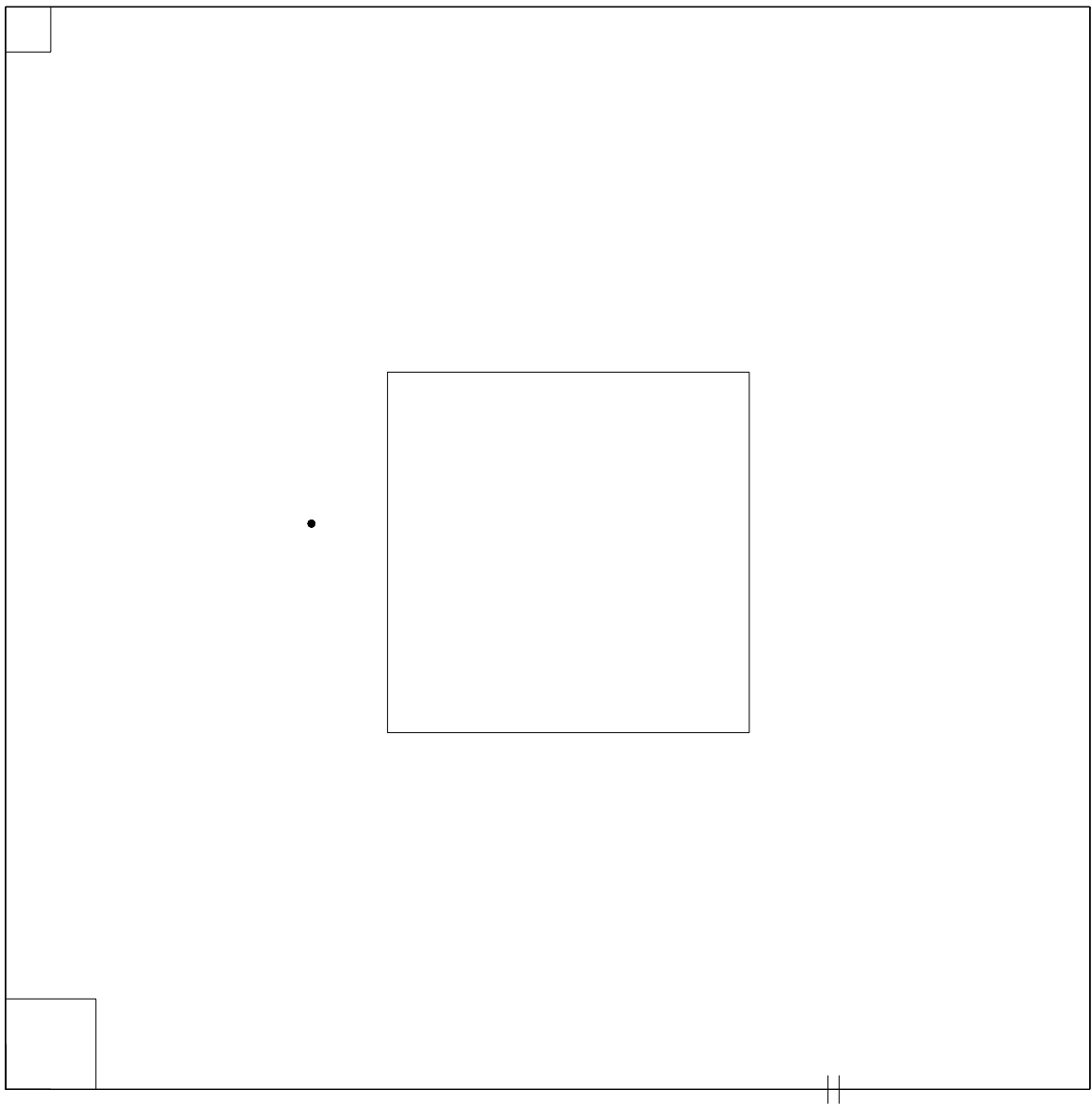

- SYMBOLS KEY**
- ROOF DRAIN
 - ROOF CURB
 - ≡ SCUPPER

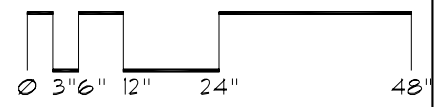
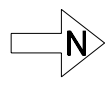

Roof Corrective Action

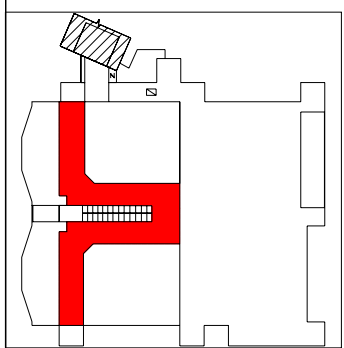
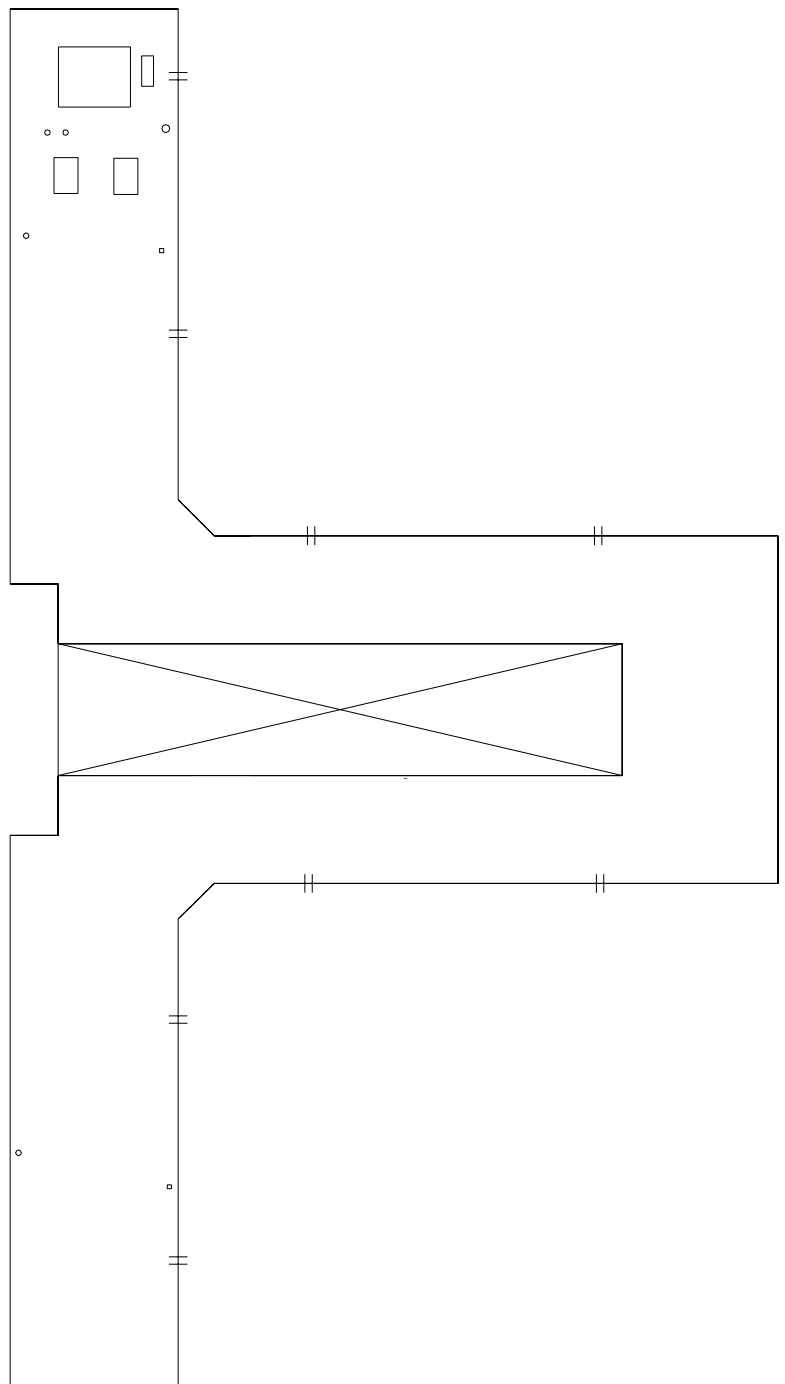

SYMBOLS KEY

⊥	SCUPPER
□	ROOF CURB
Ⓢ	DEFECT-REPAIR

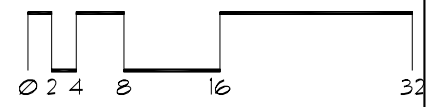
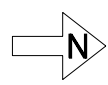

Roof Corrective Action

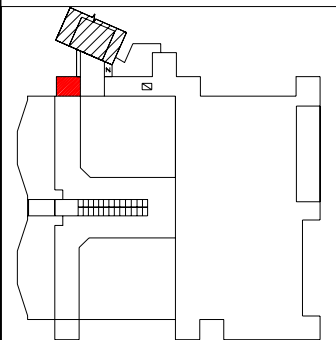
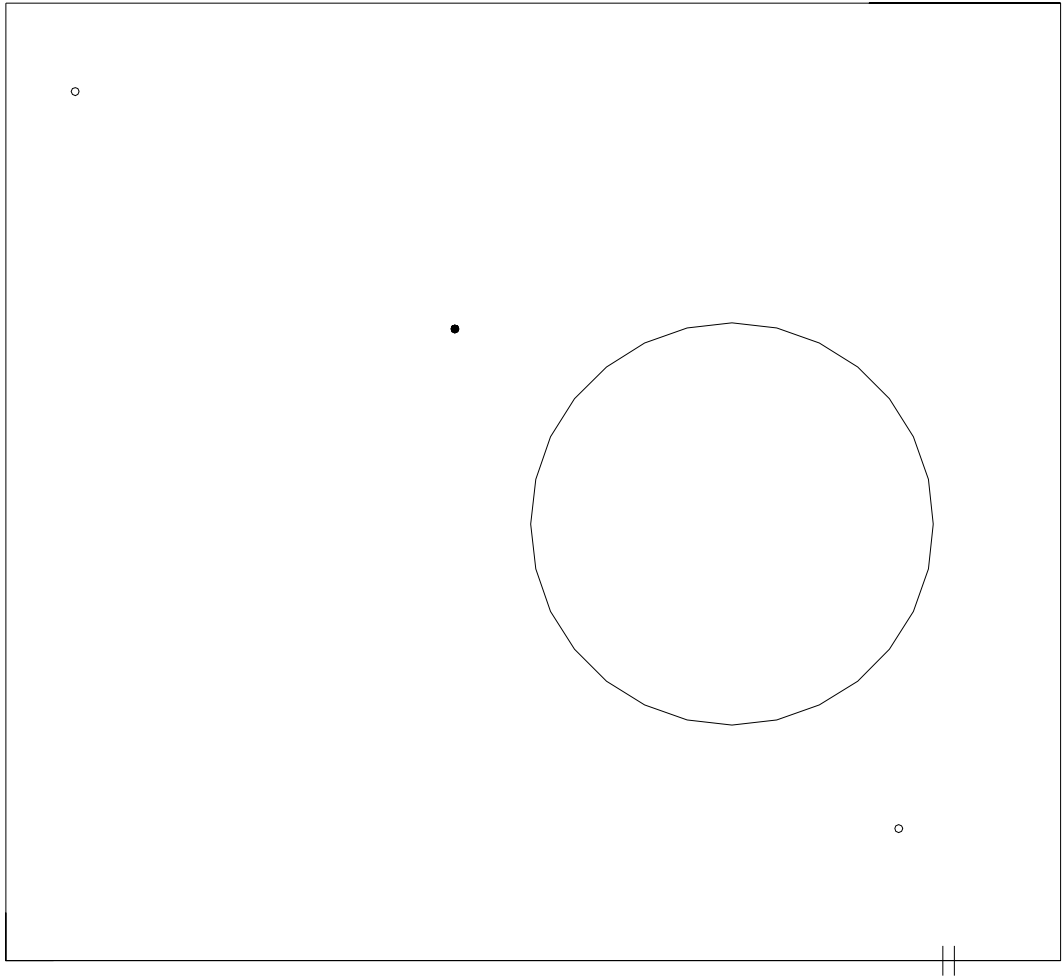

SYMBOLS KEY
○ VENT STACK
● ROOF DRAIN

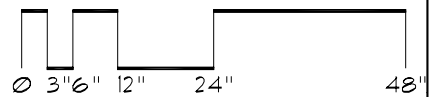
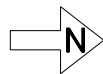

Roof Corrective Action

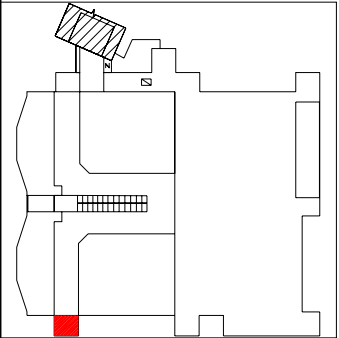
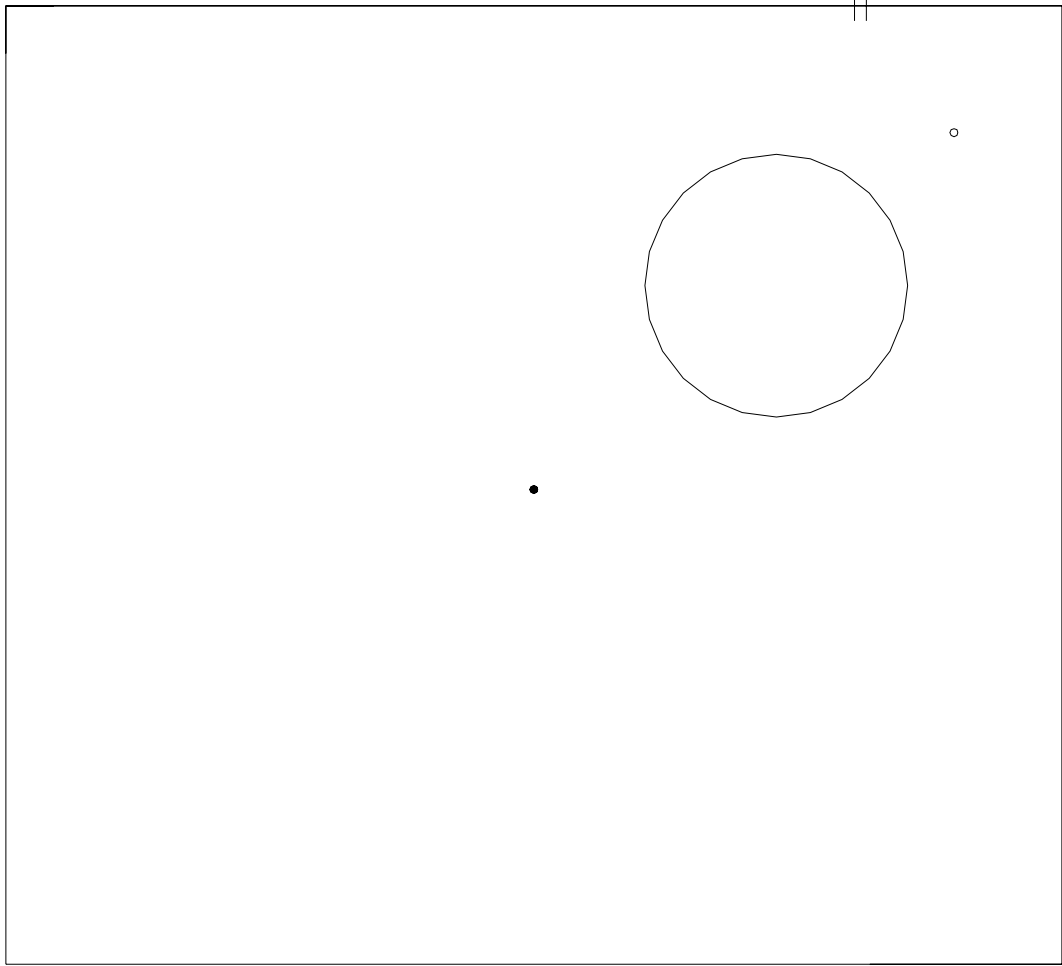

SYMBOLS KEY
|| SCUPPER
o VENT STACK
• ROOF DRAIN

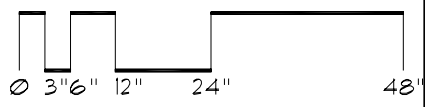

Roof Corrective Action

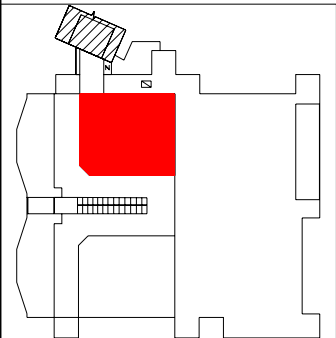
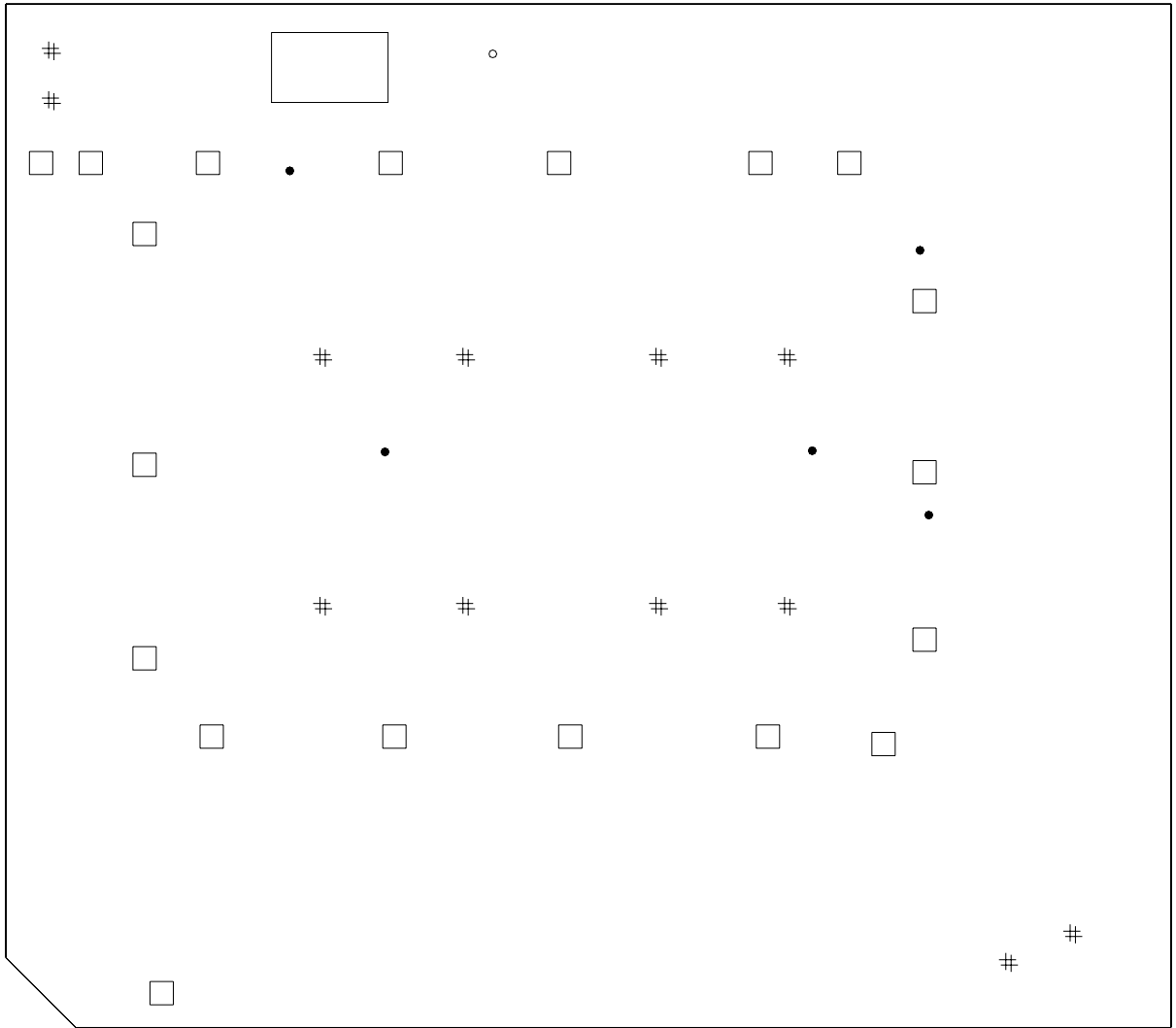

- SYMBOLS KEY**
- VENT STACK
 - ROOF DRAIN
 - ROOF CURB
 - # DEFECT-REPAIR

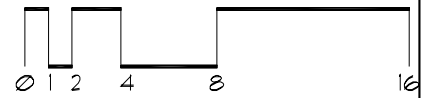

Roof Corrective Action

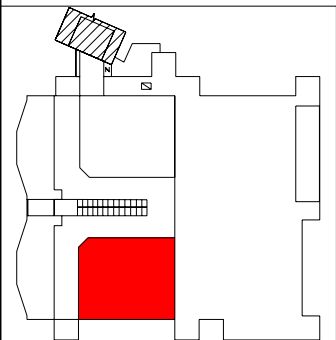

SYMBOLS KEY

- VENT STACK
- ROOF DRAIN
- ROOF CURB

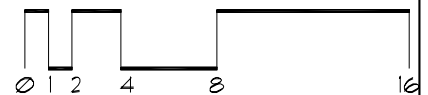

Roof Corrective Action

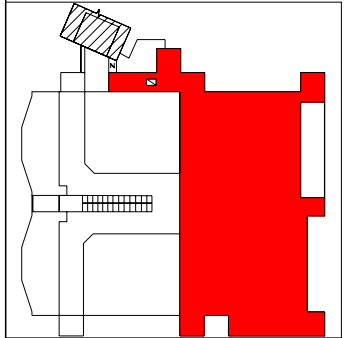

- SYMBOLS KEY**
- VENT STACK
 - ROOF DRAIN
 - ROOF CURB
 - ① DEFECT-NO REPAIR

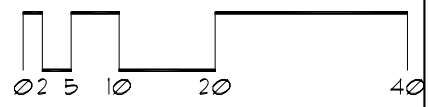
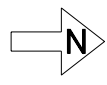

Roof Corrective Action

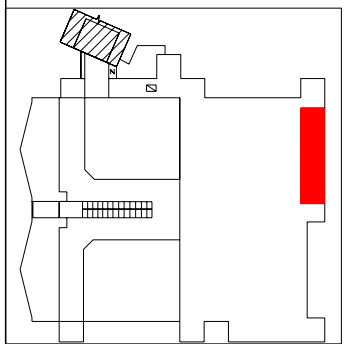
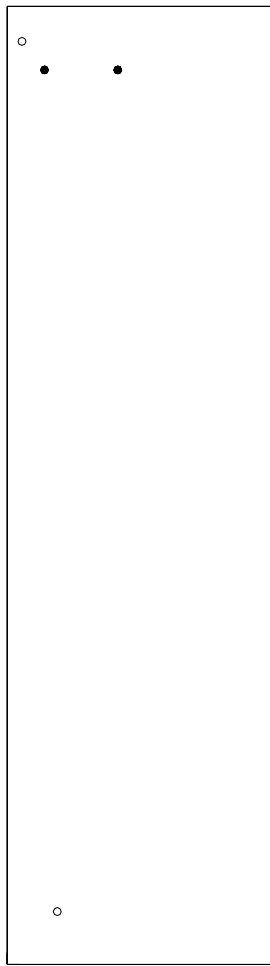

- SYMBOLS KEY**
- VENT STACK
 - ROOF DRAIN
 - Ⓢ DEFECT-REPAIR

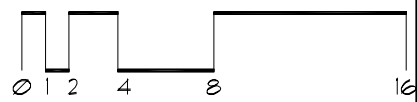

Roof Corrective Action

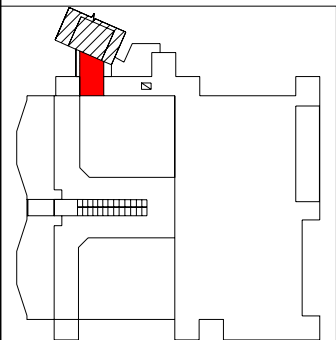
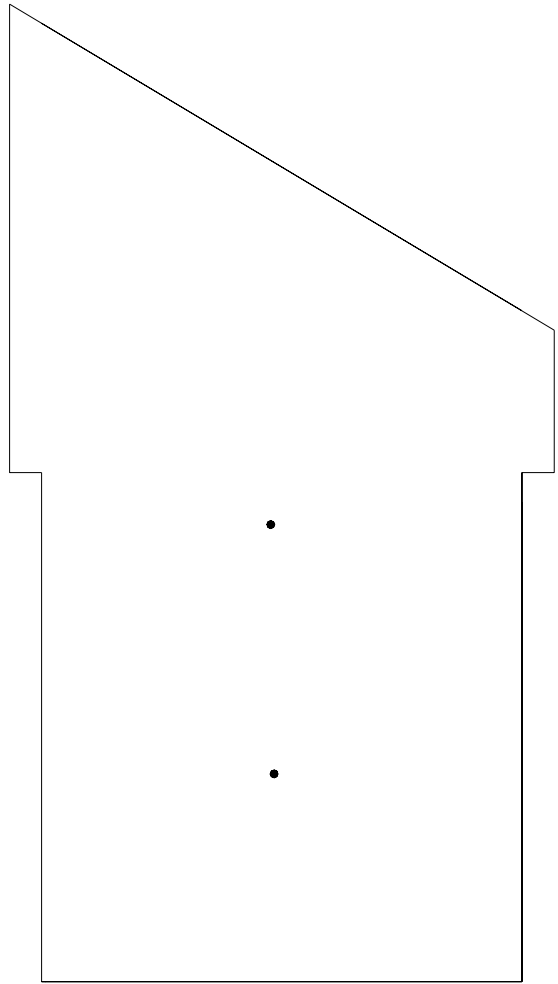

SYMBOLS KEY
• ROOF DRAIN

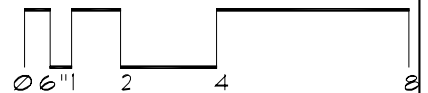

Roof Corrective Action

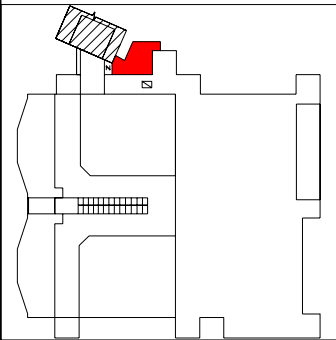
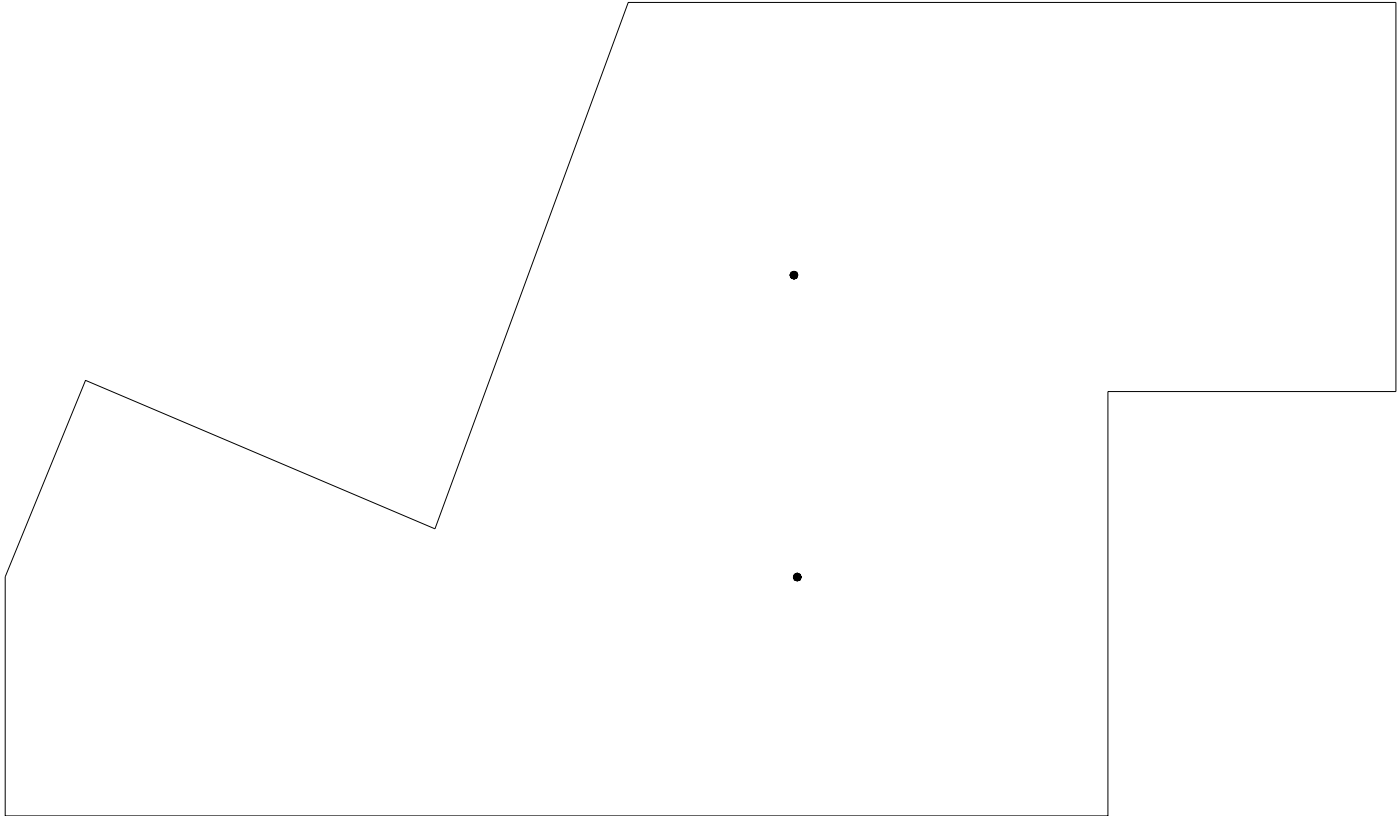

SYMBOLS KEY
• ROOF DRAIN

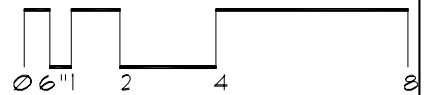

Roof Corrective Action

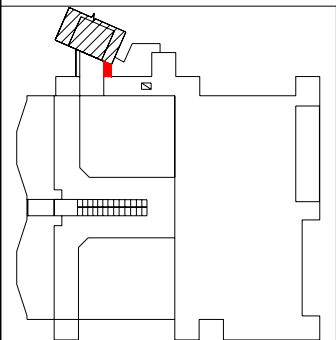
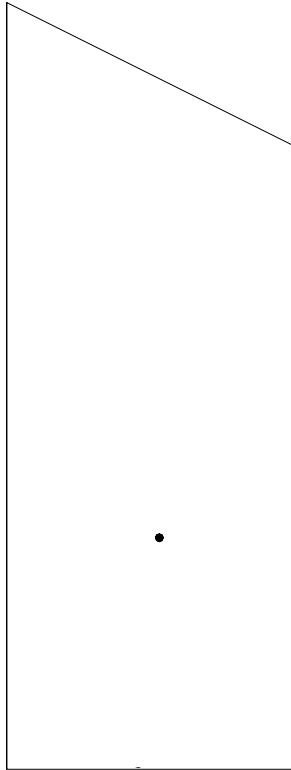

SYMBOLS KEY

- ROOF DRAIN
- ⓪ DEFECT-NO REPAIR

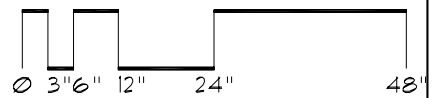
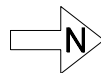

Roof Corrective Action

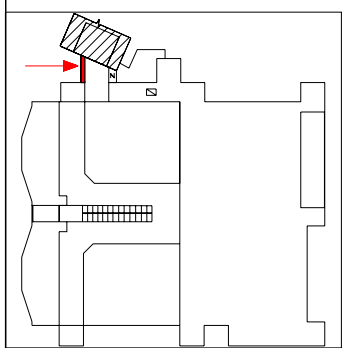
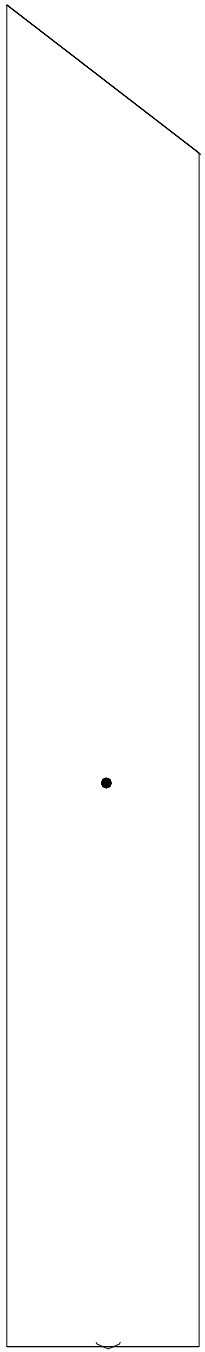

SYMBOLS KEY
● ROOF DRAIN
⓪ DEFECT-NO REPAIR

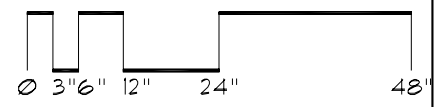
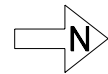

Roof ID

Building: HS144 - Phillips-Wangensteen - (516 Delaware Street SE Minneapolis)

Roof Access: A-R=15th Floor North Stairs; S-V=10th floor North Stairs; W=4th Floor North Stairs

Total Area: 26,798 sf

A	1,328 sf	E	3,080 sf	I	144 sf	M	1,000 sf	Q	1,172 sf	U	1,512 sf
B	728 sf	F	342 sf	J	1,440 sf	N	2,100 sf	R	1,248 sf	V	600 sf
C	2,040 sf	G	836 sf	K	168 sf	O	2,000 sf	S	600 sf	W	660 sf
D	1,380 sf	H	342 sf	L	1,356 sf	P	600 sf	T	2,122 sf		

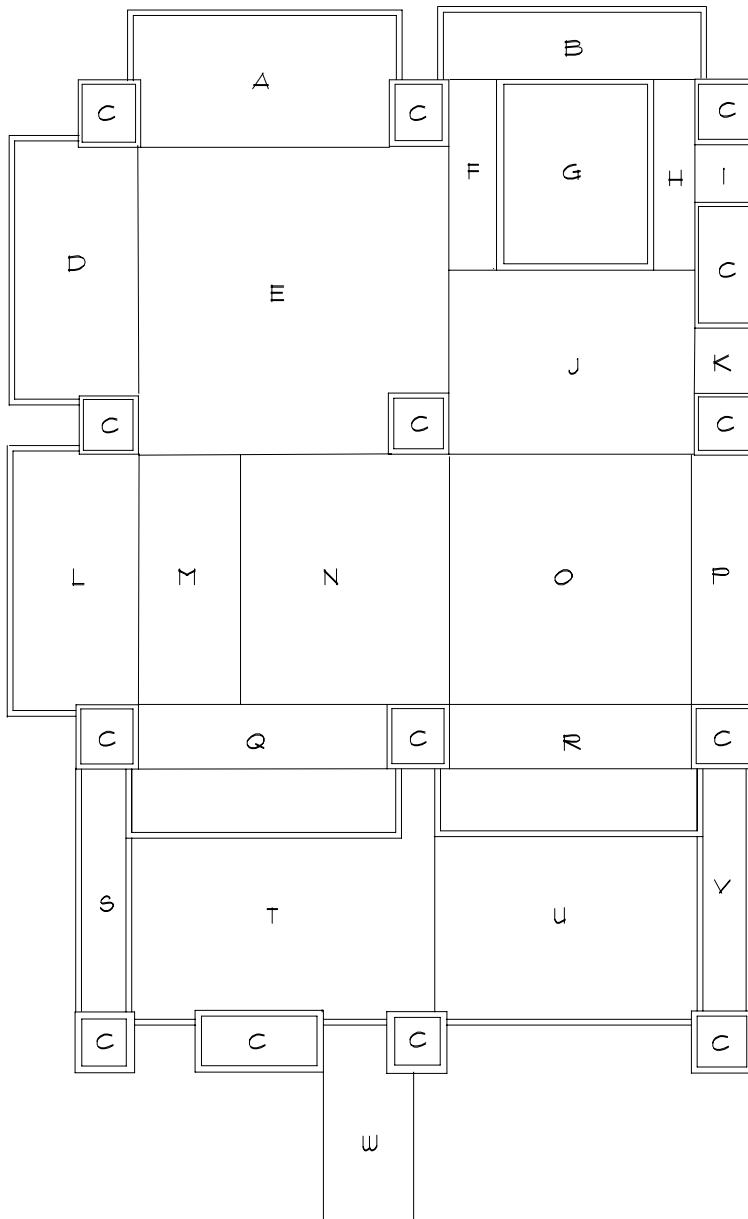

Roof Corrective Action

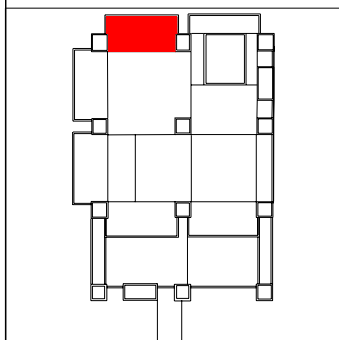
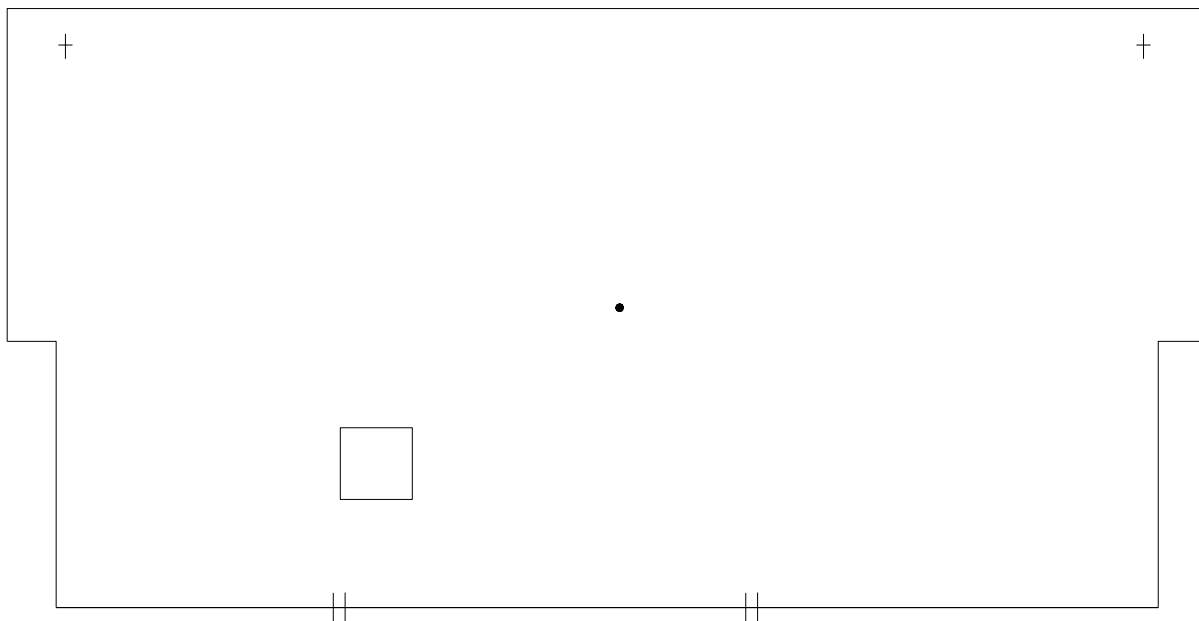

- SYMBOLS KEY**
- ROOF DRAIN
 - ROOF CURB
 - ⦶ THROUGH CJ SCUPPER
 - ⊕ LIGHTNING PROTECTION

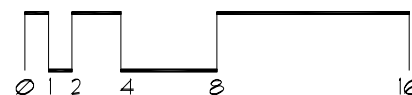
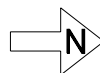

Roof Corrective Action

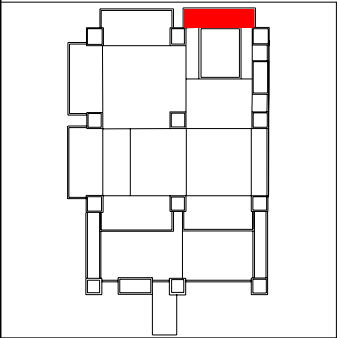
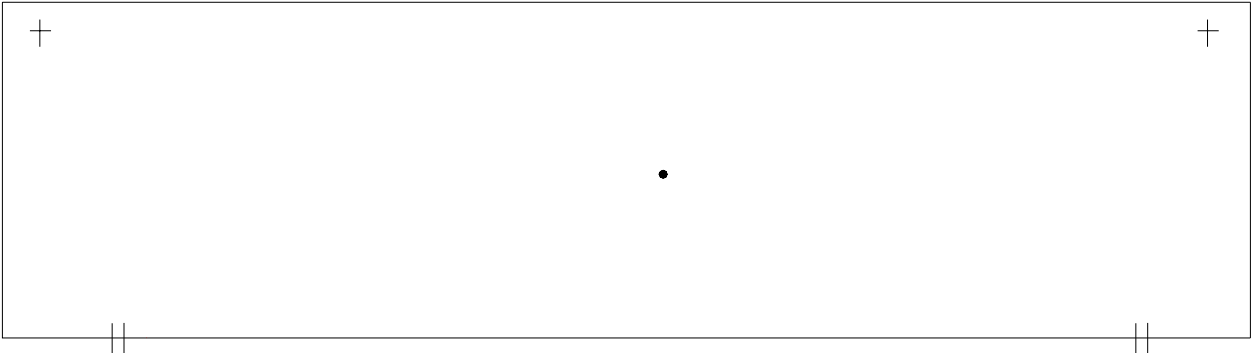

SYMBOLS KEY
• ROOF DRAIN
⦶ THROUGH CJ SCUPPER
+ LIGHTNING PROTECTION

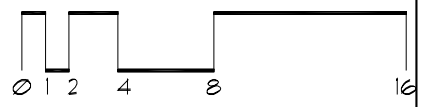
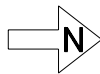

Roof Corrective Action

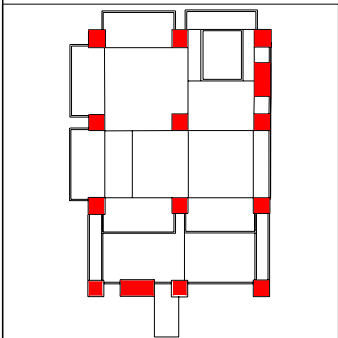
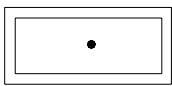
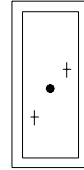

SYMBOLS KEY

- ROOF DRAIN
- ROOF CURB
- † LIGHTNING PROTECTION
- VENT STACK

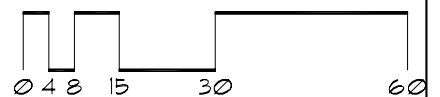

Roof Corrective Action

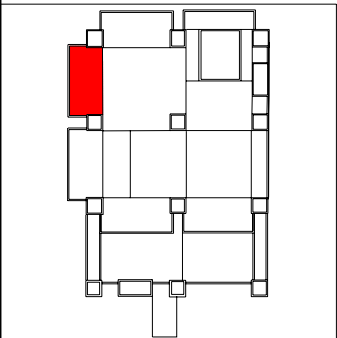
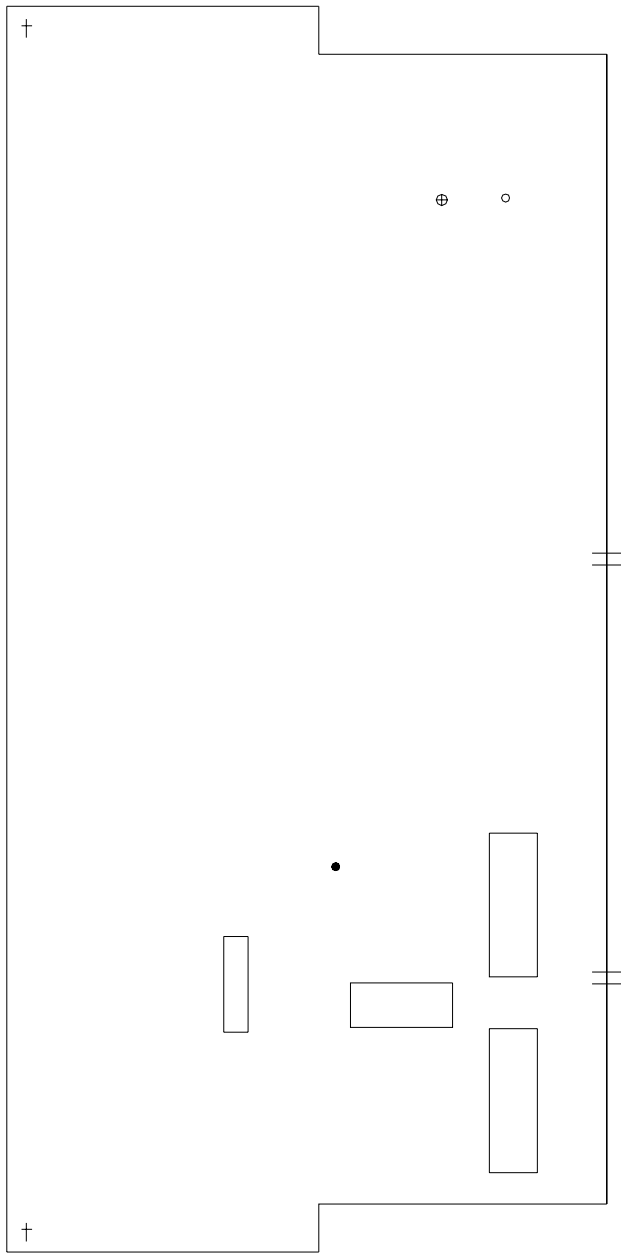

- SYMBOLS KEY**
- ROOF DRAIN
 - ROOF CURB
 - ⊕ THROUGH CJ SCUPPER
 - ⊕ LIGHTNING PROTECTION
 - ⊕ PIPE PENETRATION

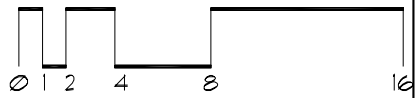

Roof Corrective Action

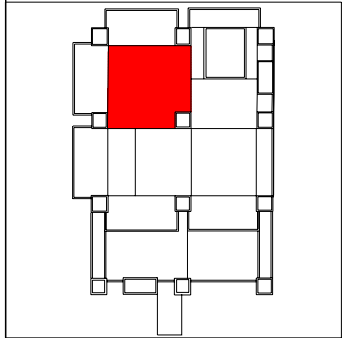
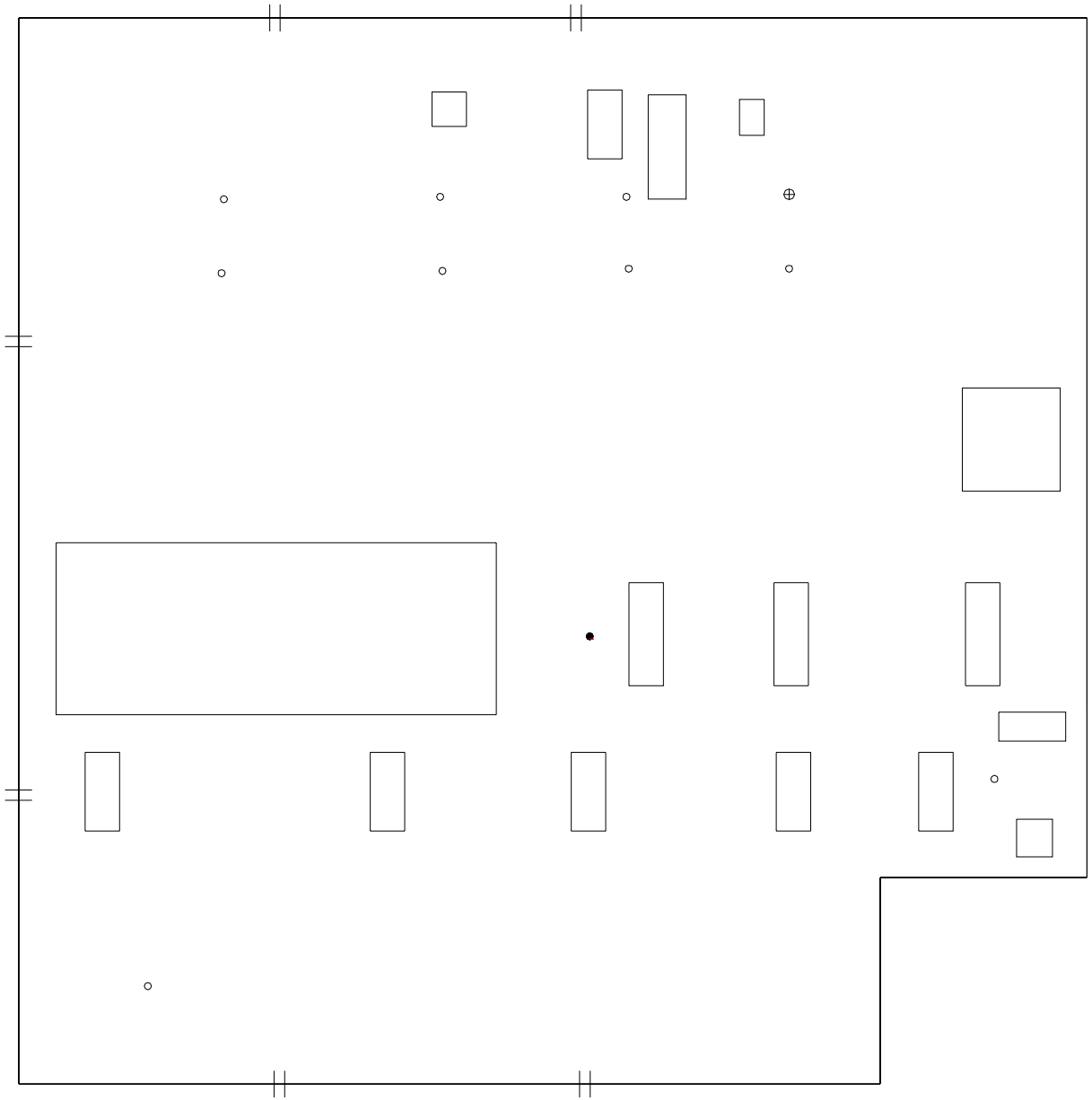

- SYMBOLS KEY**
- VENT STACK
 - ROOF DRAIN
 - ROOF CURB
 - ⦶ THROUGH CJ SCUPPER
 - ① DEFECT-NO REPAIR
 - ⊕ PIPE PENETRATION

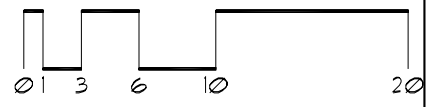
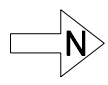

Roof Corrective Action

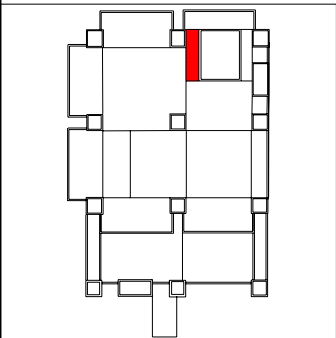
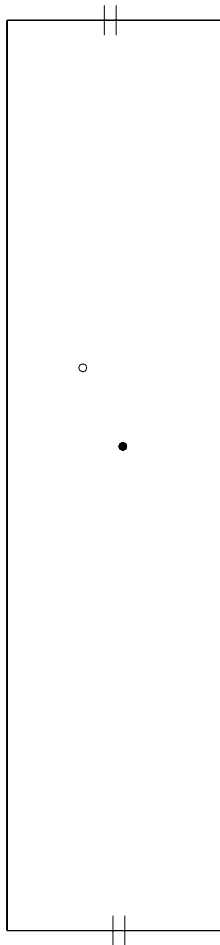

SYMBOLS KEY
○ VENT STACK
● ROOF DRAIN
⊥ THROUGH CJ SCUPPER

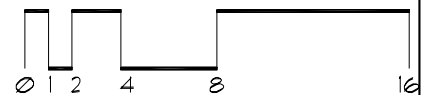

Roof Corrective Action

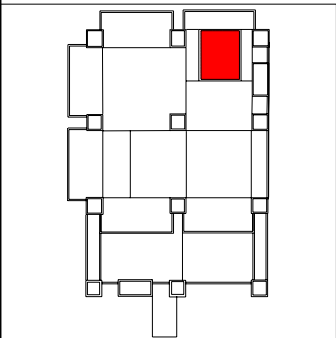
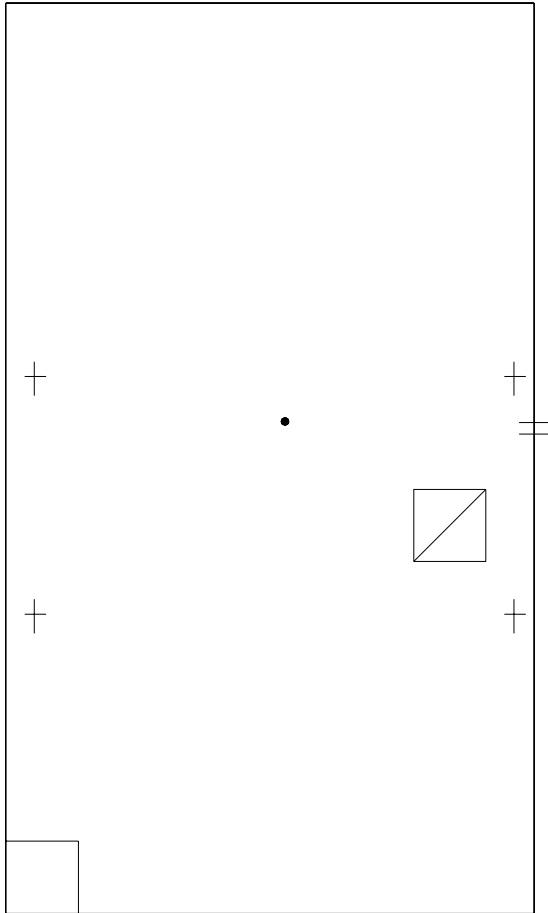

- SYMBOLS KEY**
- ROOF DRAIN
 - ROOF CURB
 - † LIGHTNING PROTECTION
 - †† SCUPPER

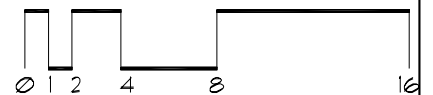

Roof Corrective Action

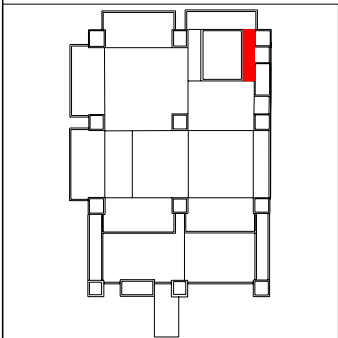
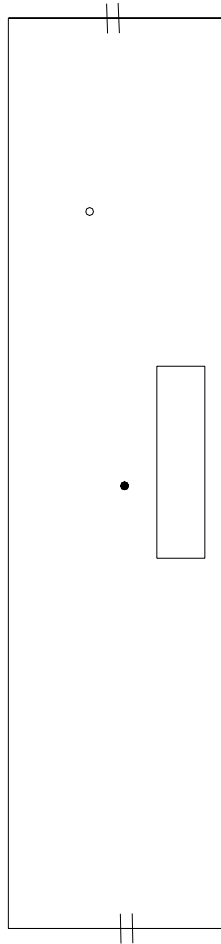

SYMBOLS KEY

- VENT STACK
- ROOF DRAIN
- ROOF CURB
- || THROUGH CJ SCUPPER

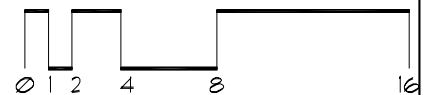

Roof Corrective Action

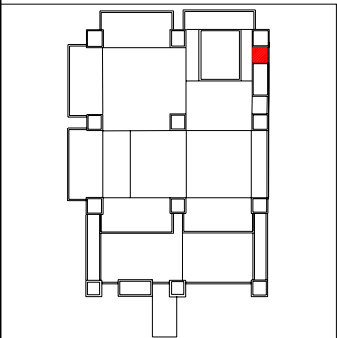
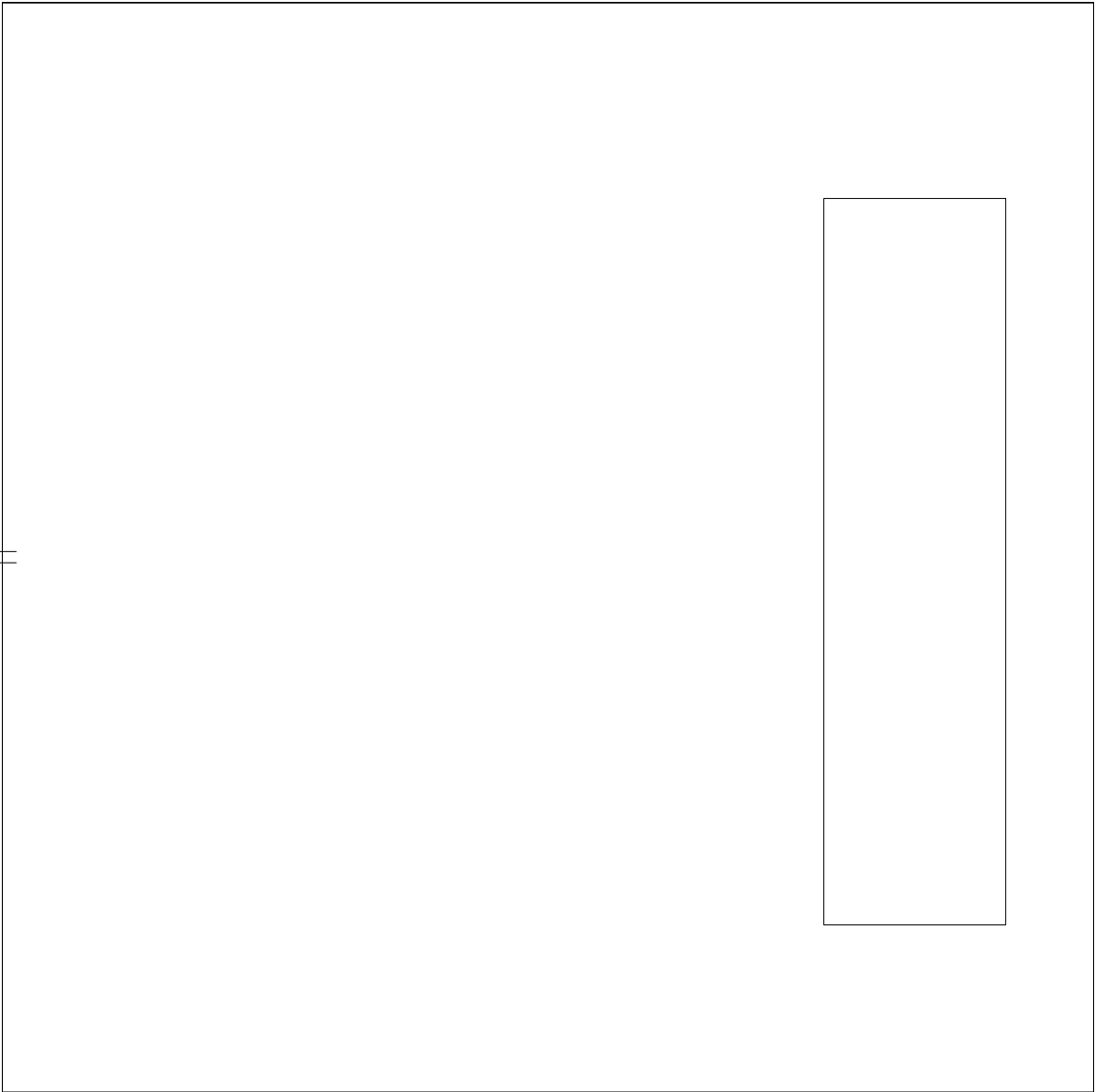

SYMBOLS KEY
□ ROOF CURB
†† SCUPPER

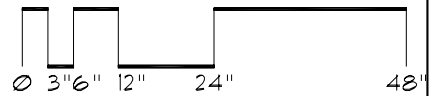

Roof Corrective Action

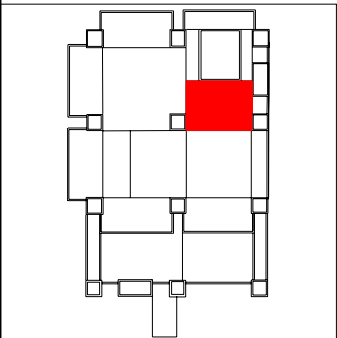
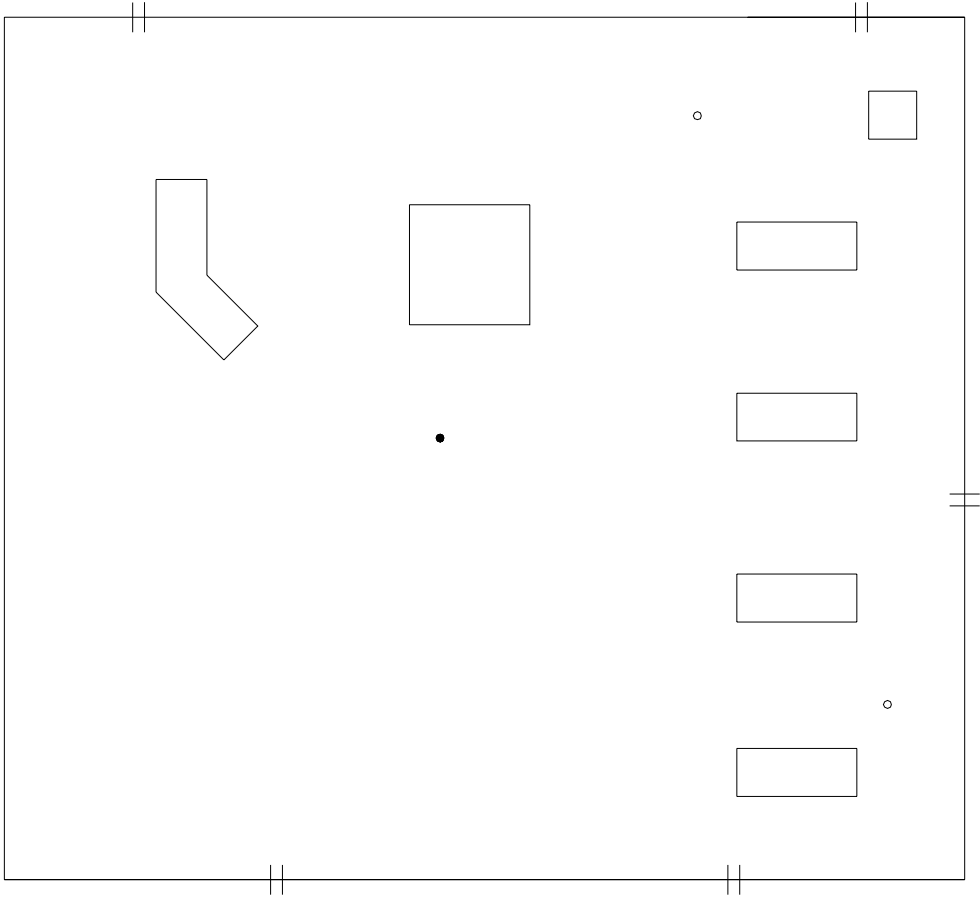

- SYMBOLS KEY**
- VENT STACK
 - ROOF DRAIN
 - ROOF CURB
 - ≡≡ THROUGH CJ SCUPPER

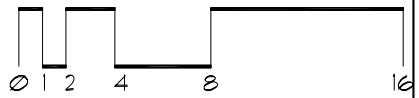

Roof Corrective Action

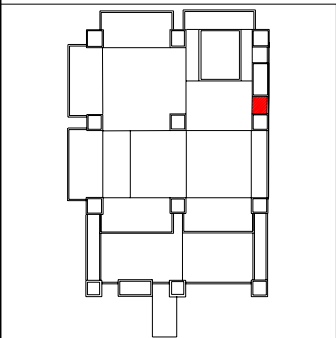
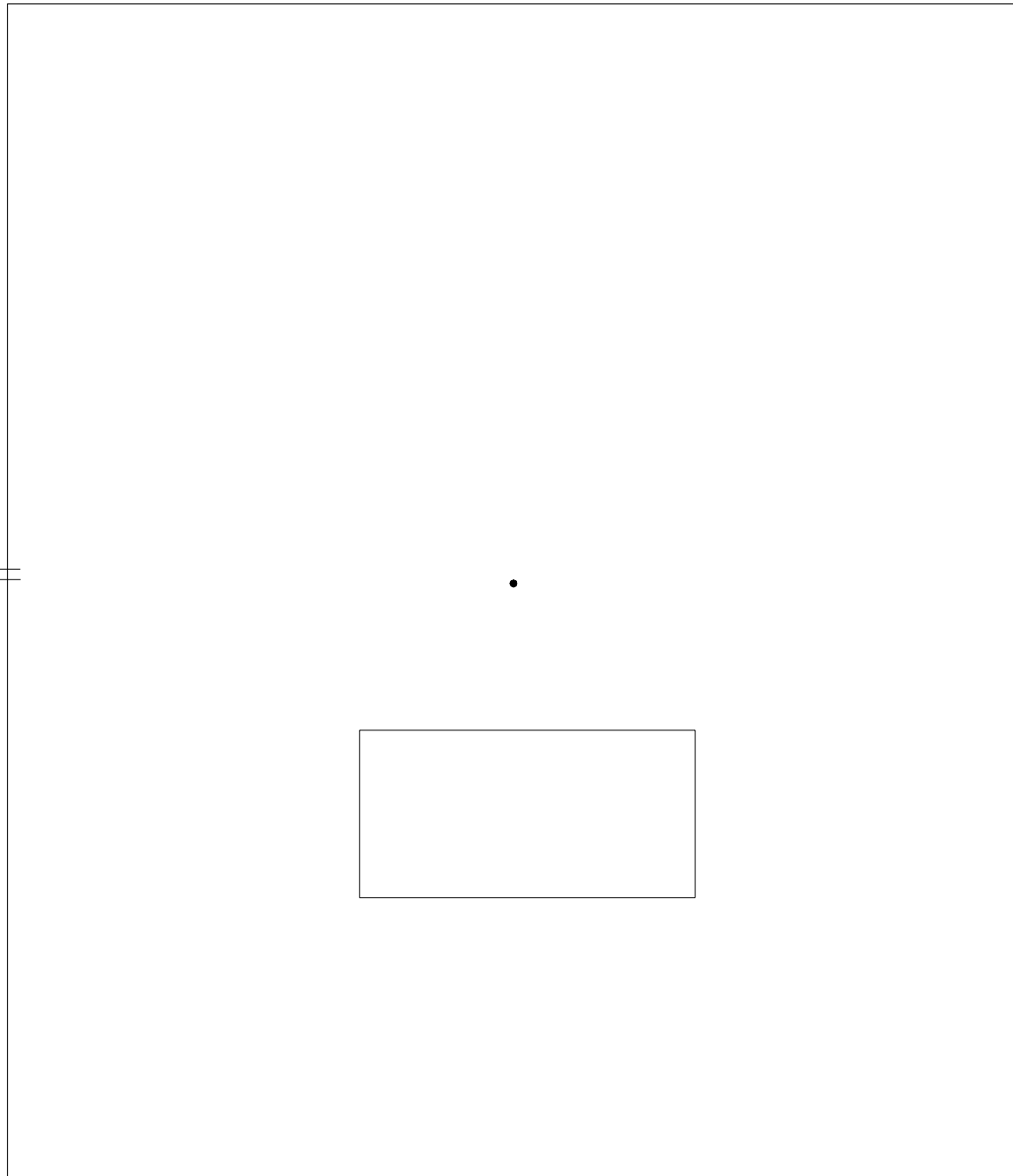

SYMBOLS KEY

- ROOF DRAIN
- ROOF CURB
- †† THROUGH CJ SCUPPER

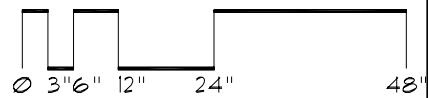

Roof Corrective Action

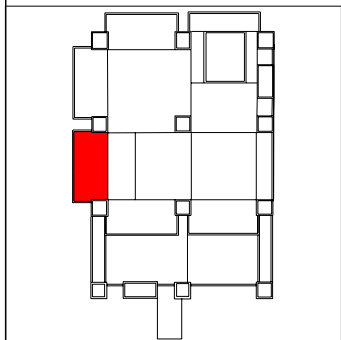
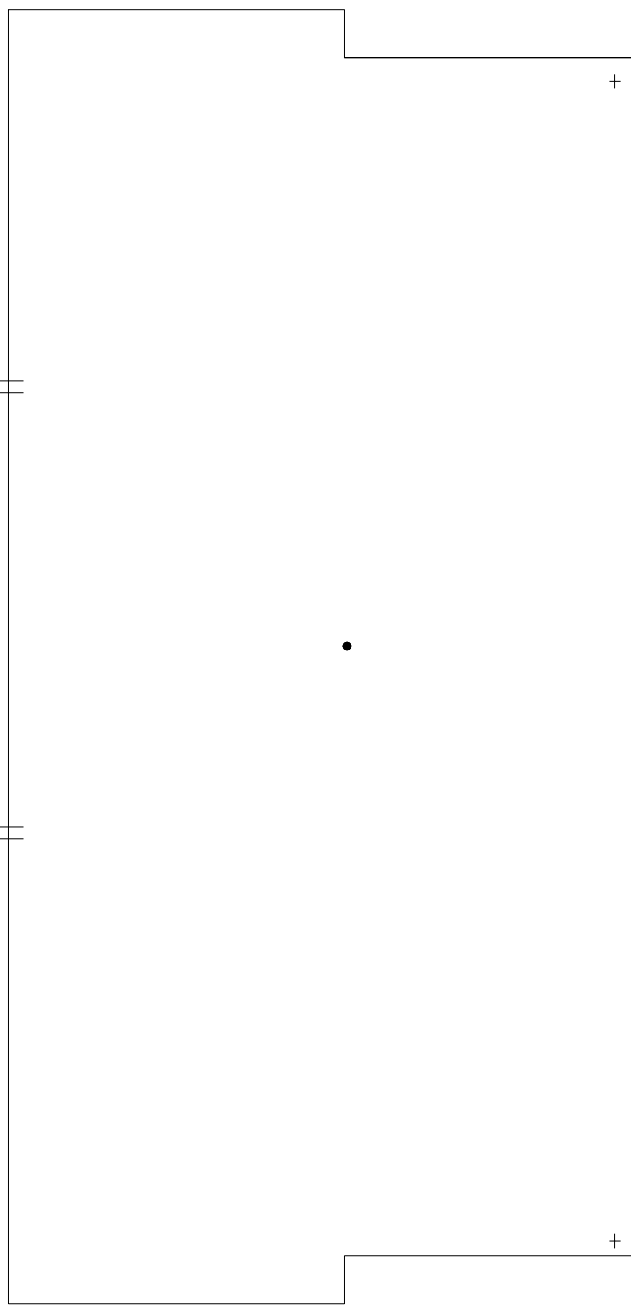

SYMBOLS KEY

- ROOF DRAIN
- † LIGHTING PROTECTION
- †† THROUGH CJ OVERFLOW SCUPPER

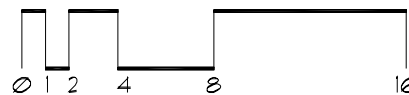

Roof Corrective Action

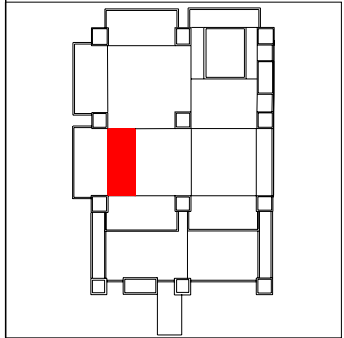
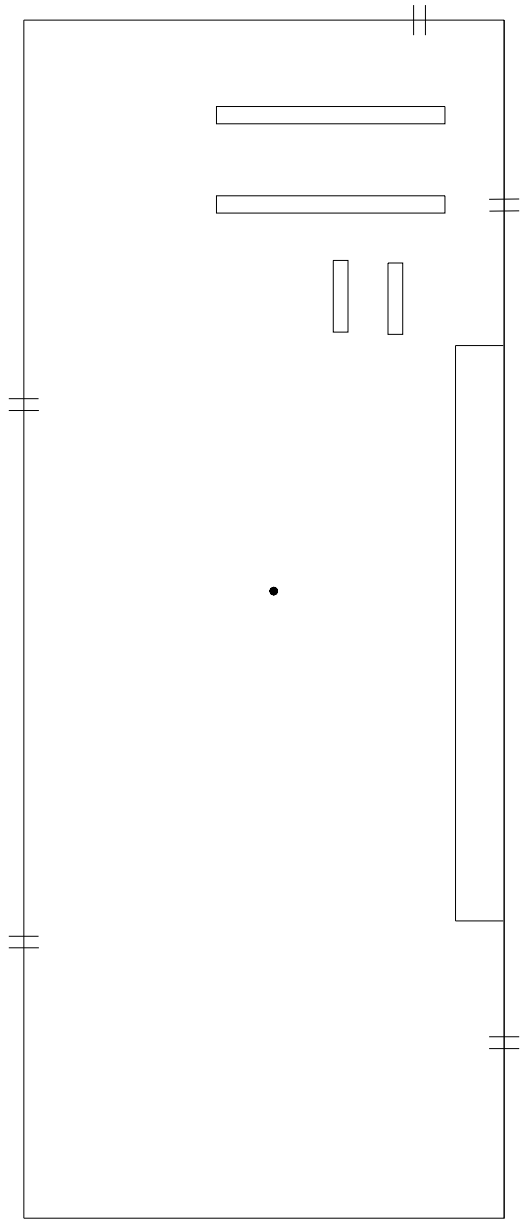

- SYMBOLS KEY**
- ROOF DRAIN
 - ≡ SLEEPER CURB
 - †† THROUGH CJ SCUPPER

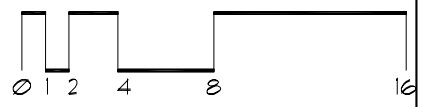

Roof Corrective Action

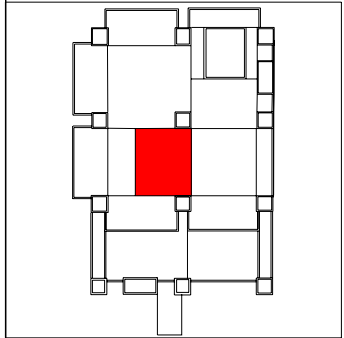
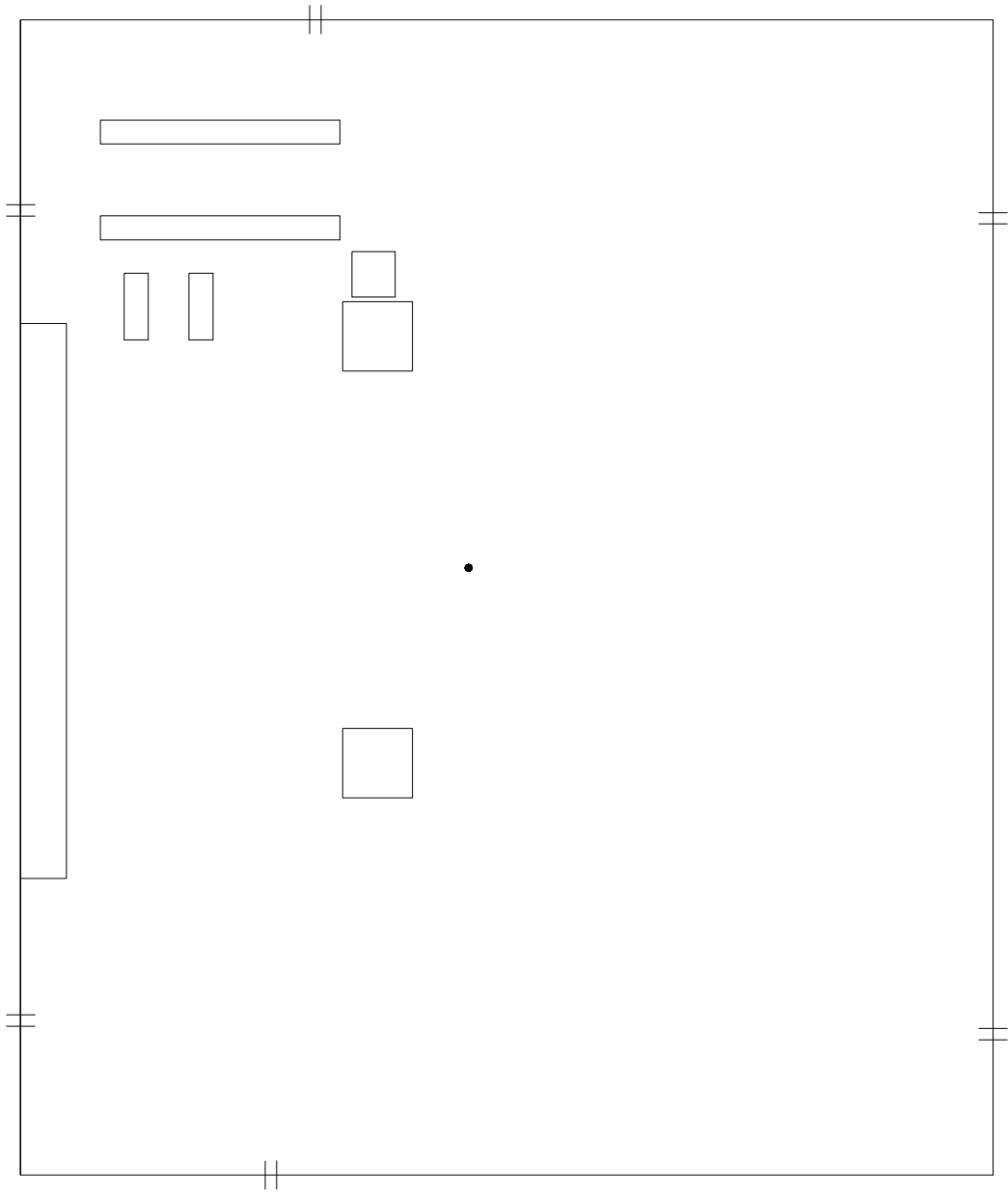

- SYMBOLS KEY**
- ROOF DRAIN
 - ROOF CURB
 - ⊕ THROUGH CJ SCUPPER
 - ≡ SLEEPER CURB

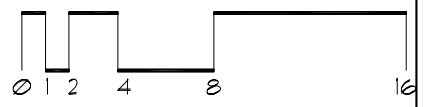
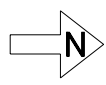

Roof Corrective Action

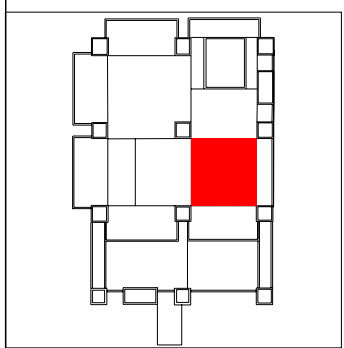
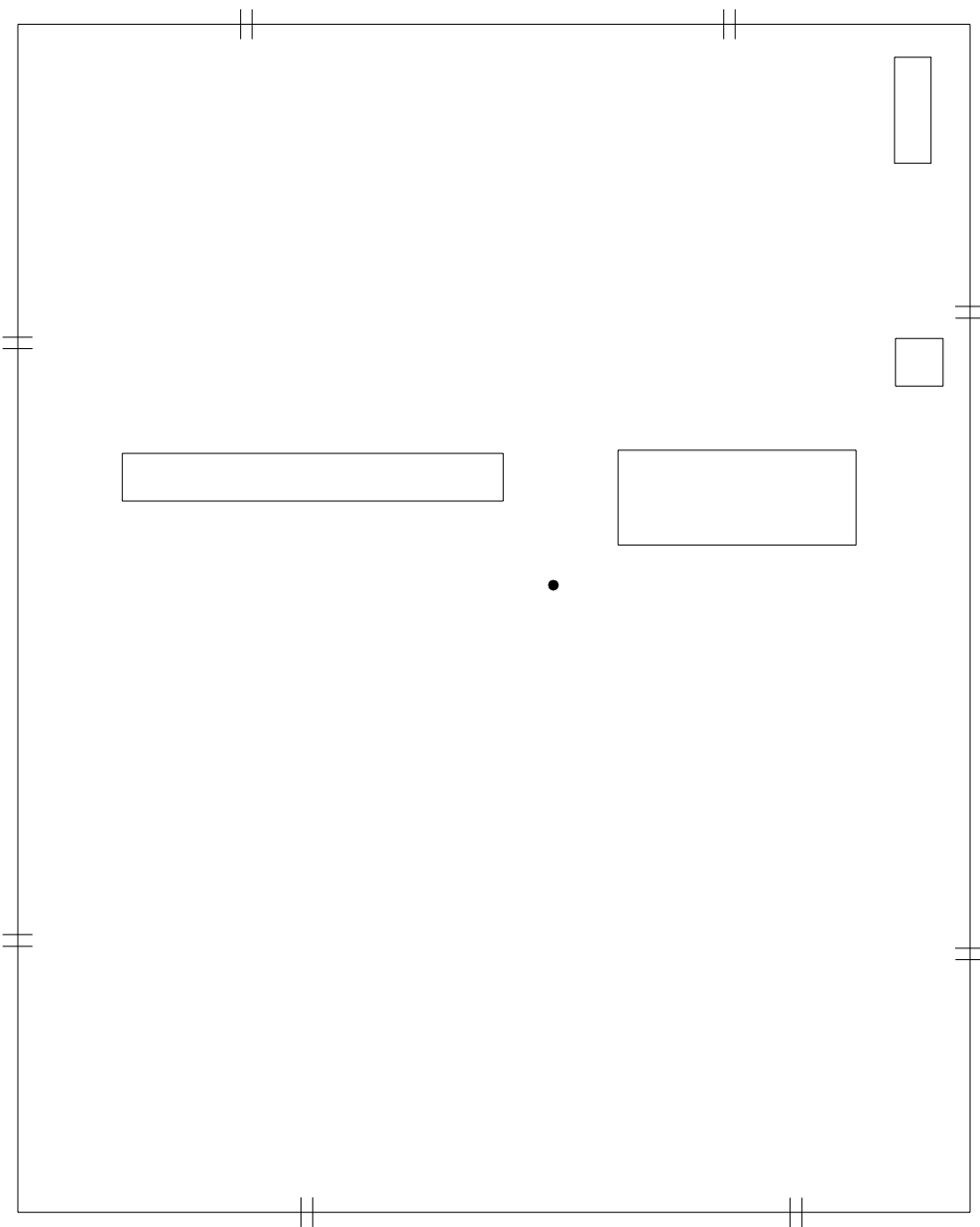

- SYMBOLS KEY**
- ROOF DRAIN
 - ROOF CURB
 - ≡≡ THROUGH ROOF SCUPPER

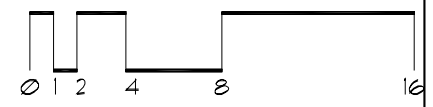
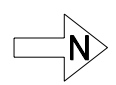

Roof Corrective Action

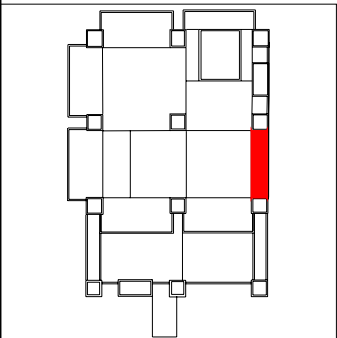
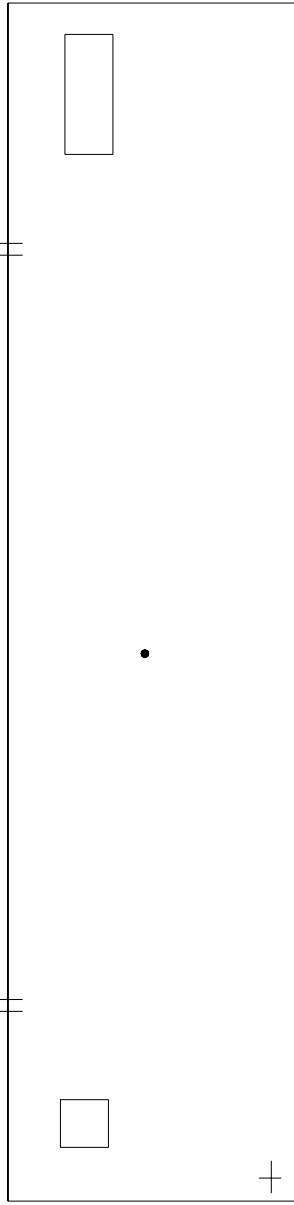

- SYMBOLS KEY
- ROOF DRAIN
 - ROOF CURB
 - ⊕ THROUGH CJ SCUPPER
 - ⊕ LIGHTNING PROTECTION

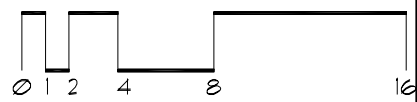
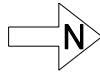

Roof Corrective Action

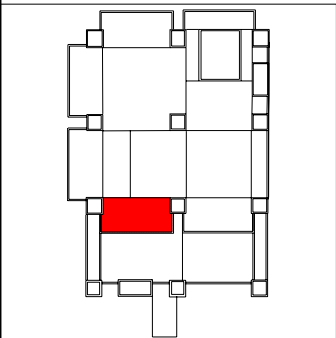
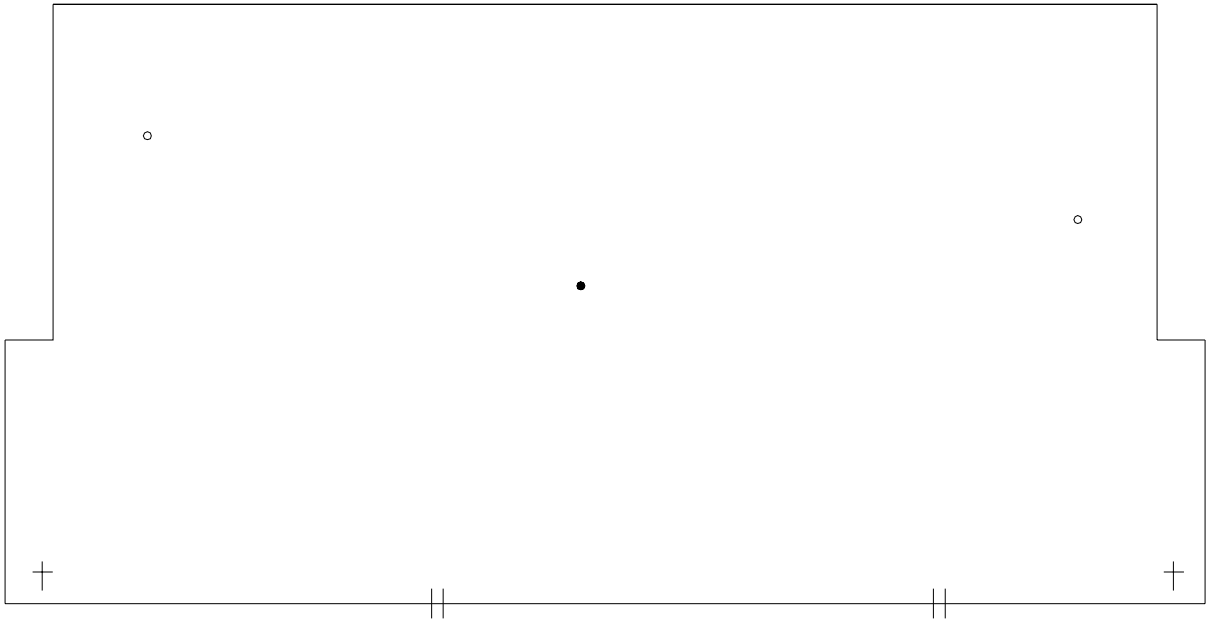

SYMBOLS KEY

- VENT STACK
- ROOF DRAIN
- † LIGHTNING PROTECTION
- ‡ THROUGH CJ SCUPPER

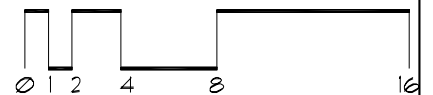

Roof Corrective Action

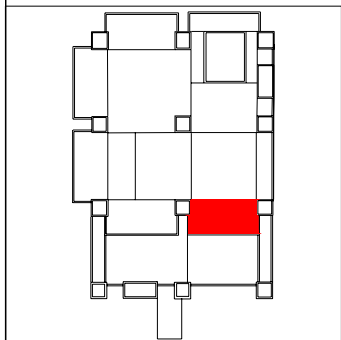
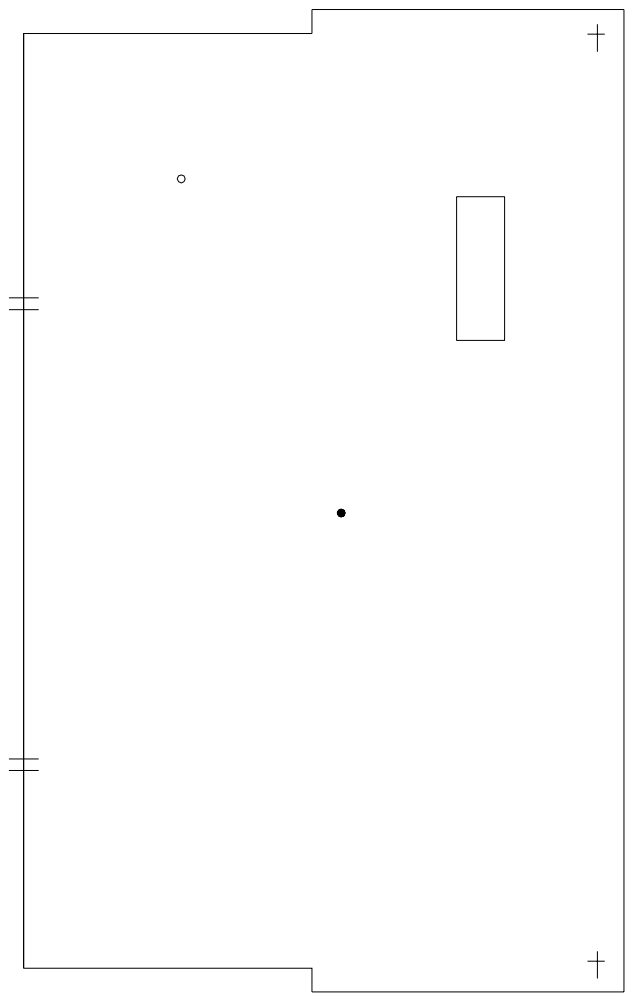

- SYMBOLS KEY**
- VENT STACK
 - ROOF DRAIN
 - ROOF CURB
 - ⊕ THROUGH CJ SCUPPER
 - ⊕ LIGHTNING PROTECTION

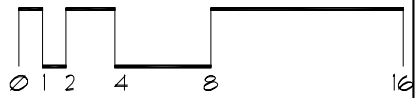
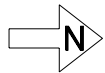

Roof Corrective Action

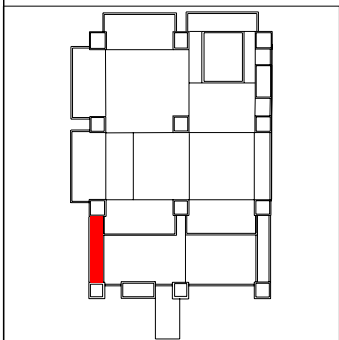
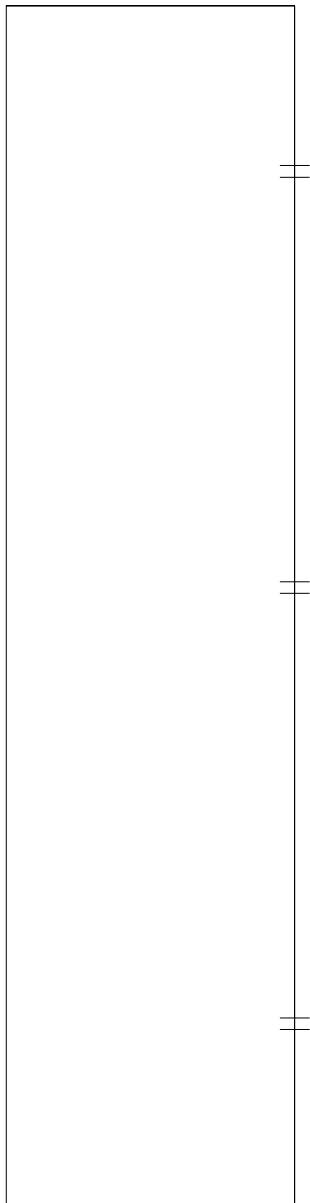

SYMBOLS KEY
|| SCUPPER

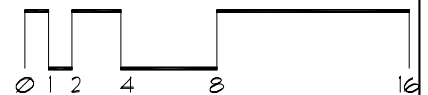

Roof Corrective Action

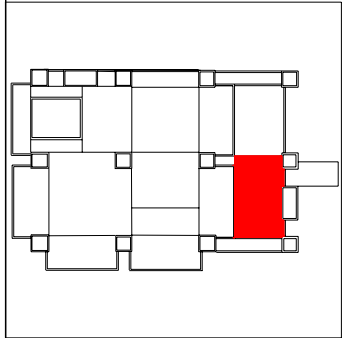
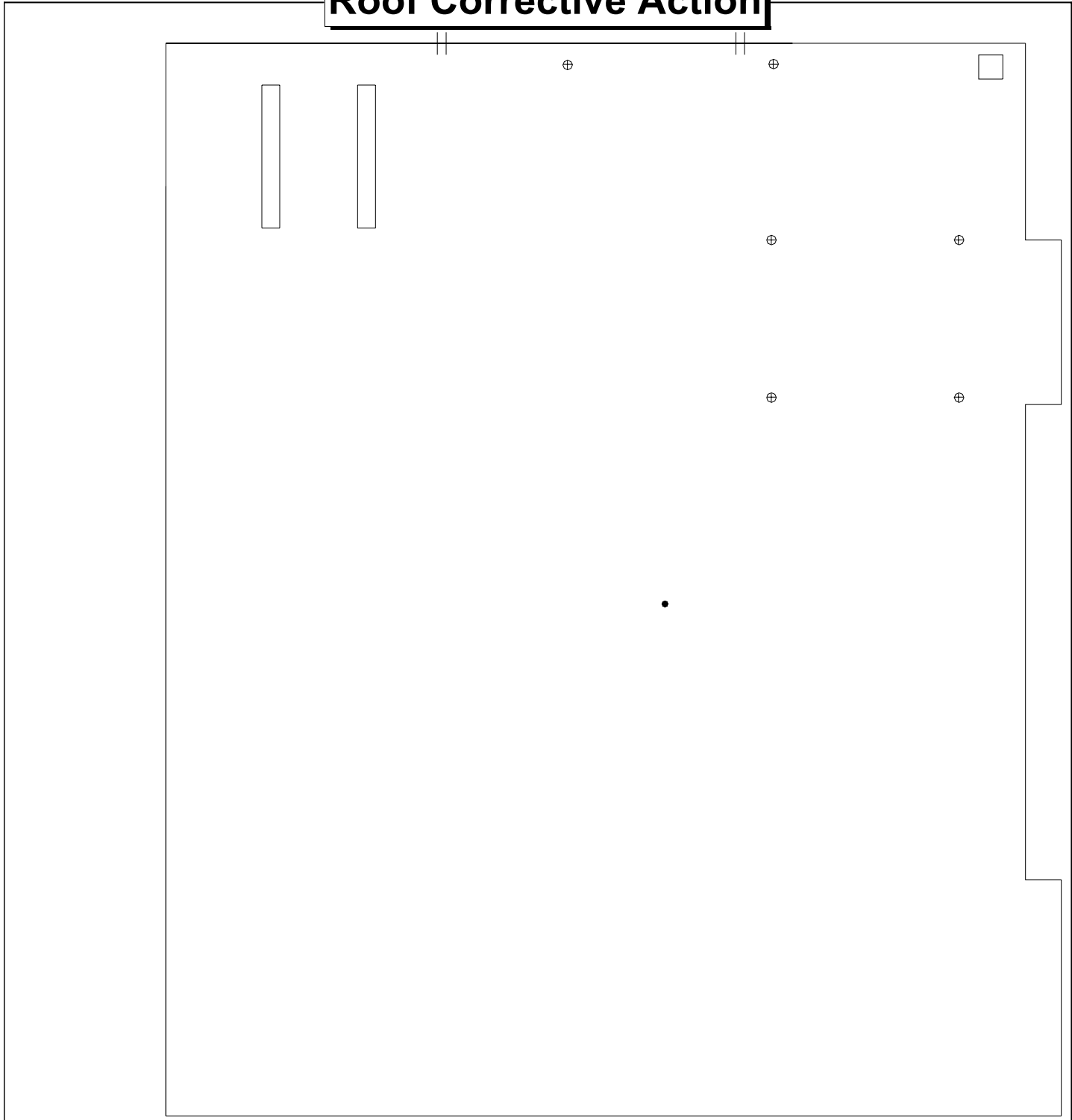

- SYMBOLS KEY**
- ROOF DRAIN
 - ≡ SLEEPER CURB
 - ⊥ THROUGH CJ SCUPPER
 - † PIPE PENETRATION
 - ROOF CURB
 - Ⓢ DEFECT-REPAIR

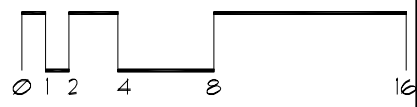

Roof Corrective Action

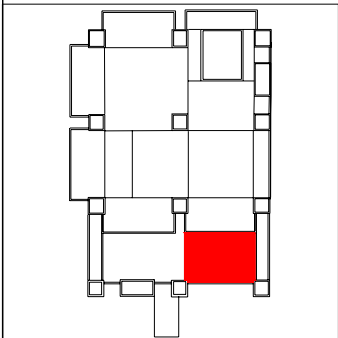
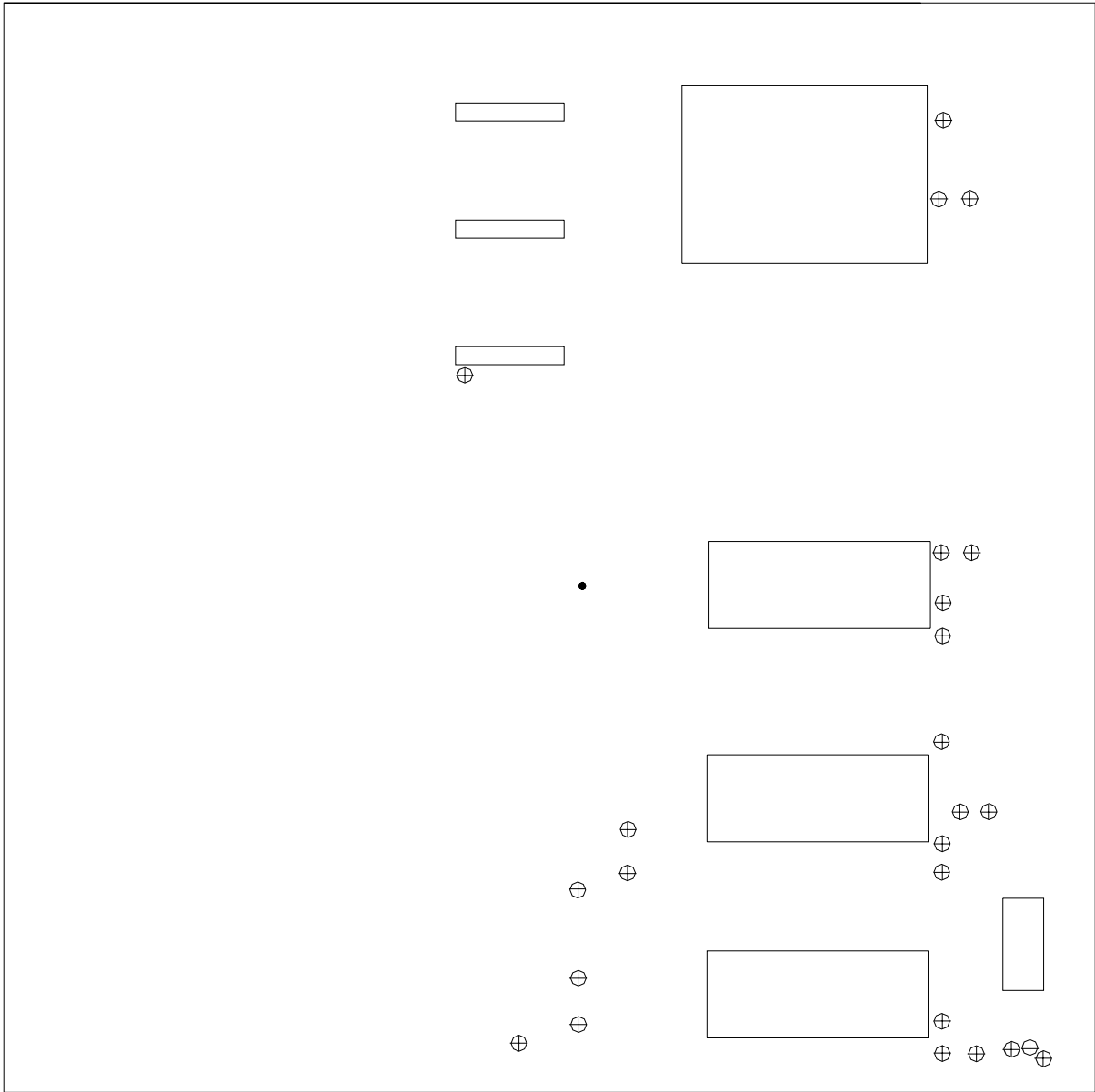

SYMBOLS KEY

- ROOF DRAIN
- ROOF CURB
- † PIPE PENETRATION
- Ⓢ DEFECT-REPAIR
- Ⓣ DEFECT-NO REPAIR
- ≡ SLEEPER CURB

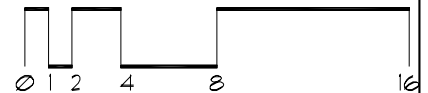

Roof Corrective Action

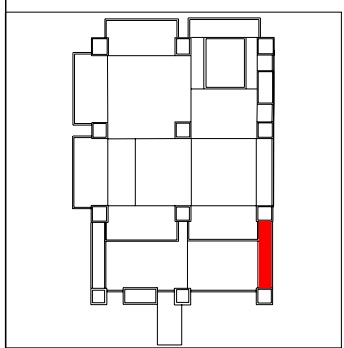
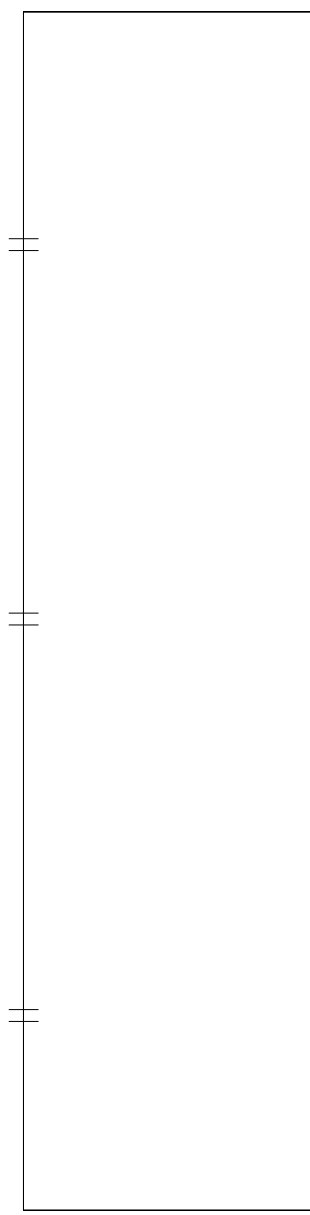

SYMBOLS KEY
⊥ SCUPPER
⊙ DEFECT-NO REPAIR

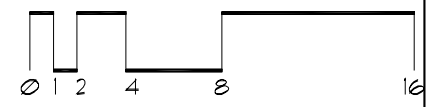
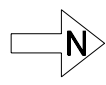

Roof Corrective Action

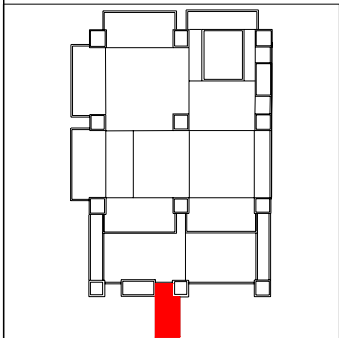
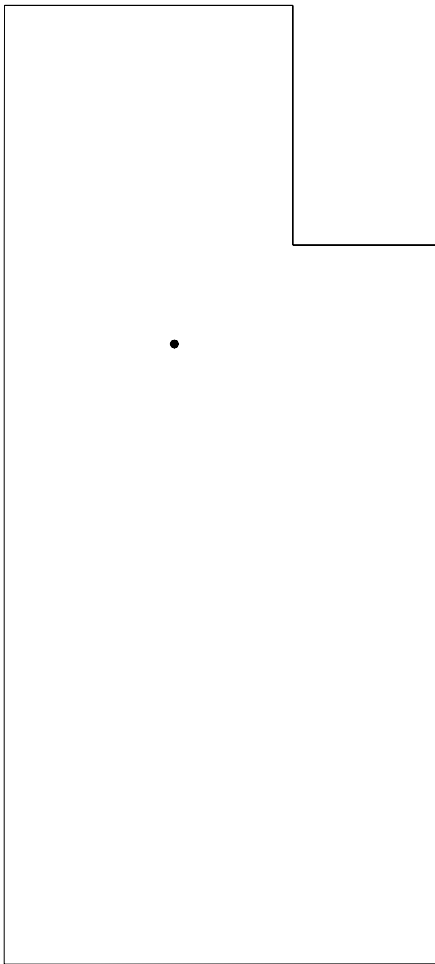

SYMBOLS KEY
• ROOF DRAIN

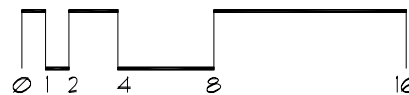

Roof ID

144 - PWB

Building: HS145 - ~~Phillips Wang Link~~ - (516 Delaware Street SE Minneapolis)

Roof Access: 10th floor north stairs

Total Area: 4,670 sf

A 2,232 sf

B 2,294 sf

C 144 sf

Revised
Name = Z

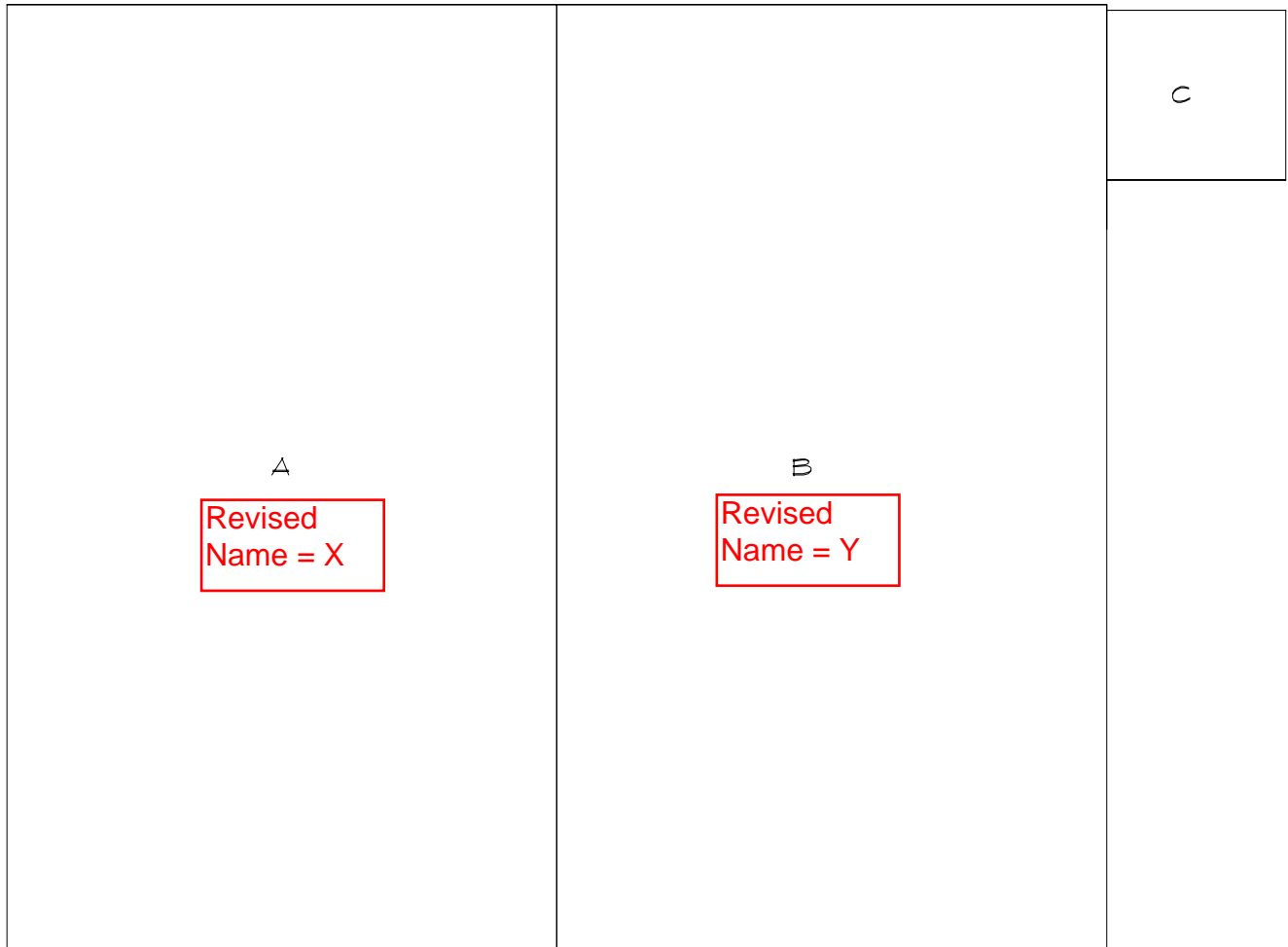

Roof Corrective Action

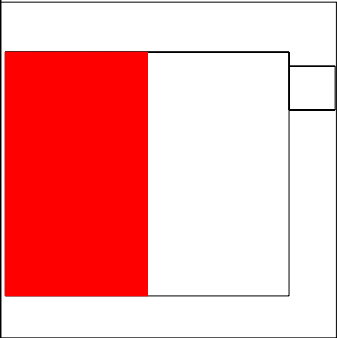
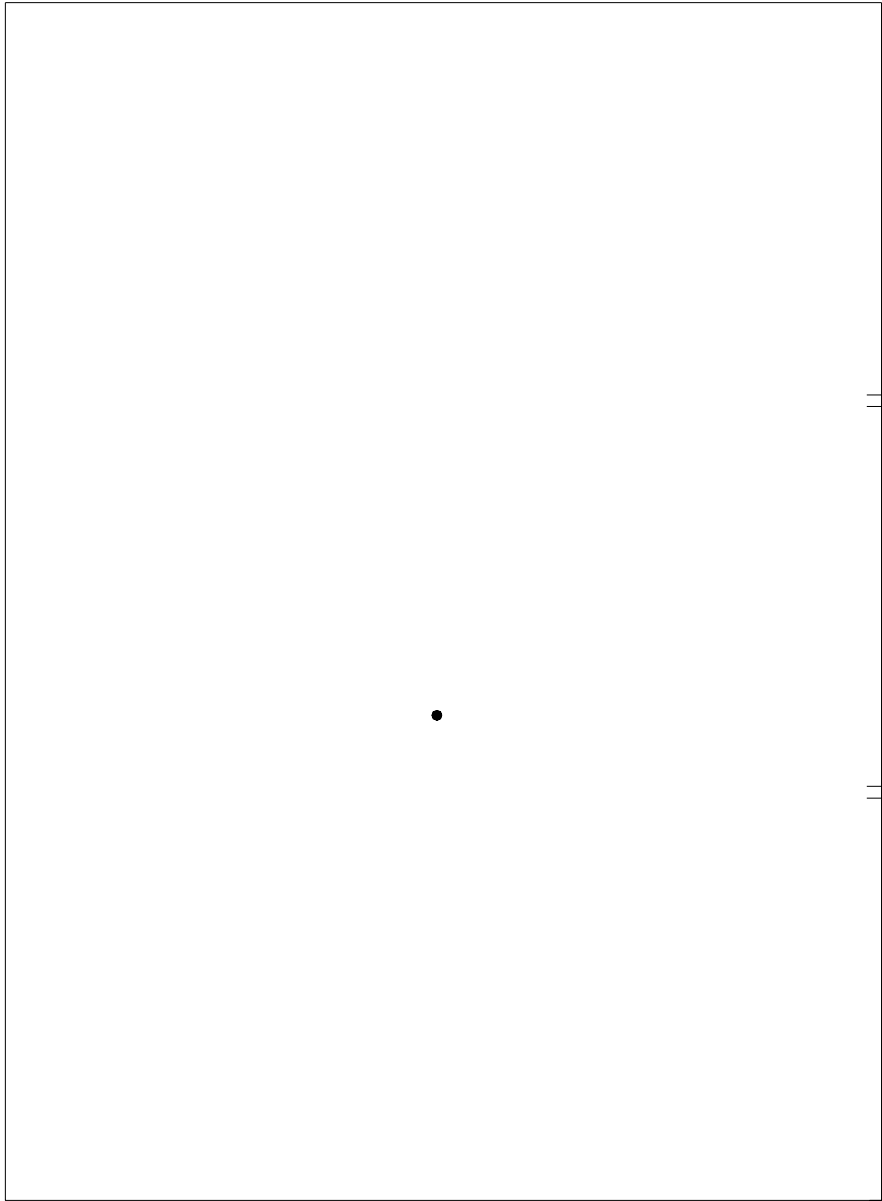

SYMBOLS KEY
● ROOF DRAIN
†† THROUGH CJ SCUPPER
DEFECT-REPAIR

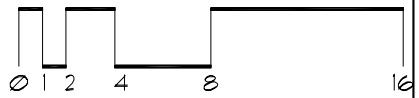
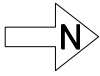

Roof Corrective Action

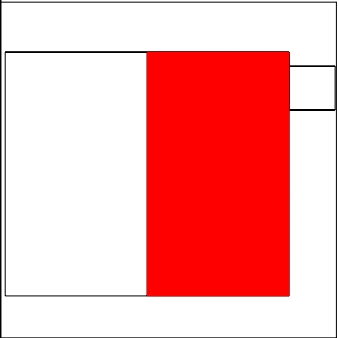
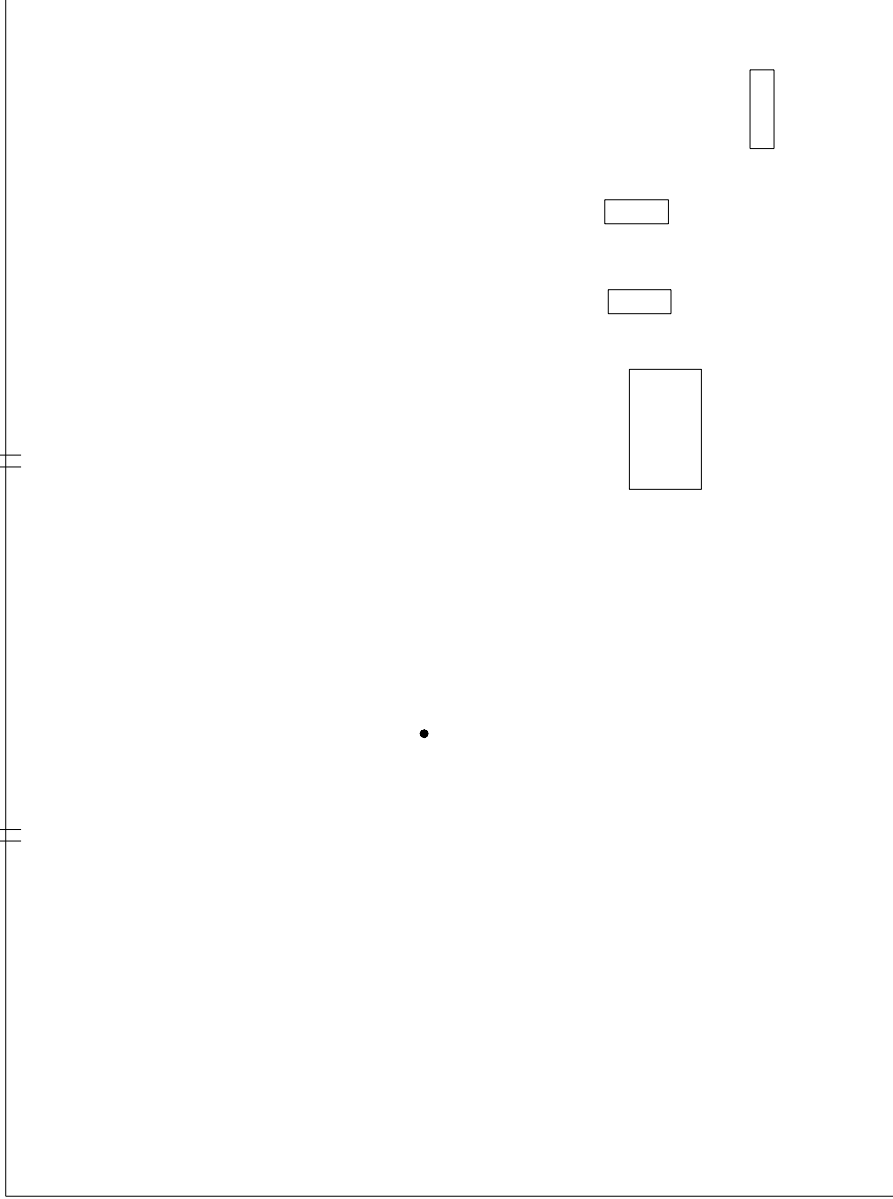

- SYMBOLS KEY**
- ROOF DRAIN
 - ROOF CURB
 - ⦶ THROUGH CJ SCUPPER

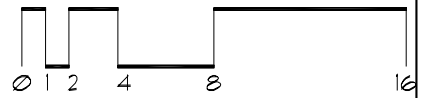
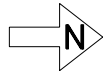

Roof Corrective Action

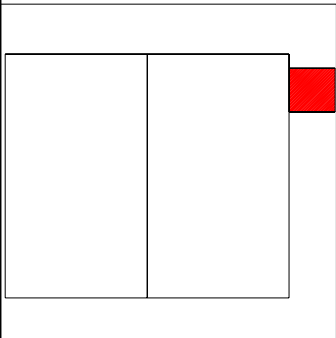
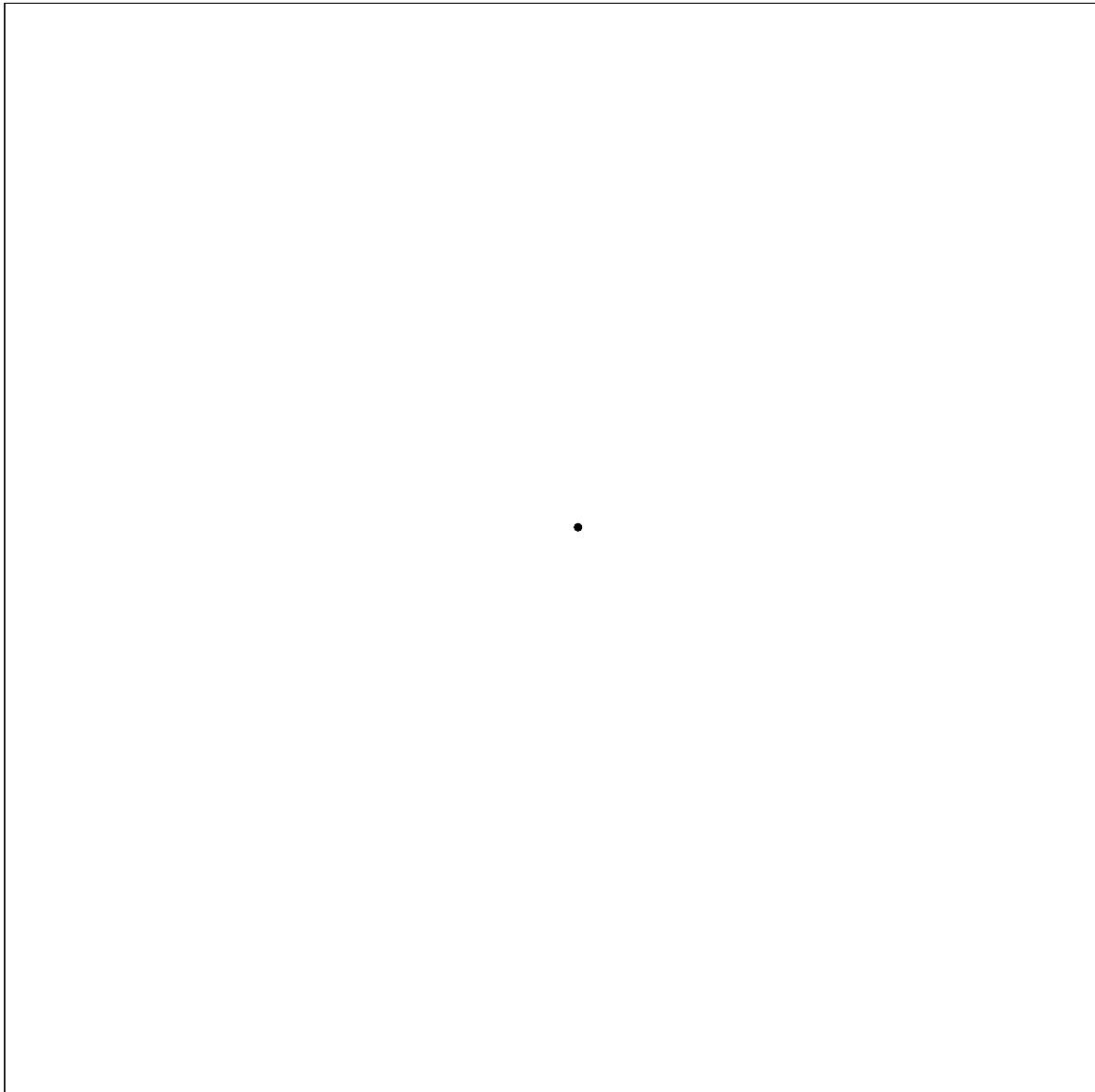

SYMBOLS KEY
● ROOF DRAIN

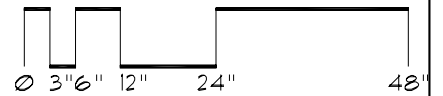

Roof ID

144 - PWB

Building: ~~HS146 - Phillips Wang~~ Exec. Link - (516 Delaware Street SE Minneapolis)

Roof Access: 15th floor north stairs

Total Area: 3,192 sf

A 1,596 sf

B 1,596 sf

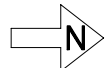
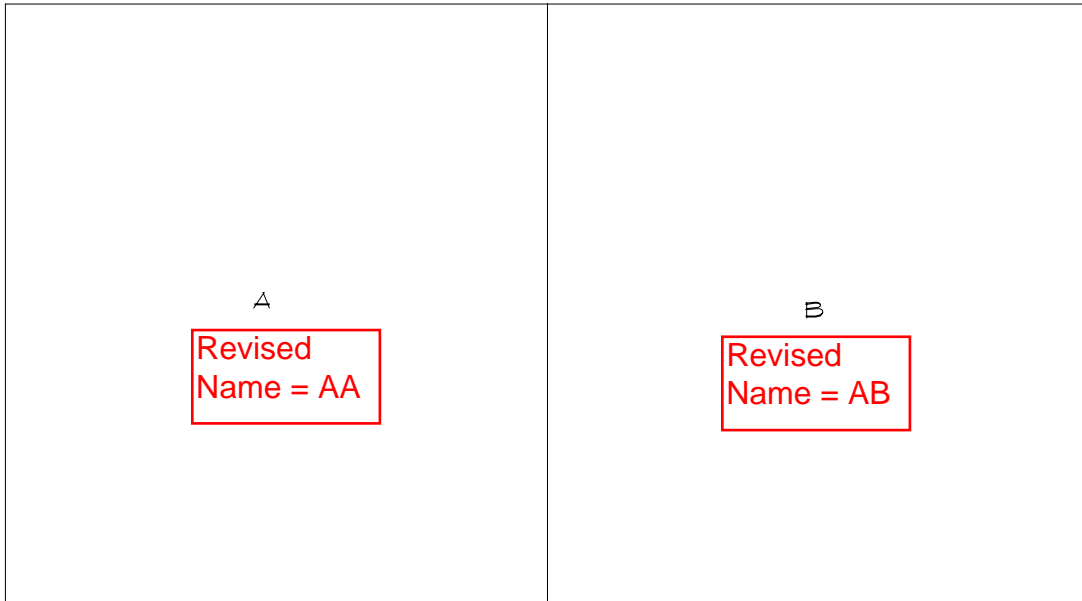

Roof Corrective Action

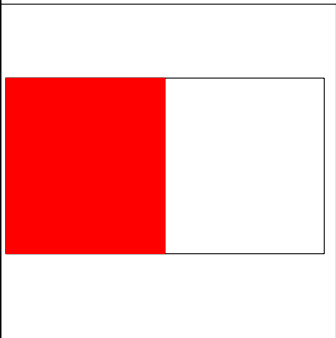
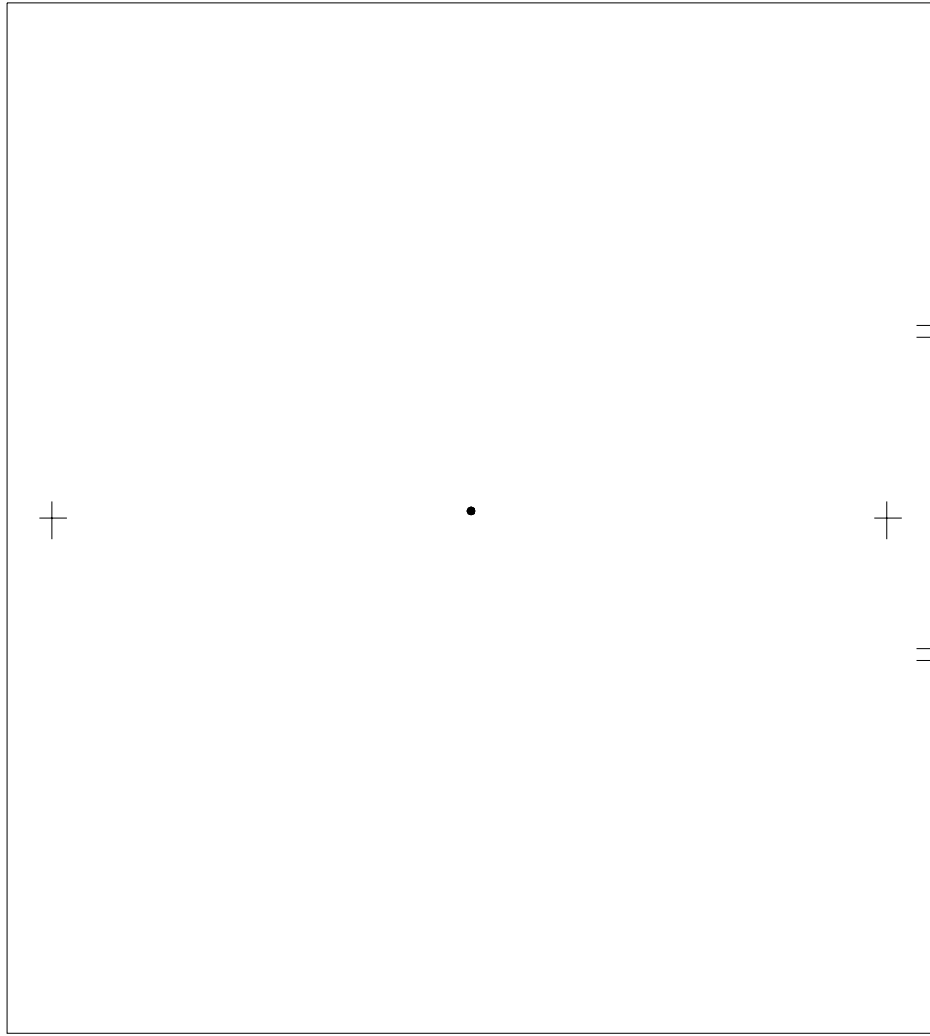

SYMBOLS KEY
● ROOF DRAIN
+ LIGHTNING PROTECTION
|| THROUGH CJ SCUPPER

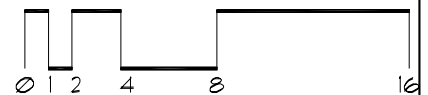

Roof Corrective Action

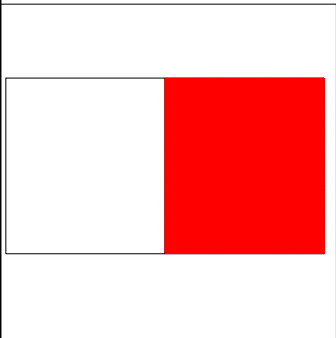
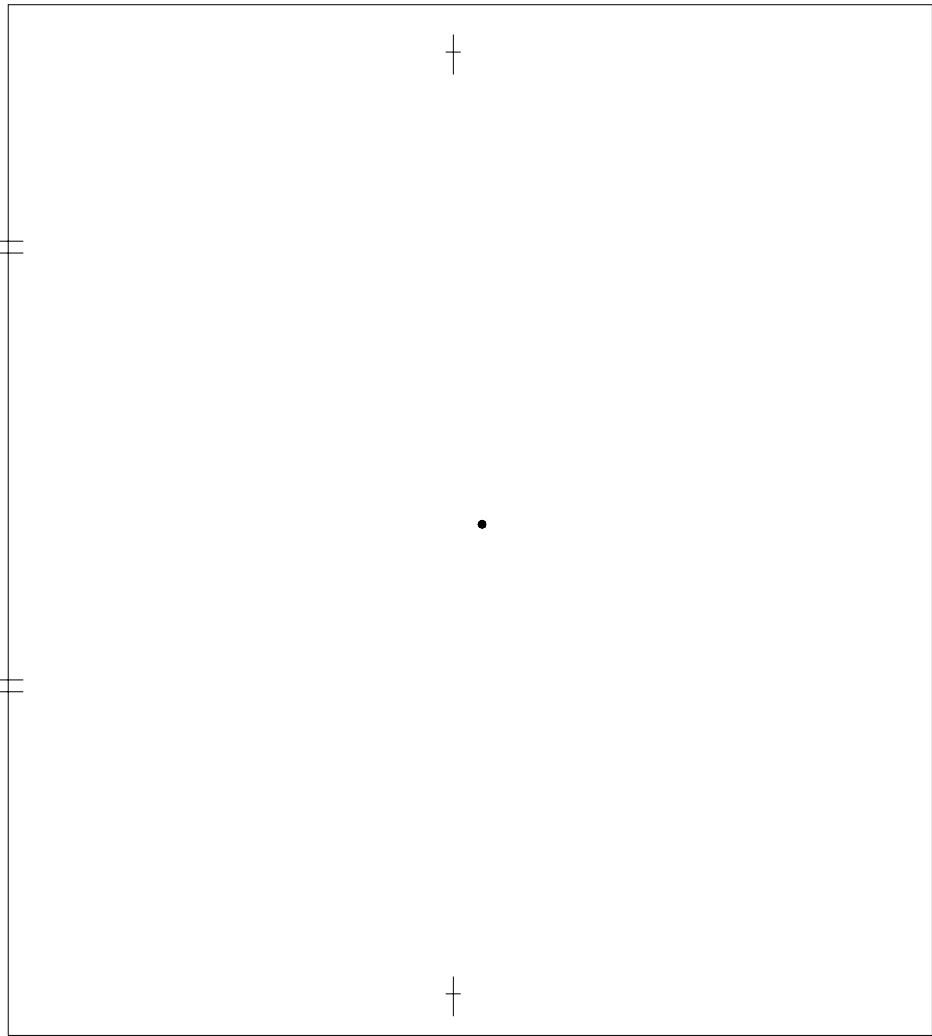

SYMBOLS KEY
● ROOF DRAIN
≡ THROUGH CJ SCUPPER
+ LIGHTNING PROTECTION

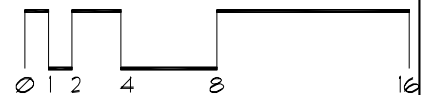
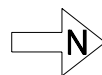

Roof ID

Building: HS147 - Weaver-Densford Hall - (308 Harvard St SE)

Total Area: 22,408 sf

A	742 sf	E	800 sf	I	128 sf	M	1,250 sf	Q	4,934 sf	U	144 sf
B	965 sf	F	751 sf	J	250 sf	N	144 sf	R	144 sf	V	536 sf
C	725 sf	G	170 sf	K	128 sf	O	144 sf	S	144 sf	W	100 sf
D	8,502 sf	H	156 sf	L	156 sf	P	777 sf	T	518 sf	X	100 sf

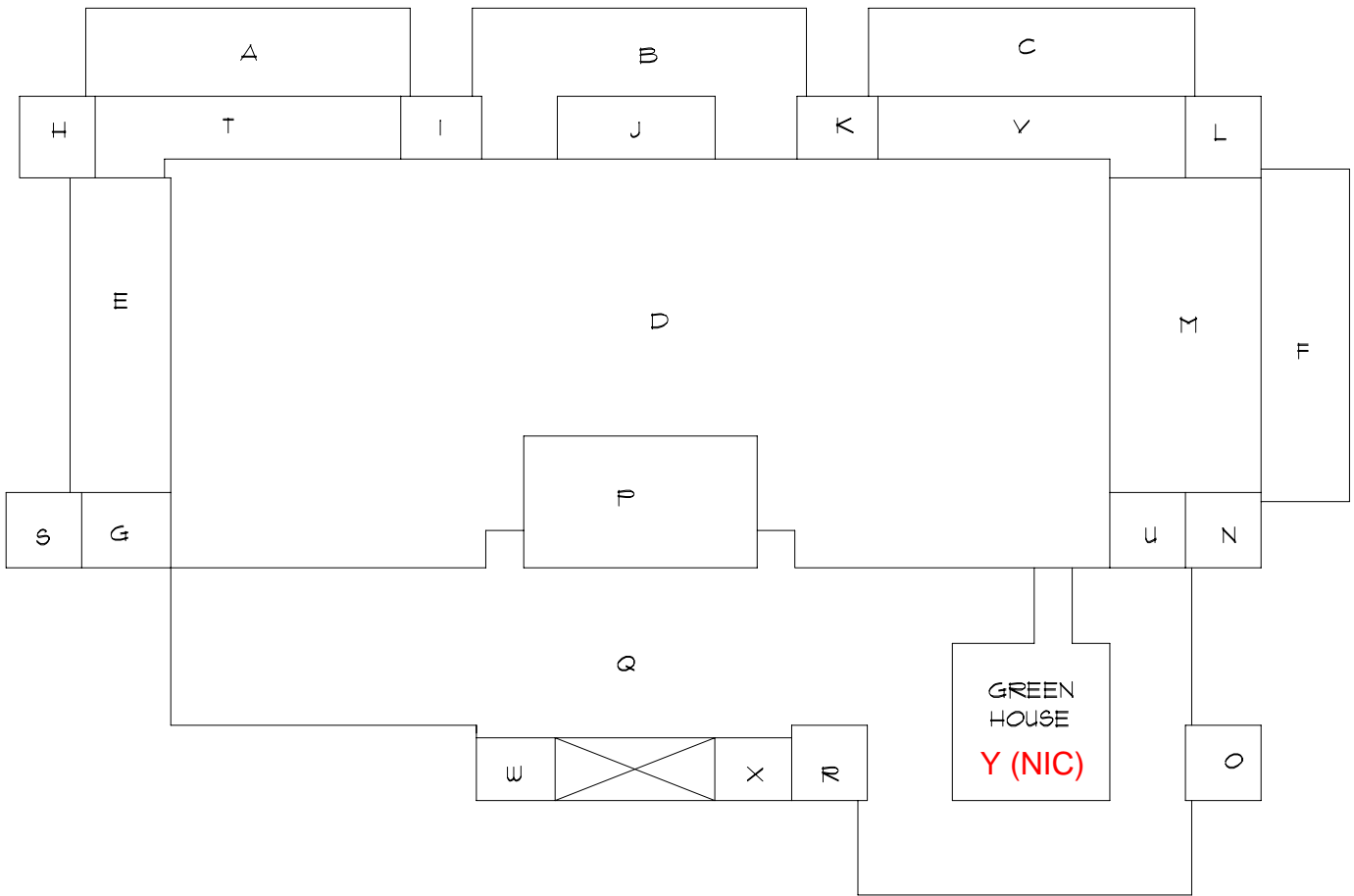

Roof Corrective Action

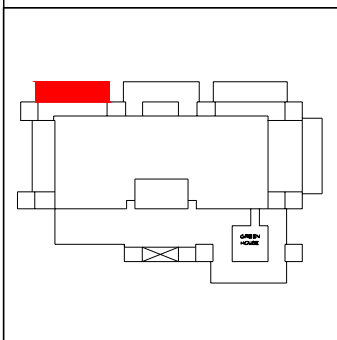
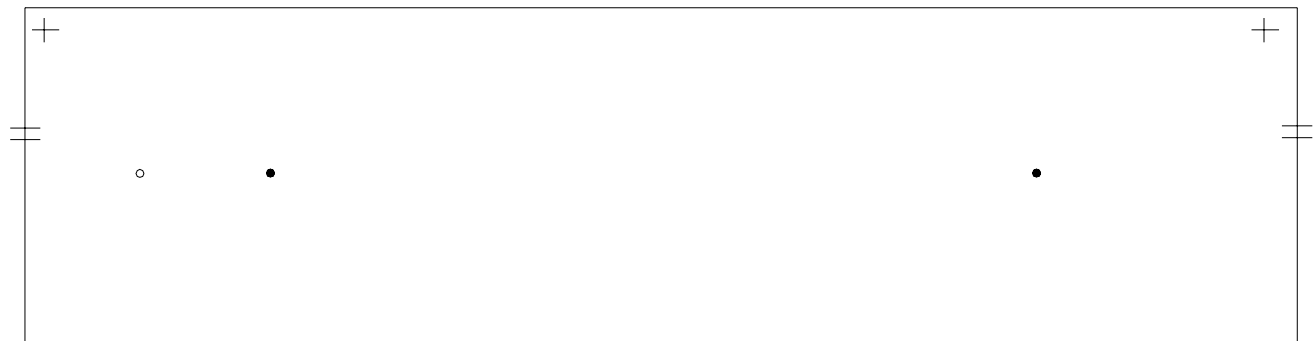

SYMBOLS KEY

- || SCUPPER
 - VENT STACK
 - ROOF DRAIN
 - +
- LIGHTNING PROTECTION

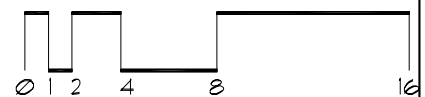
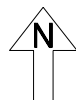

Roof Corrective Action

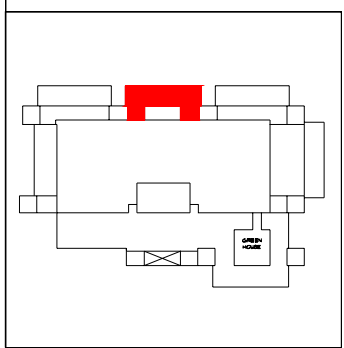
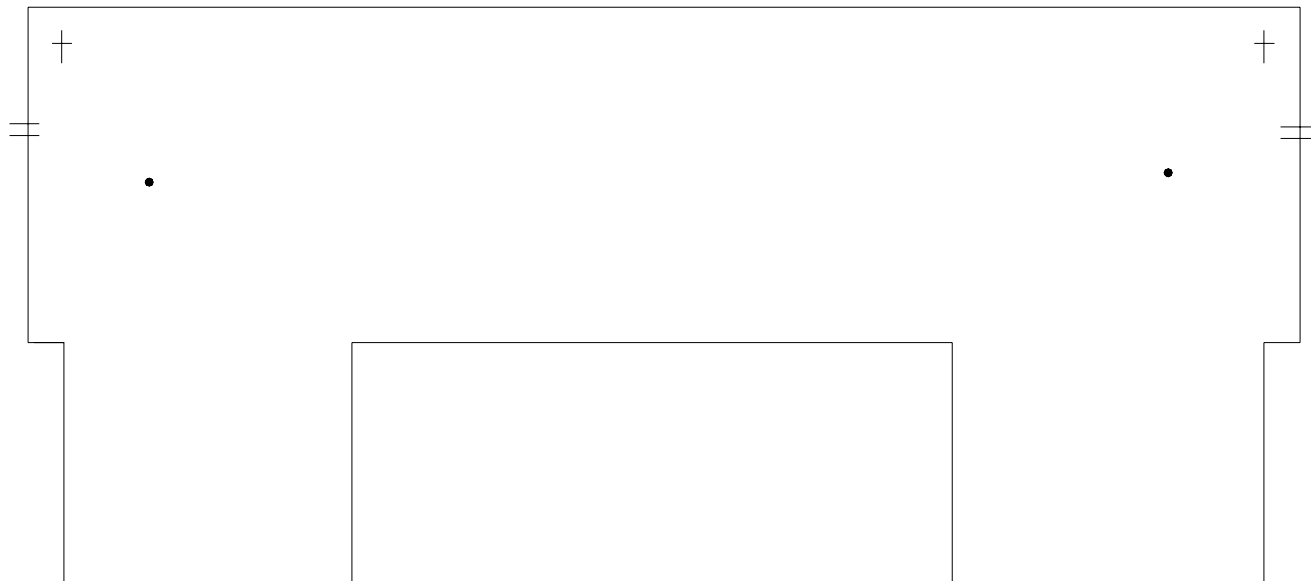

- SYMBOLS KEY**
- ⊥ OVERFLOW SCUPPER
 - ROOF DRAIN
 - ⊕ LIGHTNING PROTECTION

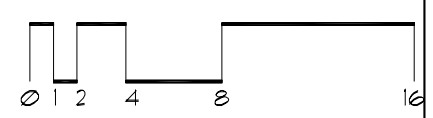

Roof Corrective Action

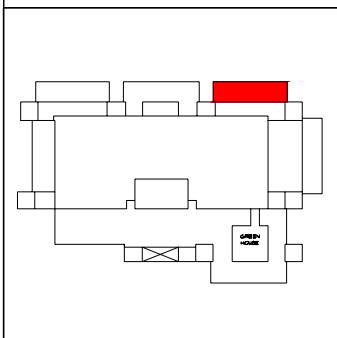
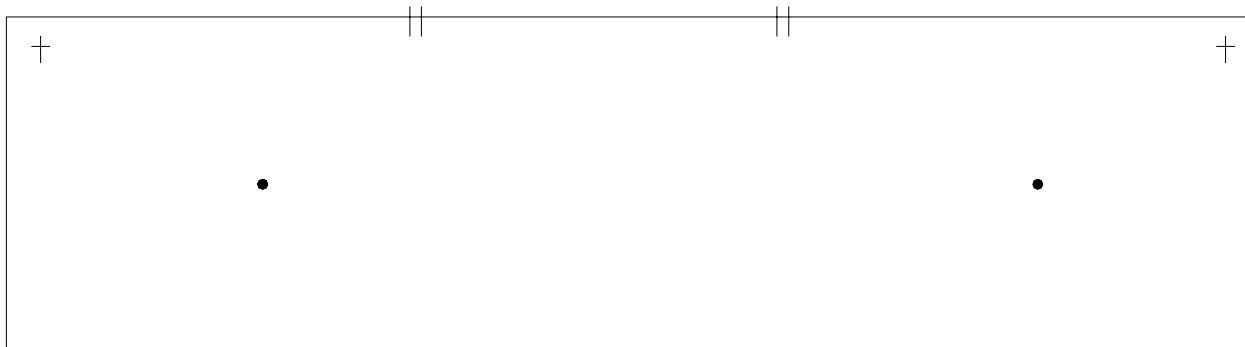

SYMBOLS KEY

- || SCUPPER
- ROOF DRAIN
- † LIGHTNING PROTECTION
- †† OVERFLOW SCUPPER

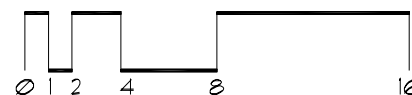

Roof Corrective Action

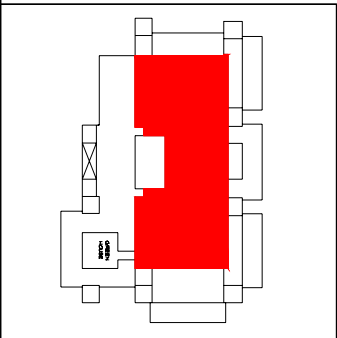
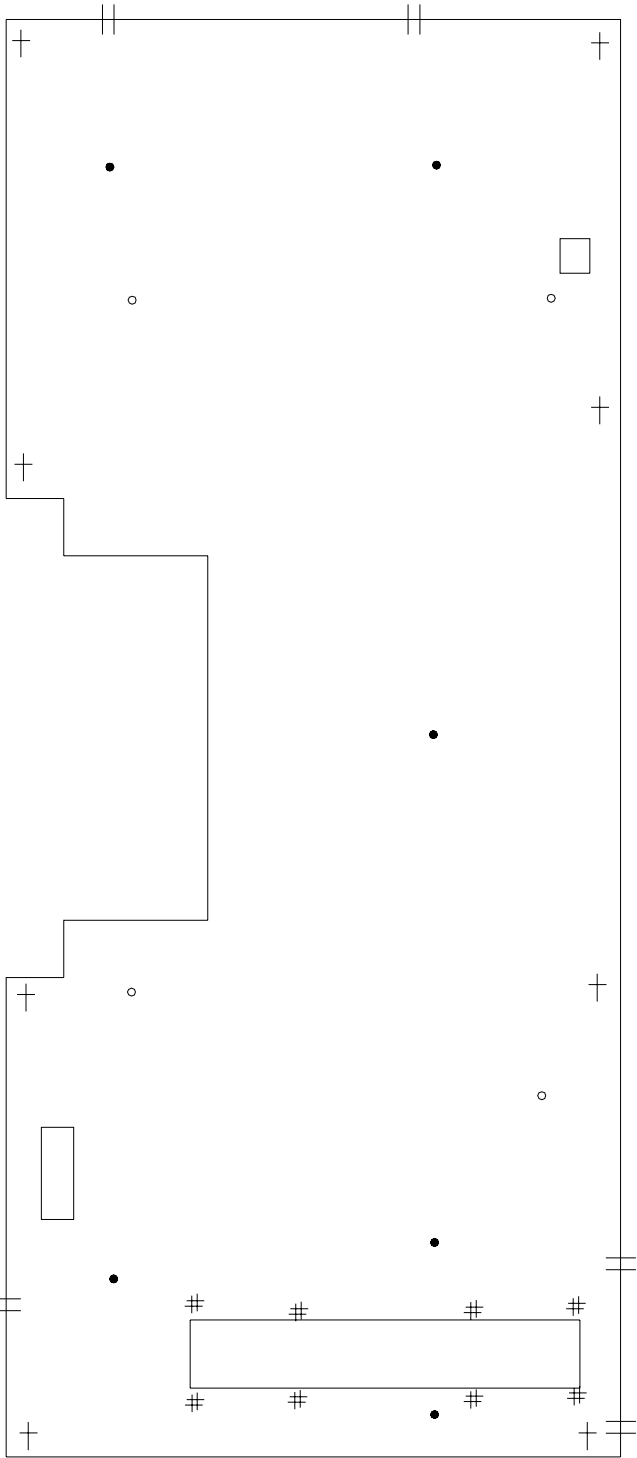

- SYMBOLS KEY**
- VENT STACK
 - ROOF DRAIN
 - ROOF CURB
 - # PITCH PAN
 - || OVERFLOW SCUPPER
 - † LIGHTNING PROTECTION

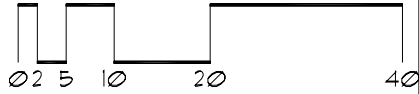

Roof Corrective Action

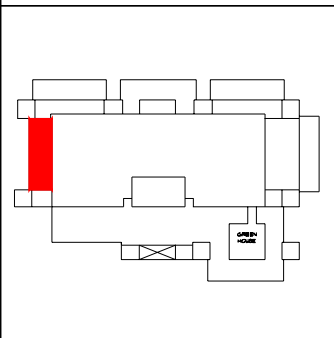
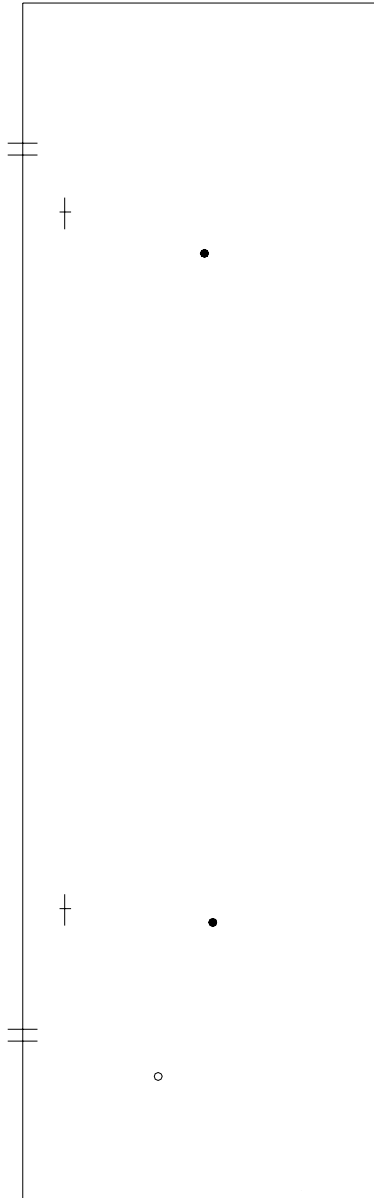

- SYMBOLS KEY**
- ⏏ OVERFLOW SCUPPER
 - VENT STACK
 - ROOF DRAIN
 - † LIGHTING PROTECTION
 - ① DEFECT-NO REPAIR

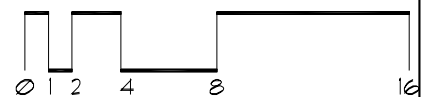

Roof Corrective Action

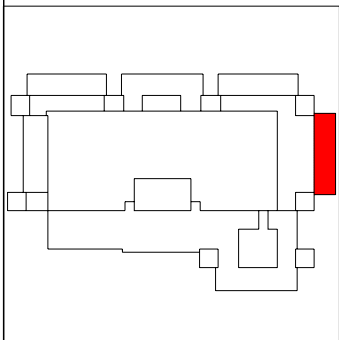
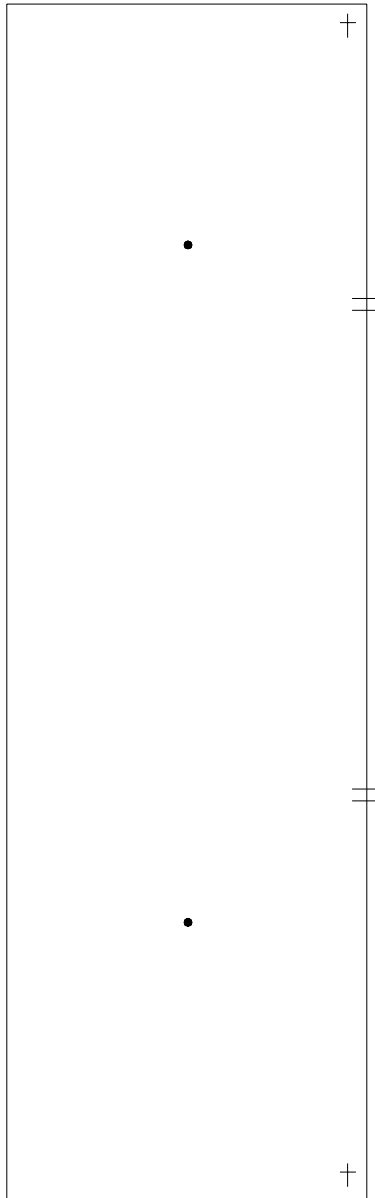

SYMBOLS KEY

- ROOF DRAIN
- ≡ OVERFLOW SCUPPER
- ⊕ LIGHTNING PROTECTION

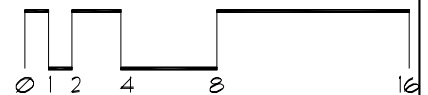

Roof Corrective Action

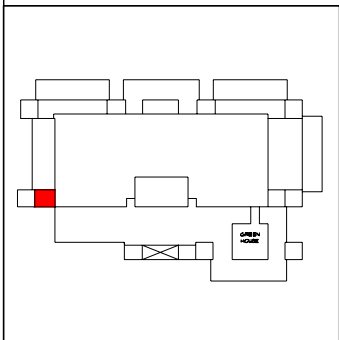
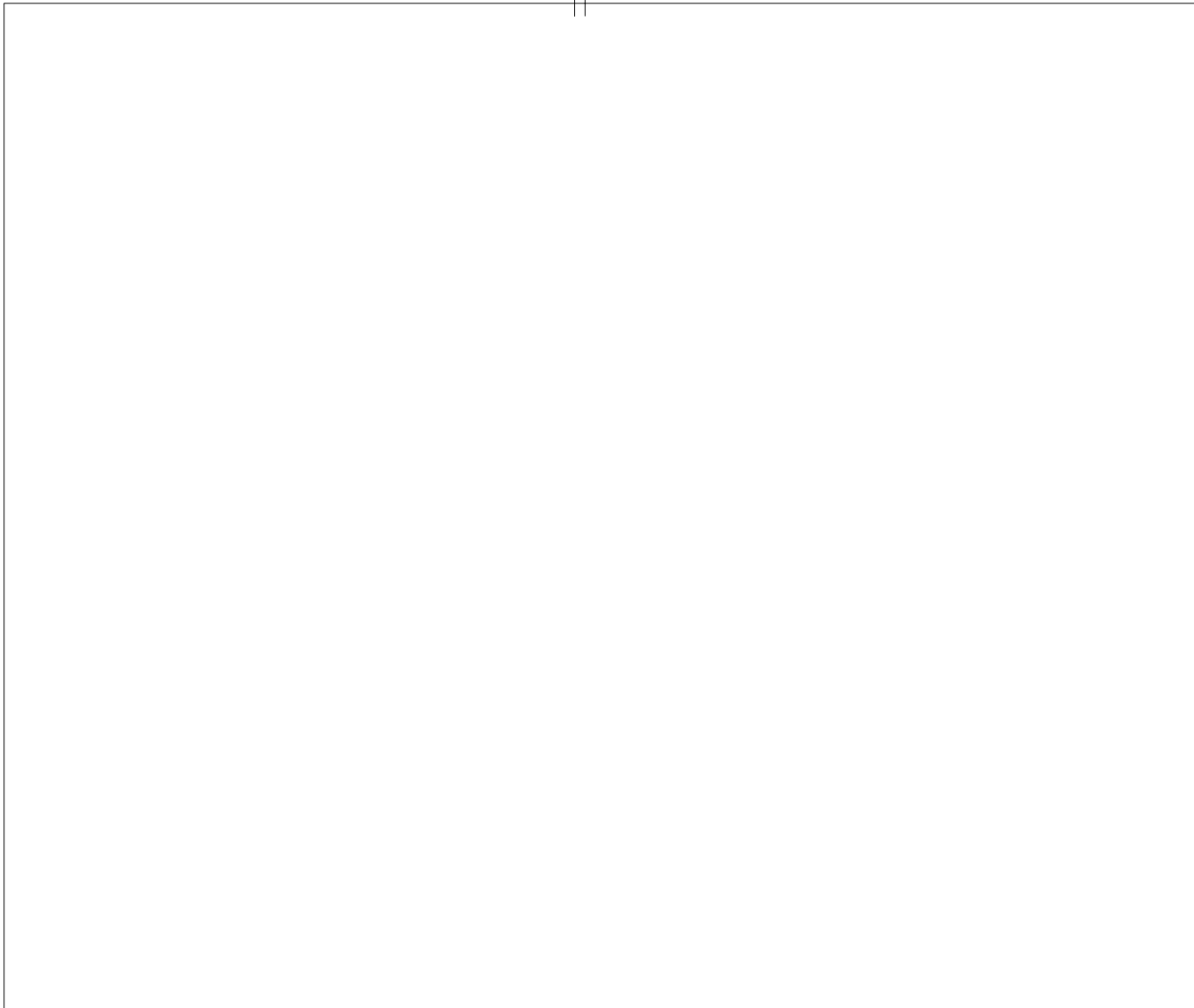

SYMBOLS KEY
|| SCUPPER

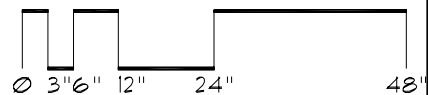

Roof Corrective Action

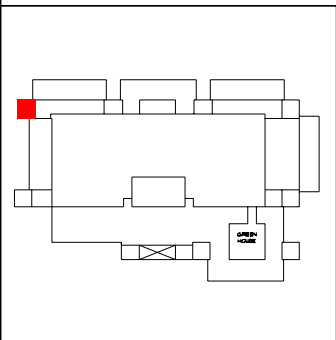
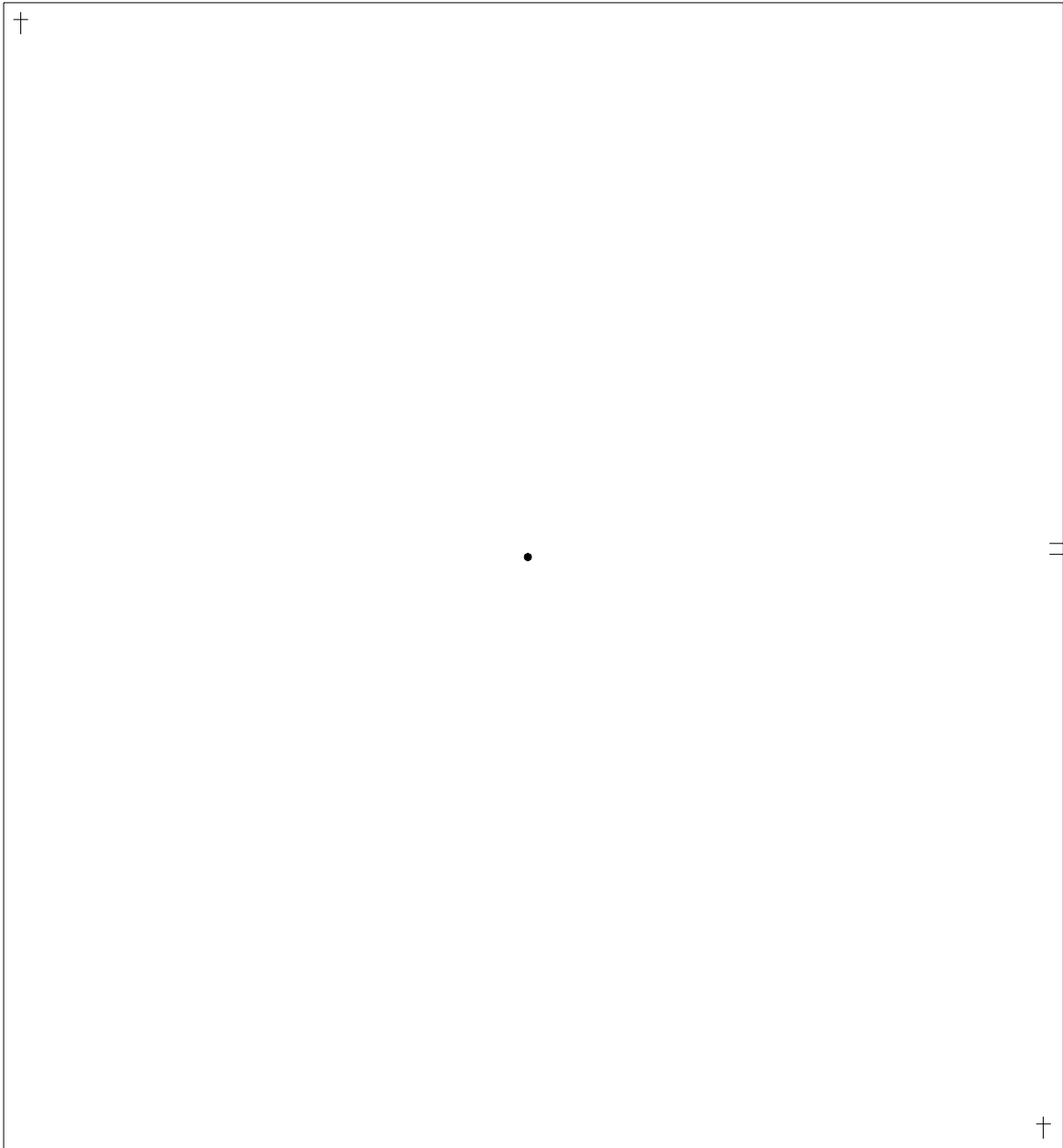

- SYMBOLS KEY
- || OVERFLOW SCUPPER
 - ROOF DRAIN
 - † LIGHTNING PROTECTION

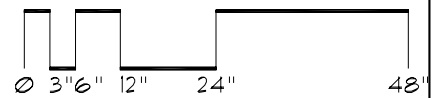

Roof Corrective Action

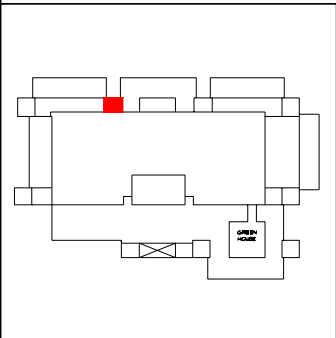
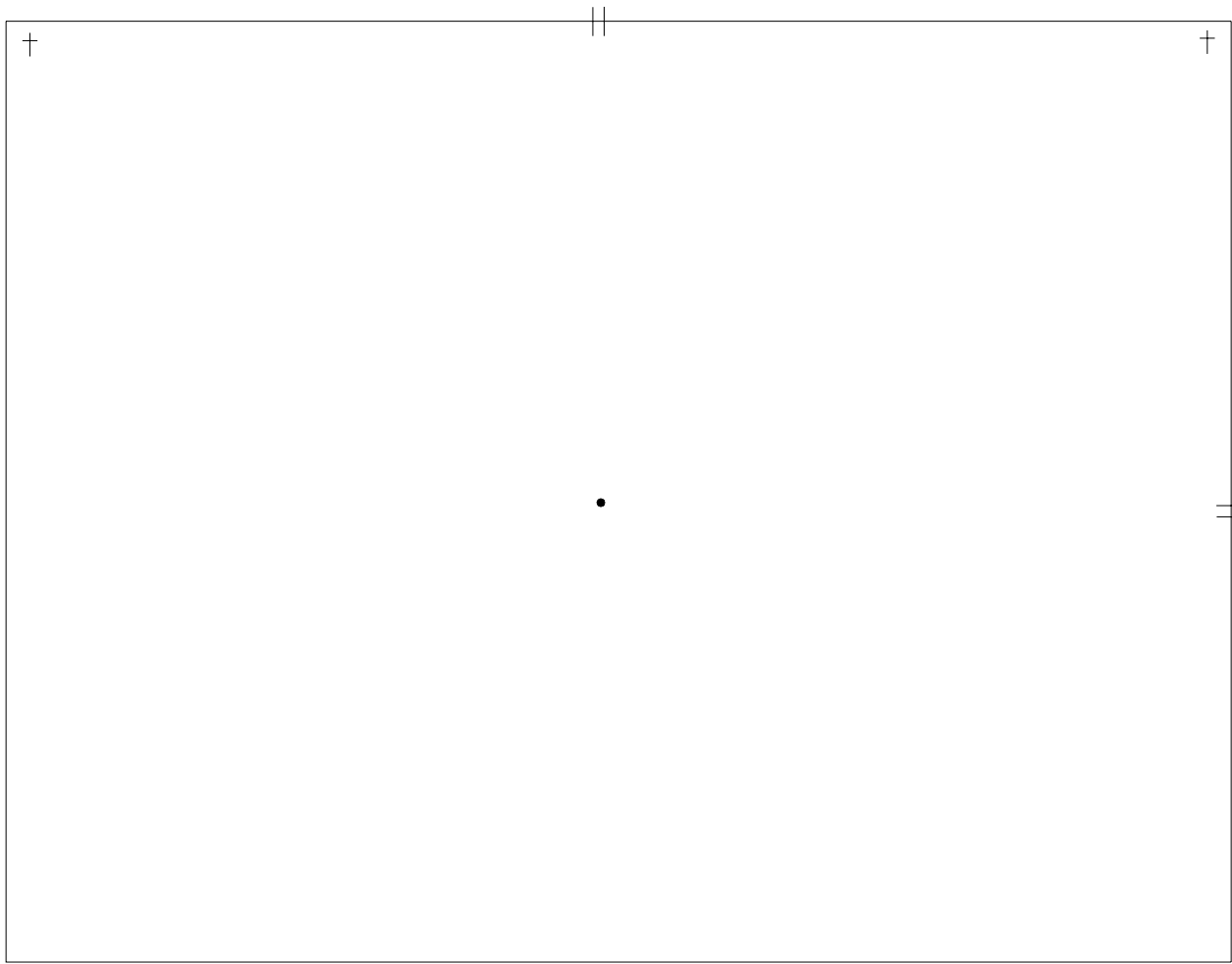

- SYMBOLS KEY**
- ROOF DRAIN
 - † LIGHTNING PROTECTION
 - || OVERFLOW SCUPPER

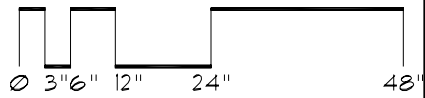
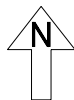

Roof Corrective Action

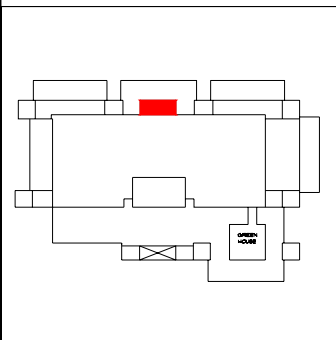
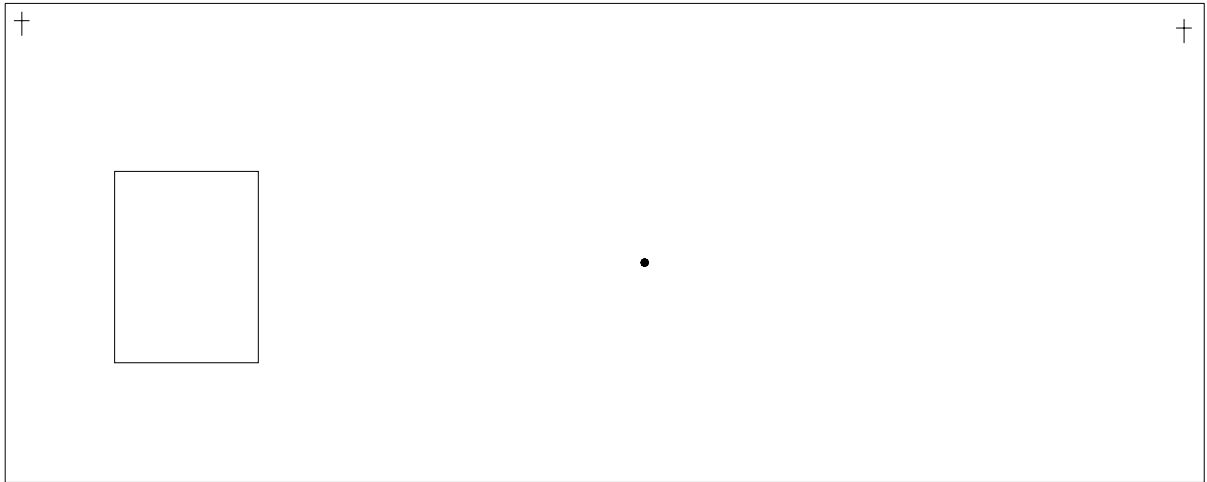

- SYMBOLS KEY
- ROOF DRAIN
 - ROOF CURB
 - † LIGHTNING PROTECTION

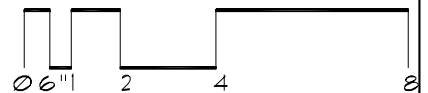

Roof Corrective Action

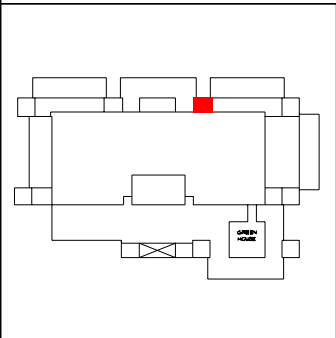
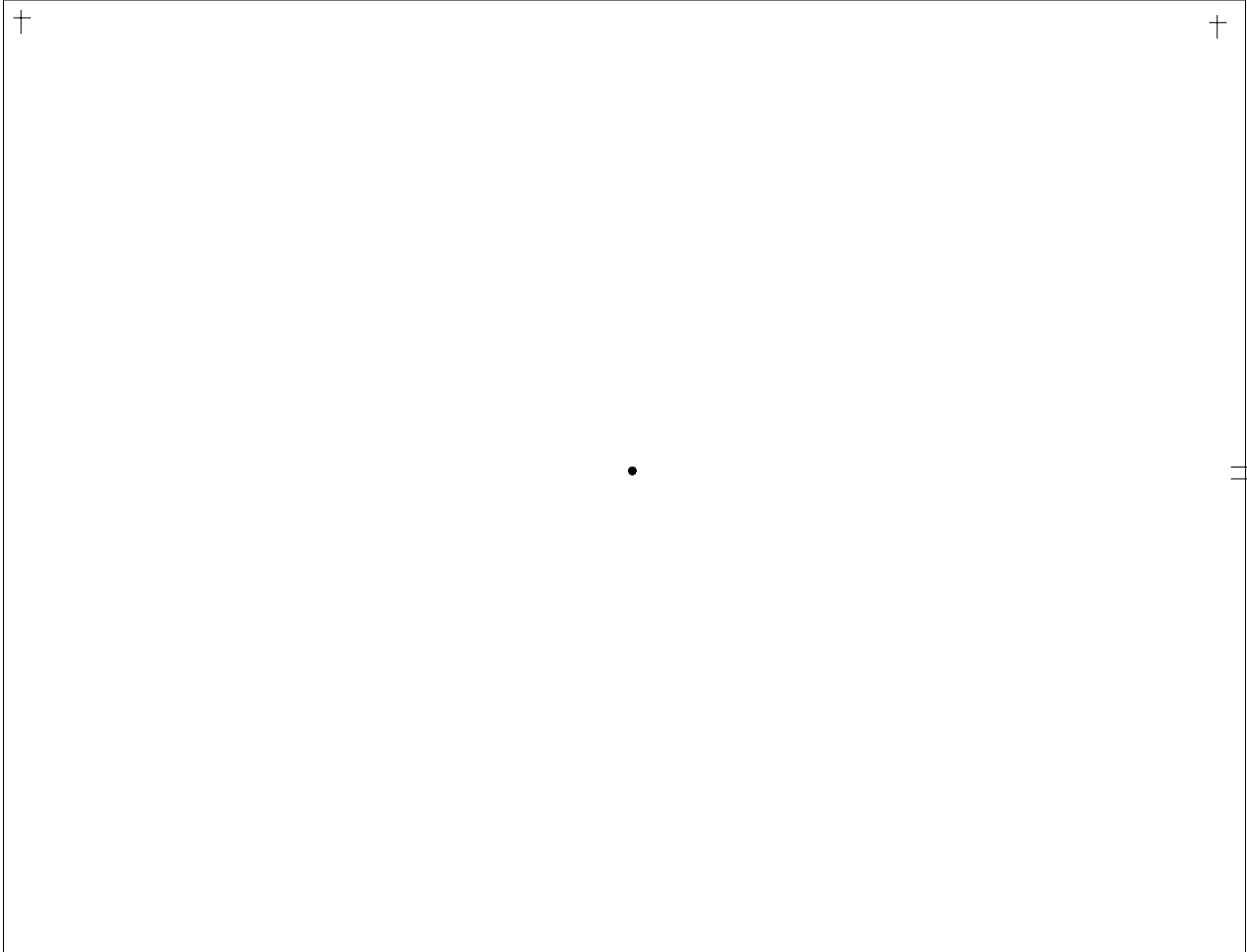

- SYMBOLS KEY
- † SCUPPER
 - ROOF DRAIN
 - † LIGHTNING PROTECTION

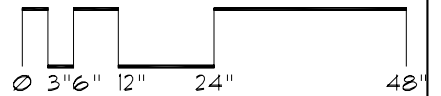

Roof Corrective Action

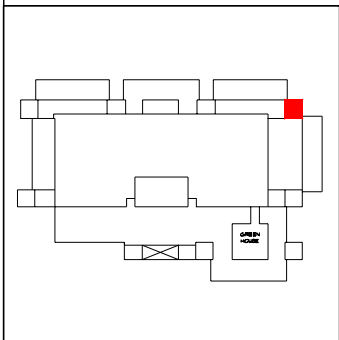
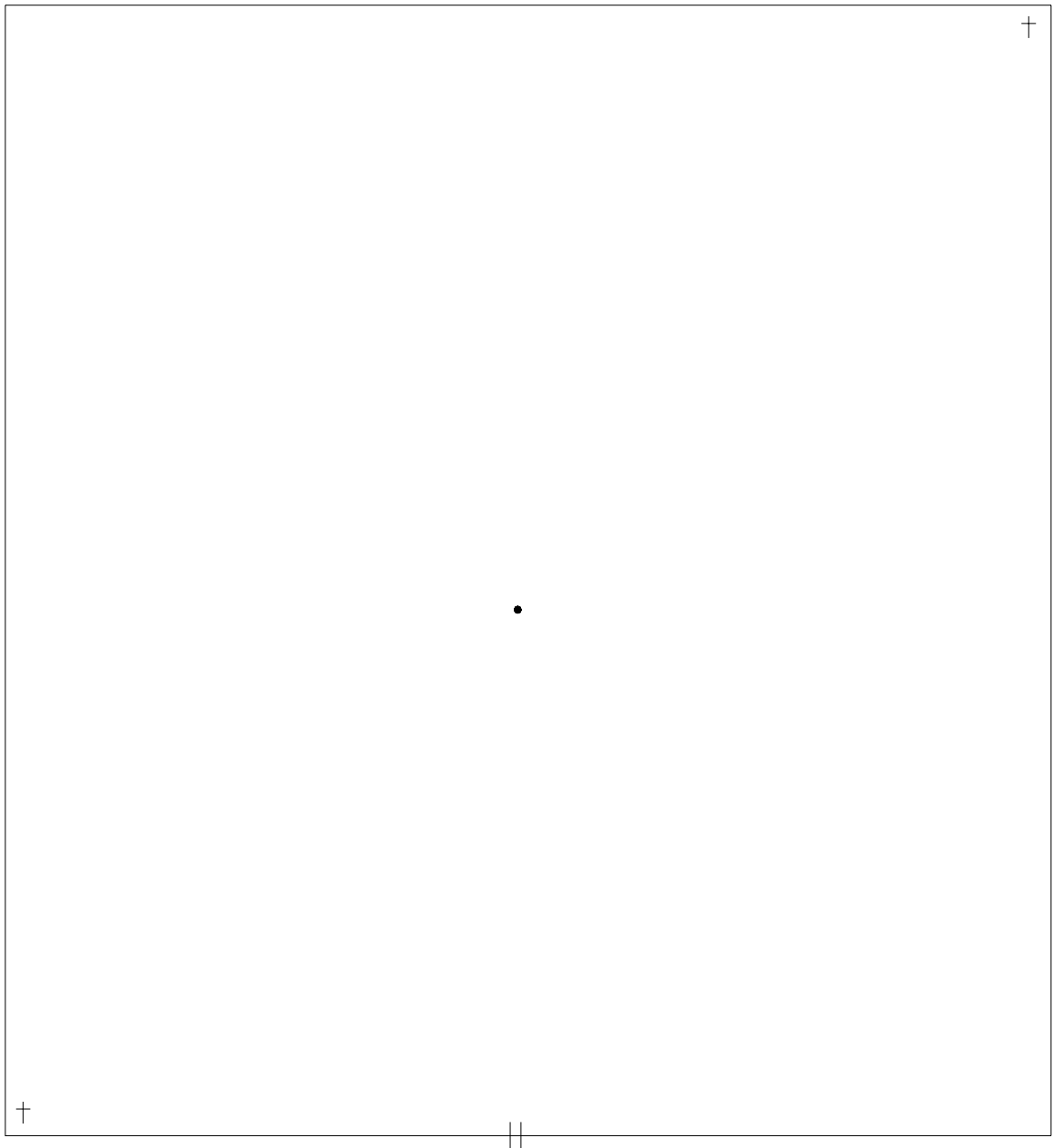

SYMBOLS KEY

- || OVERFLOW SCUPPER
- ROOF DRAIN
- † LIGHTNING PROTECTION

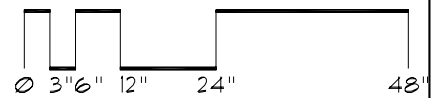

Roof Corrective Action

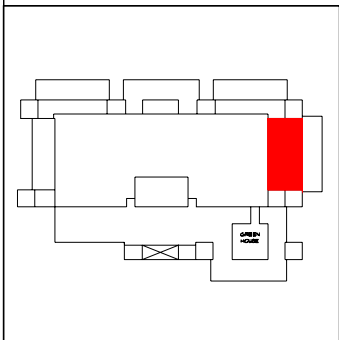
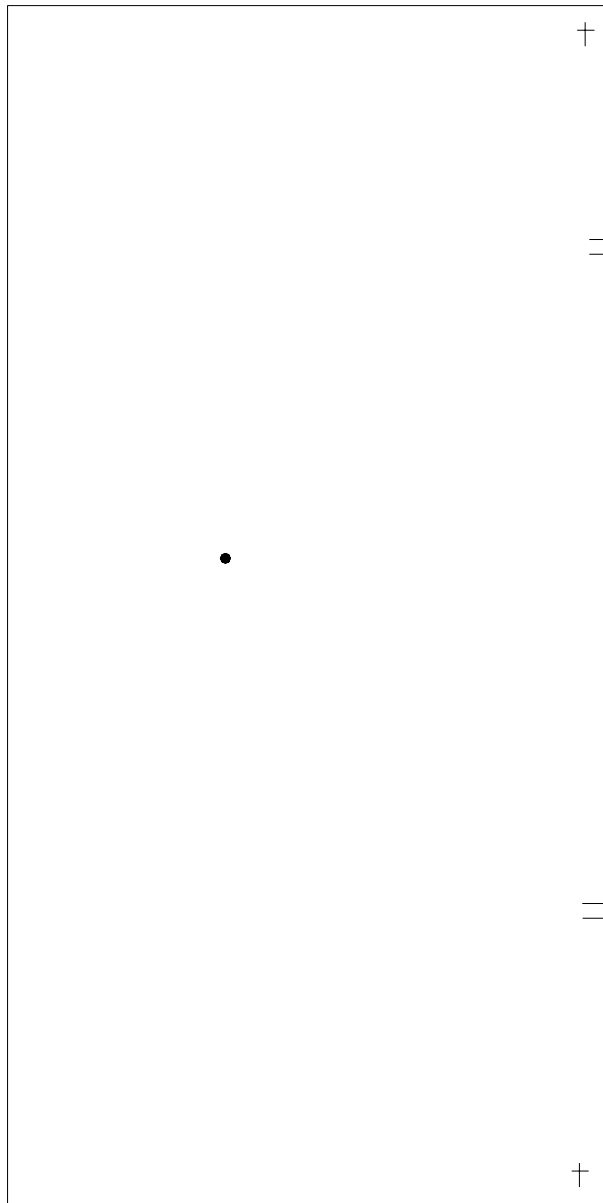

- SYMBOLS KEY**
- ⋈ SCUPPER
 - ROOF DRAIN
 - † LIGHTNING PROTECTION

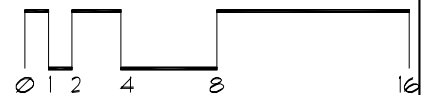
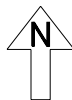

Roof Corrective Action

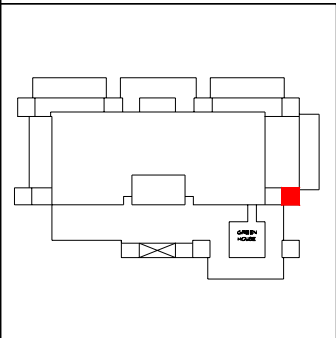
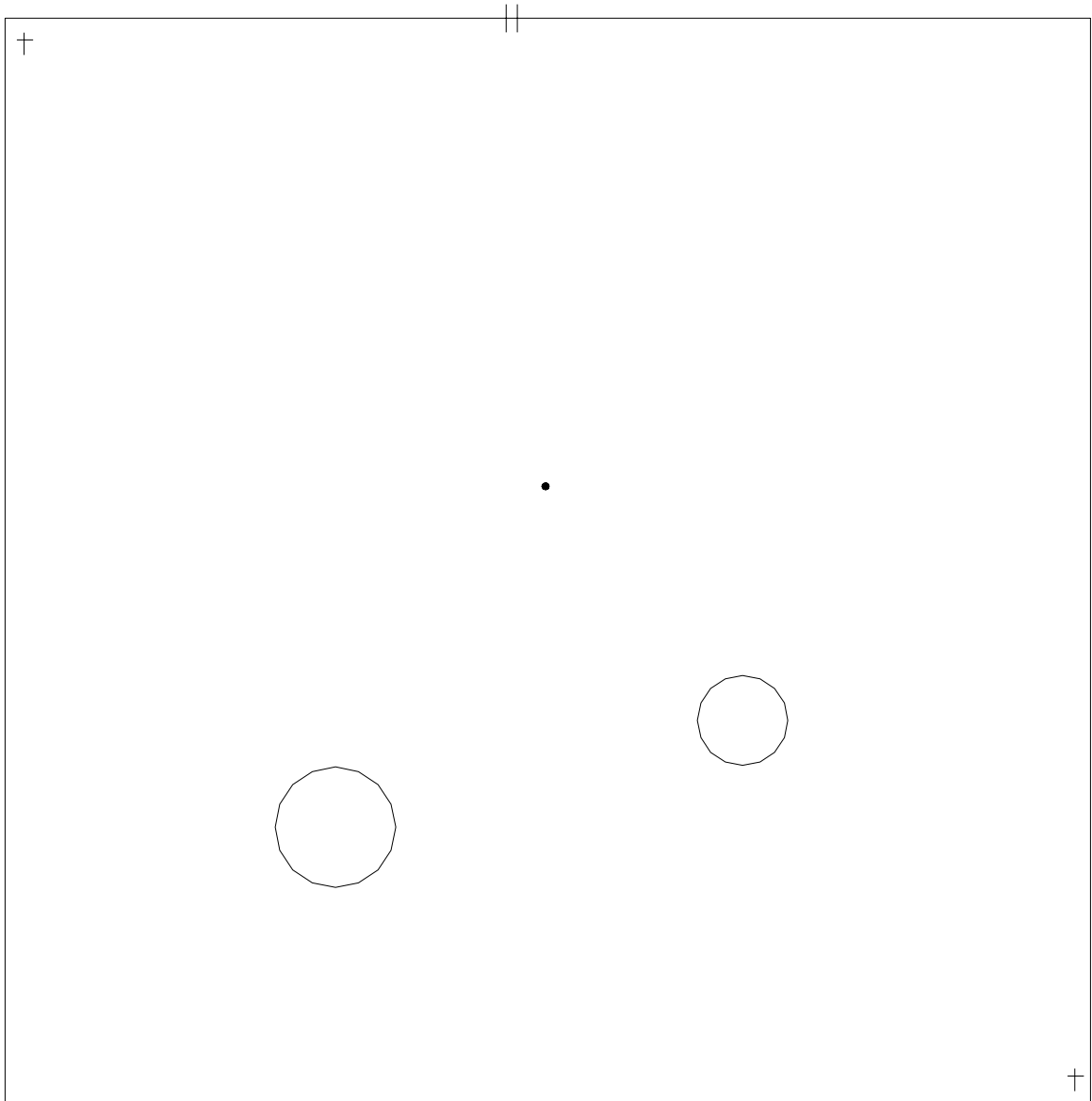

- SYMBOLS KEY**
- || SCUPPER
 - VENT STACK
 - ROOF DRAIN
 - † LIGHTING PROTECTION

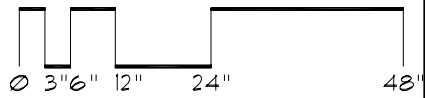
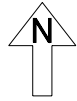

Roof Corrective Action

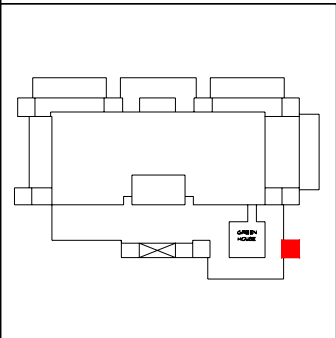
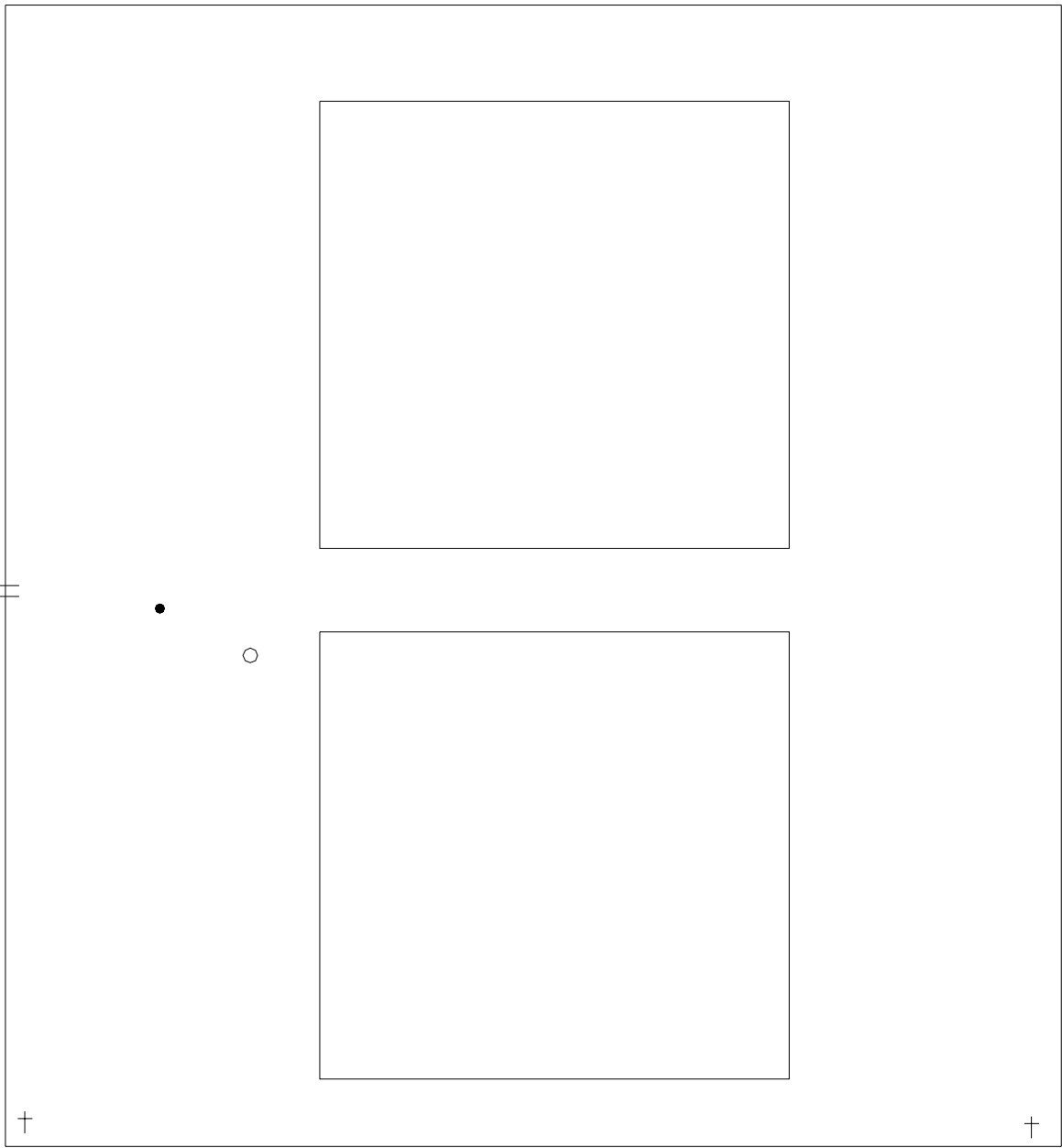

SYMBOLS KEY

- ⋈ SCUPPER
- VENT STACK
- ROOF CURB
- † LIGHTNING PROTECTION
- ROOF DRAIN

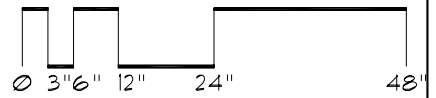

Roof Corrective Action

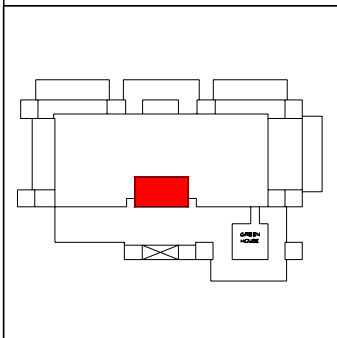
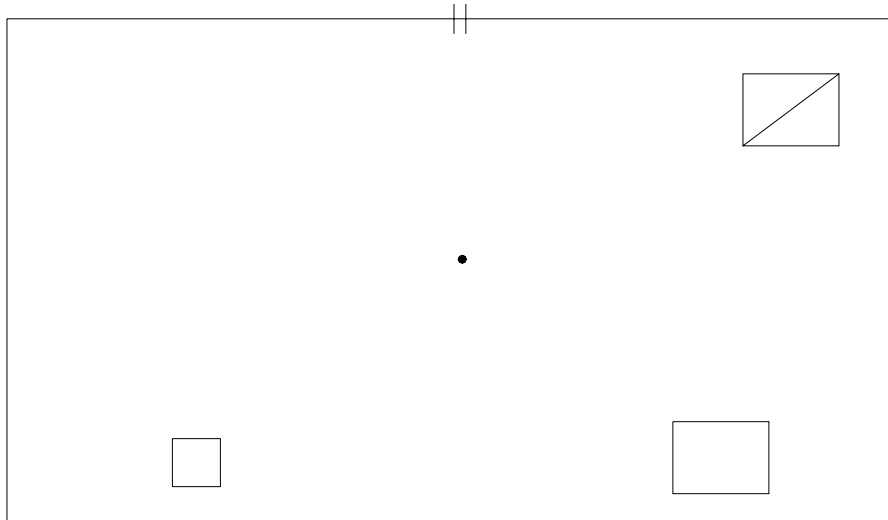

SYMBOLS KEY

- || SCUPPER
- ROOF DRAIN
- ROOF CURB
- ▣ ROOF HATCH
- † LIGHTING PROTECTION

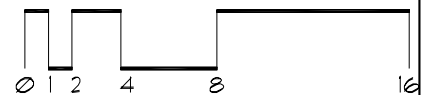

Roof Corrective Action

SYMBOLS KEY

- ⊥ THROUGH CJ OVERFLOW SCUPPER
- VENT STACK
- ROOF DRAIN
- ROOF CURB
- ⊞ PITCH PAN
- † LIGHTNING PROTECTION
- Ⓡ DEFECT-REPAIR
- Ⓢ DEFECT-NO REPAIR

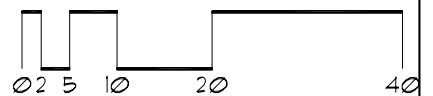
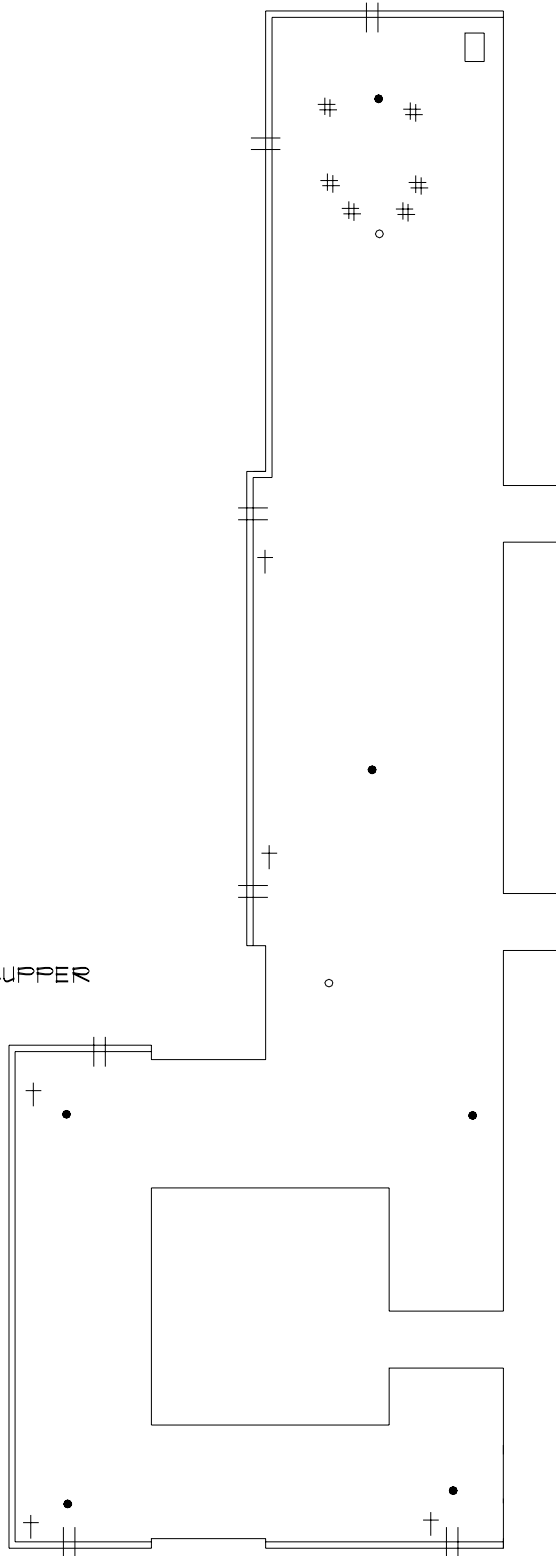
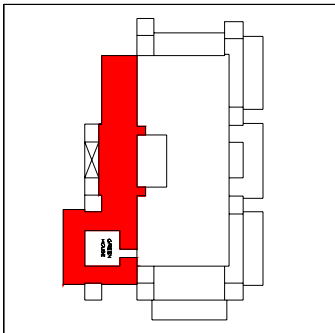

Roof Corrective Action

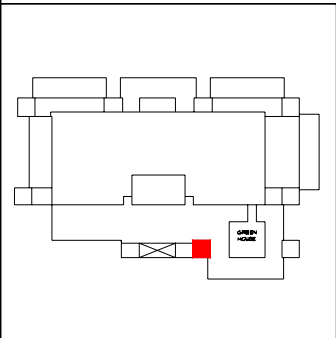
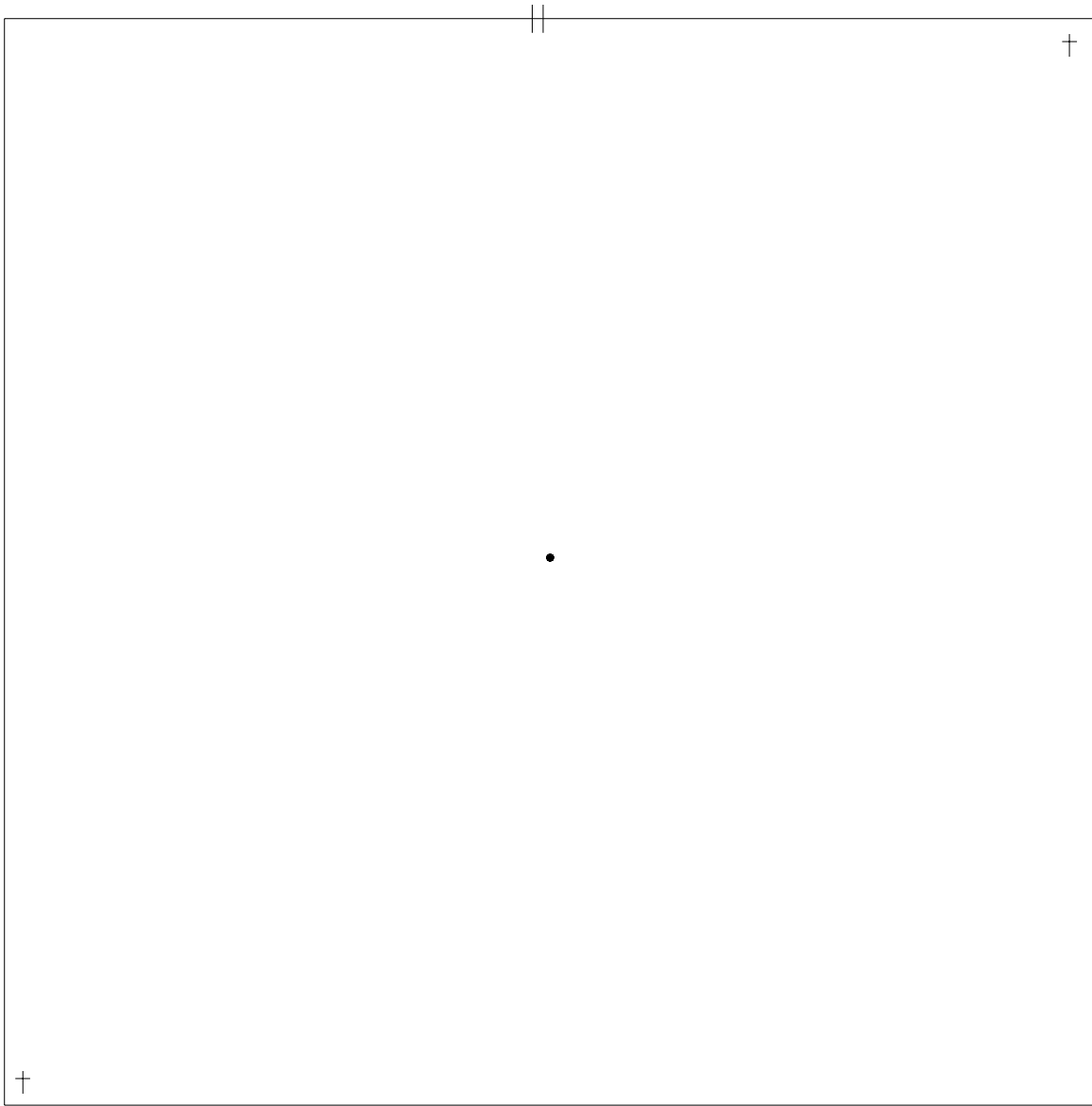

SYMBOLS KEY

- || THROUGH CJ OVERFLOW SCUPPER
- ROOF DRAIN
- † LIGHTNING PROTECTION

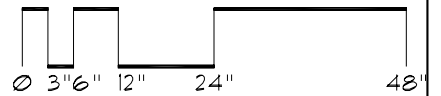

Roof Corrective Action

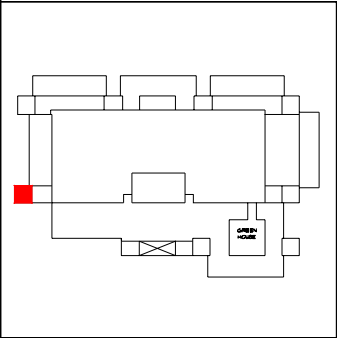
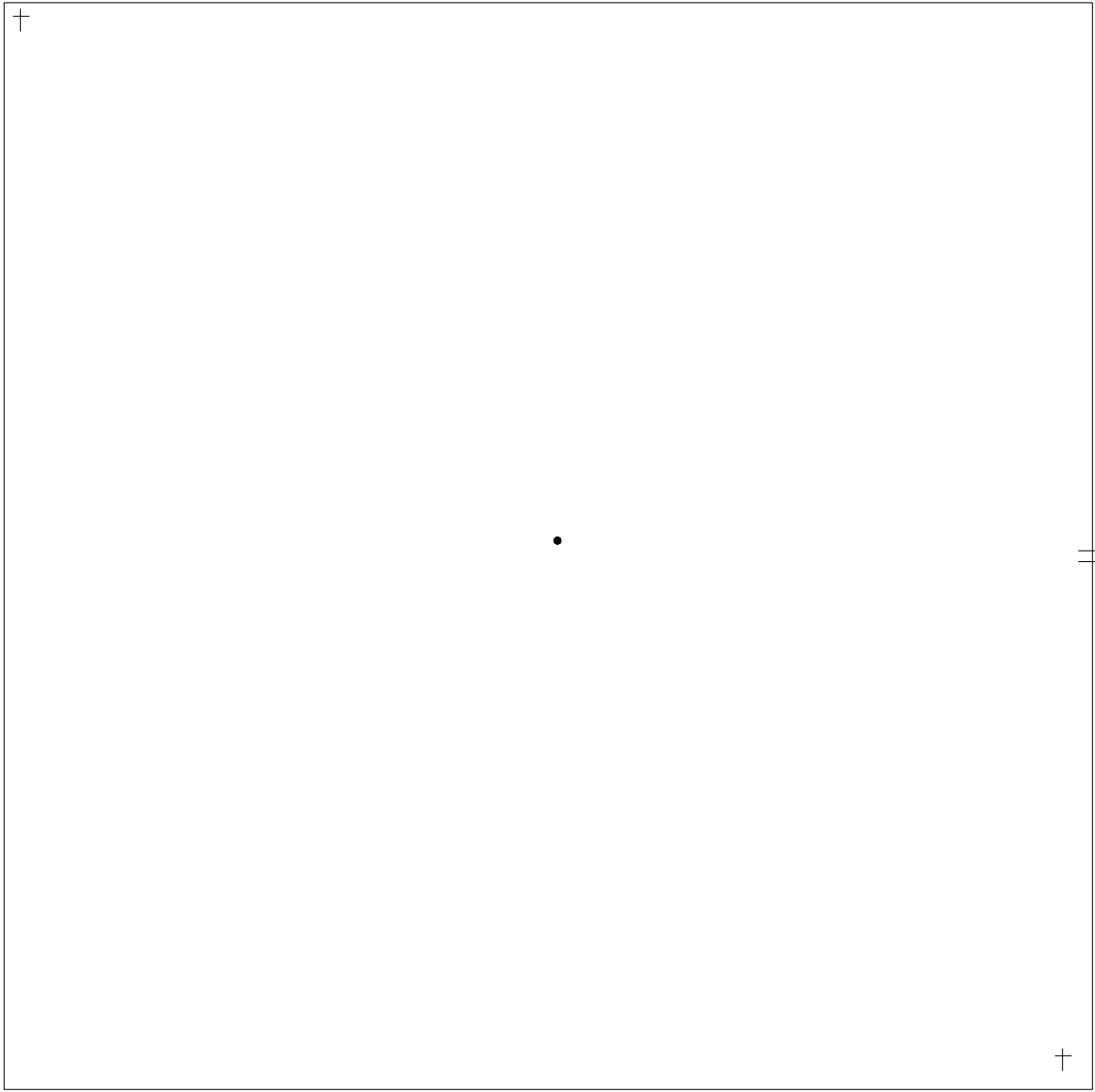

SYMBOLS KEY

- ⊥ THROUGH CJ OVERFLOW SCUPPER
- ROOF DRAIN
- † LIGHTNING PROTECTION

↑ N

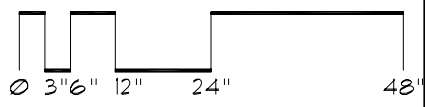

Roof Corrective Action

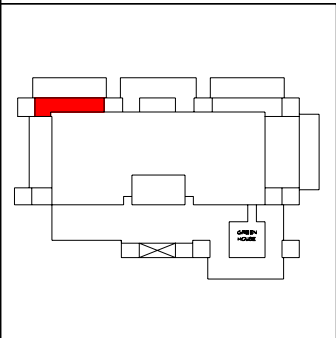
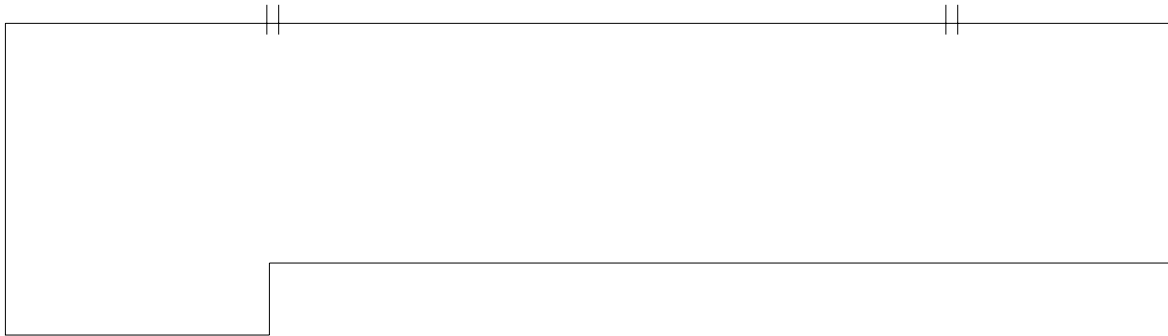

SYMBOLS KEY
|| SCUPPER

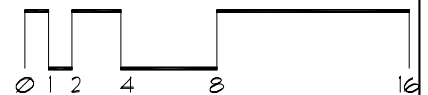

Roof Corrective Action

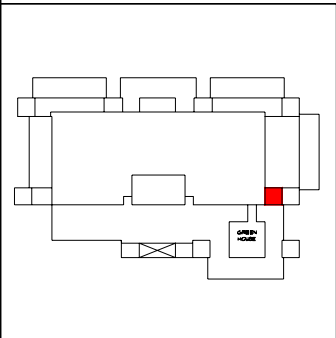
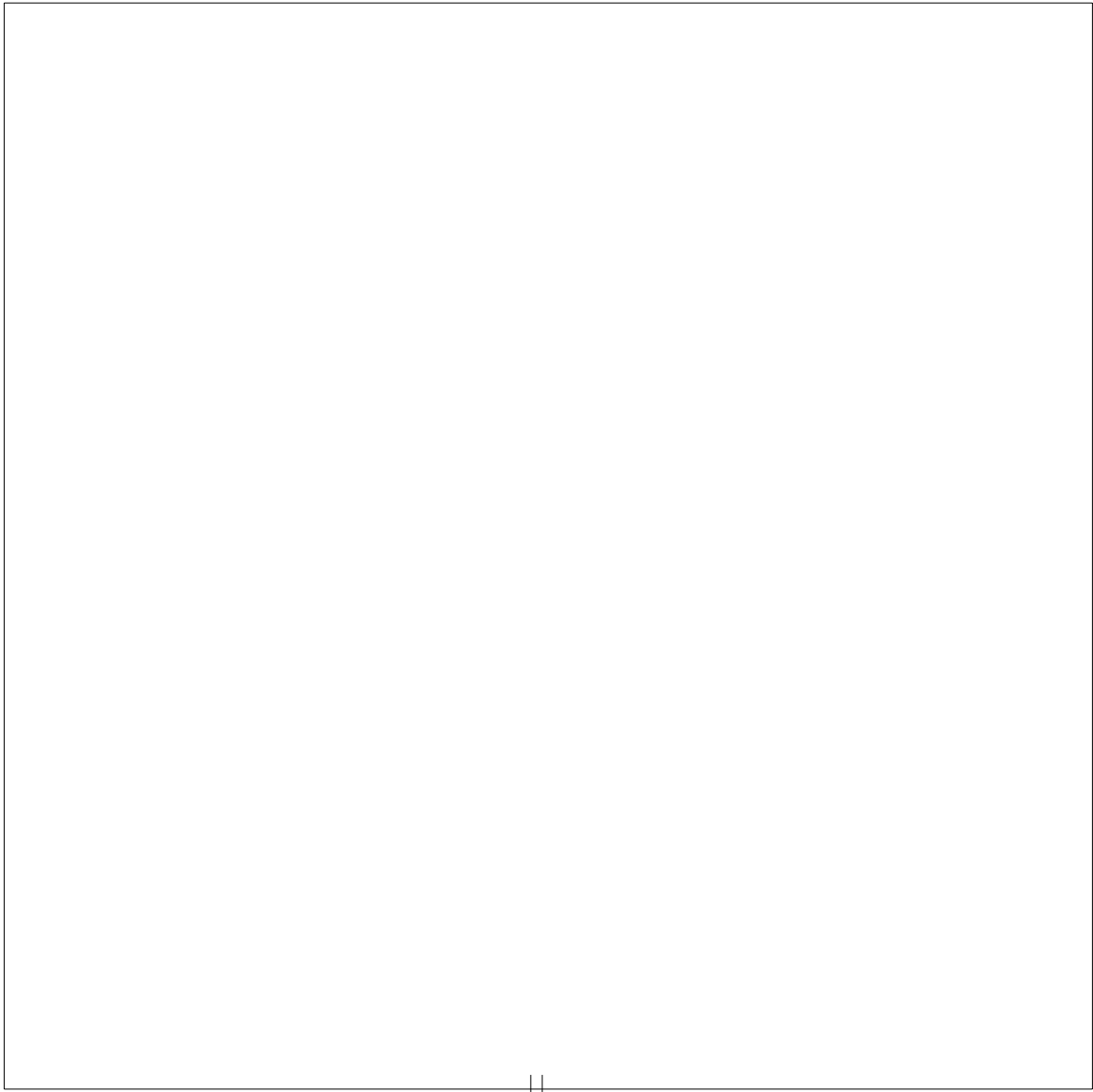

SYMBOLS KEY
|| SCUPPER

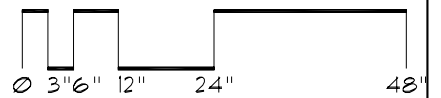
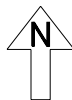

Roof Corrective Action

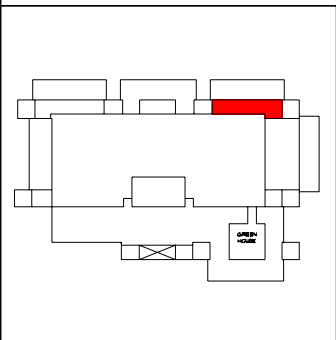
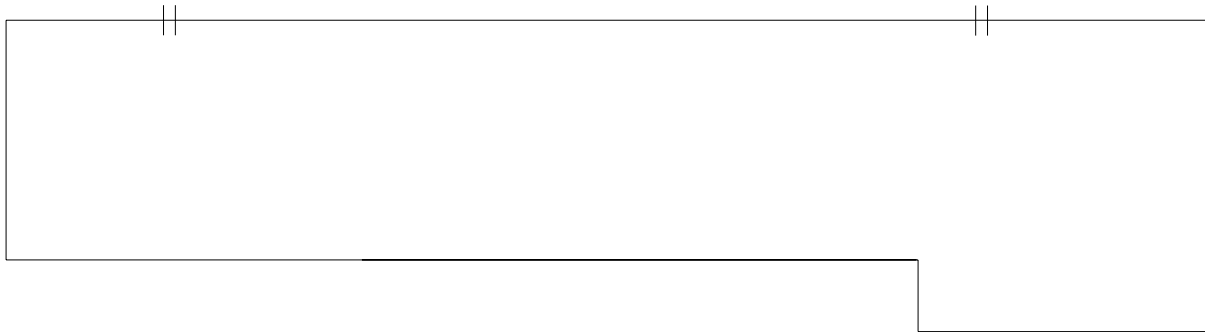

SYMBOLS KEY
|| SCUPPER

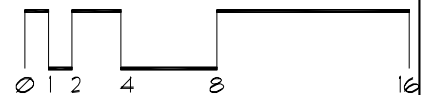

Roof Corrective Action

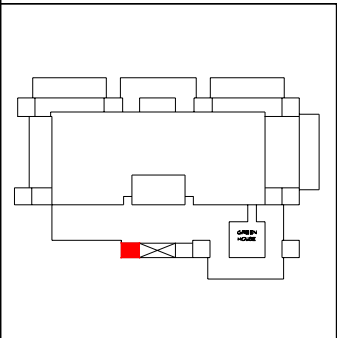
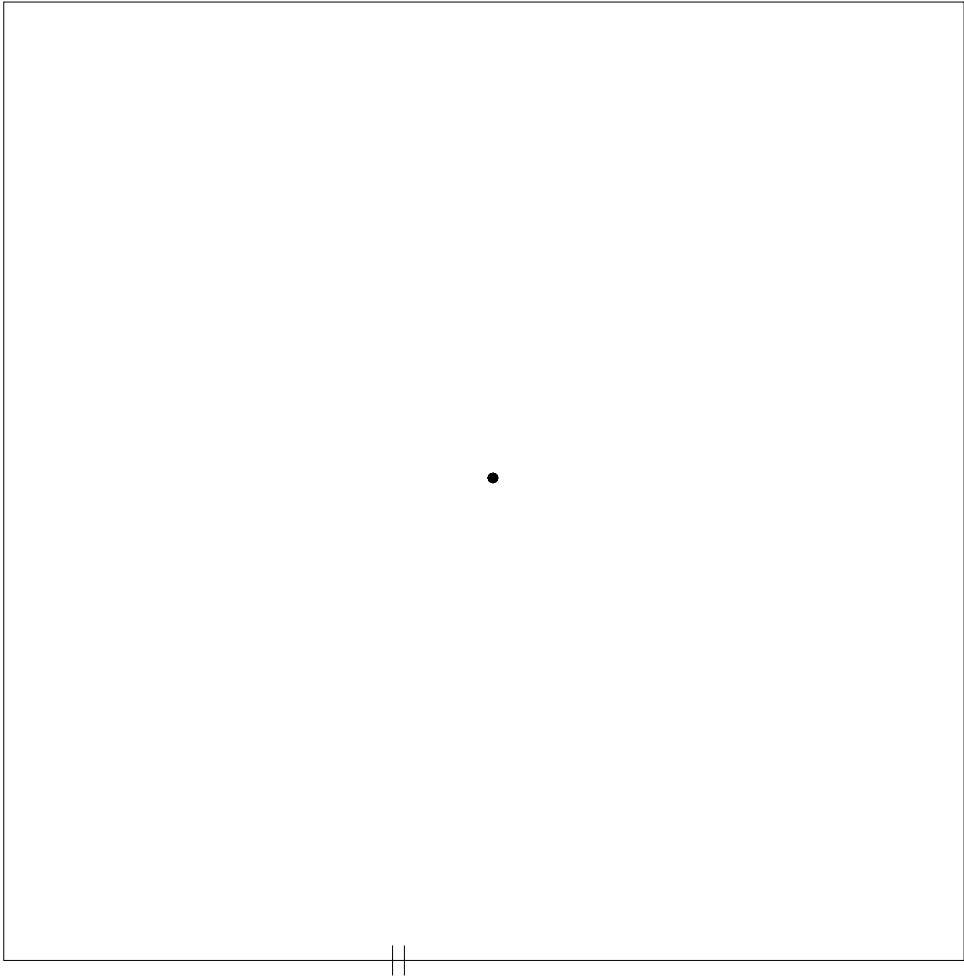

SYMBOLS KEY
● ROOF DRAIN
|| SCUPPER

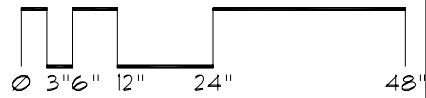

Roof Corrective Action

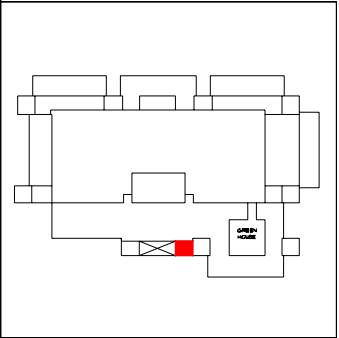
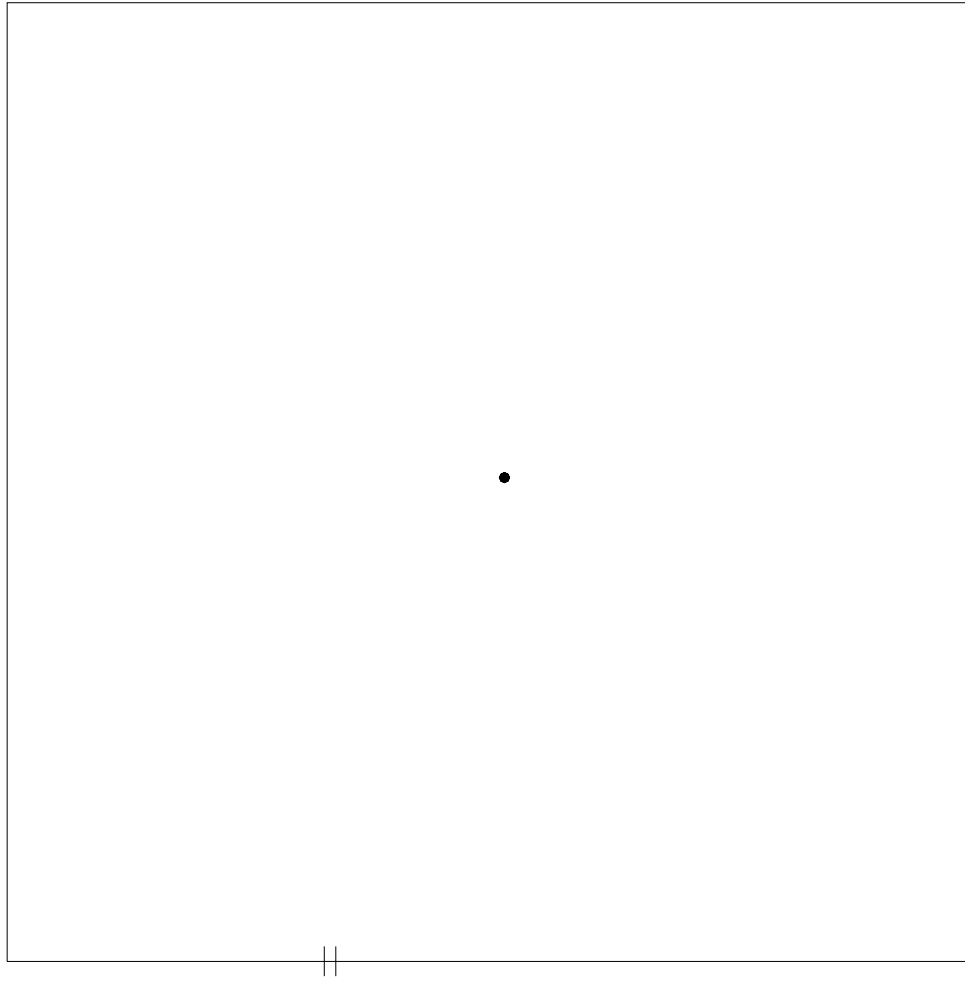

SYMBOLS KEY
● ROOF DRAIN
|| SCUPPER

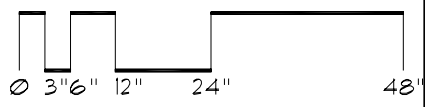

Roof ID

Building: EB172 - Weisman Art Museum - (333 East River Road Mpls)

Roof Access: North stairwell by elevator

Total Area: 21,181 sf

<u>A</u>	<u>3,570</u>	<u>E</u>	<u>756</u>	<u>I</u>	<u>2,168</u>
<u>B</u>	<u>720</u>	<u>F</u>	<u>322</u>	<u>J</u>	<u>484</u>
<u>C</u>	<u>2,545</u>	<u>G</u>	<u>340</u>		
<u>D</u>	<u>7,240</u>	<u>H</u>	<u>3,036</u>		

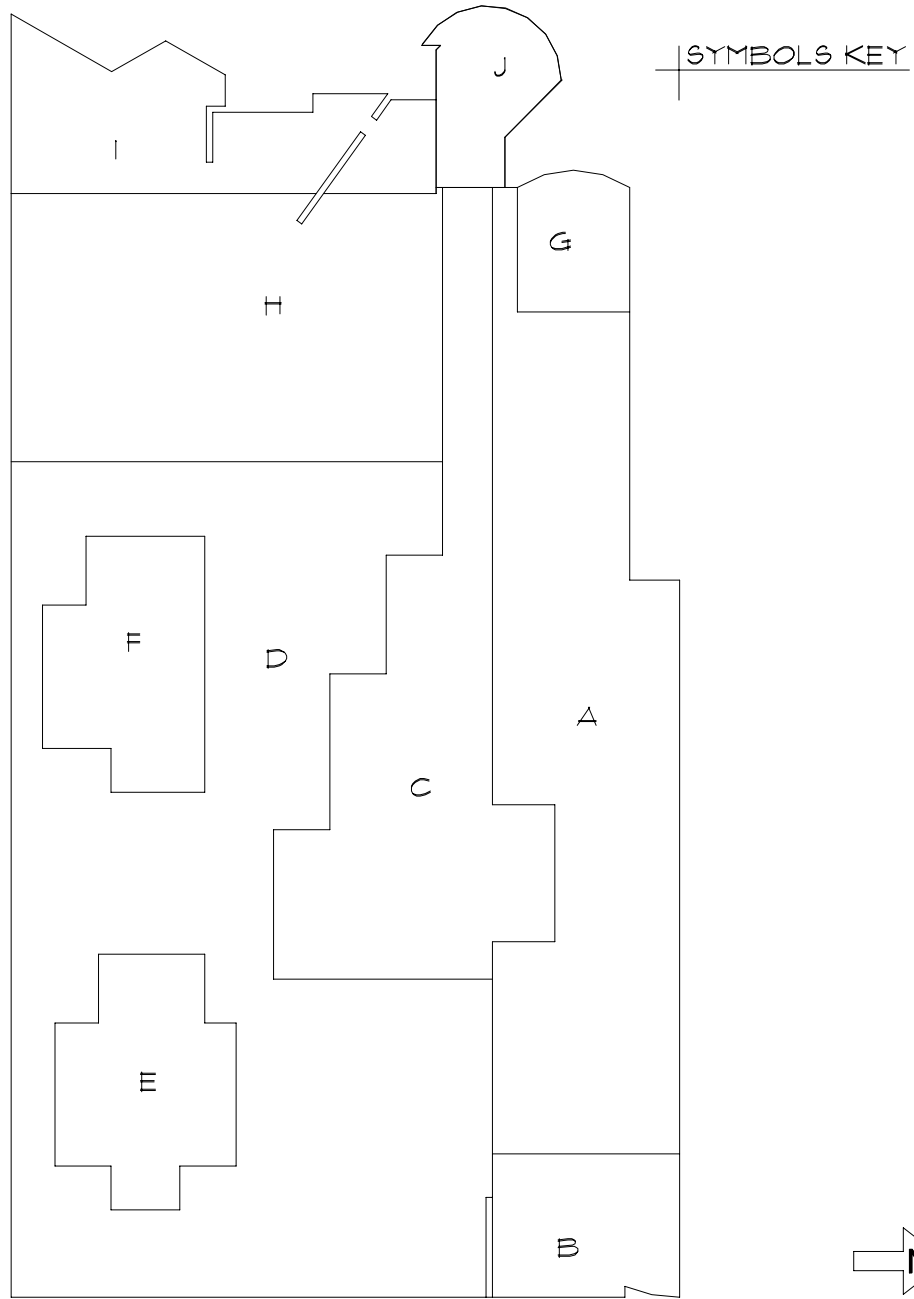

Roof Corrective Action

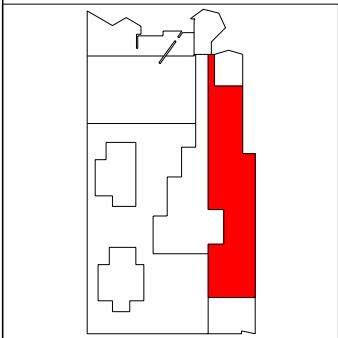
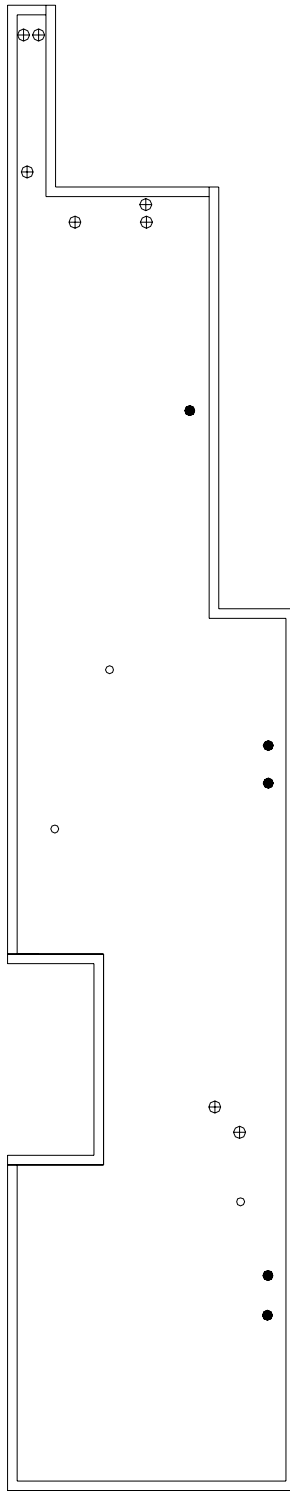

- SYMBOLS KEY**
- ROOF DRAIN
 - VENT STACK
 - ⊕ FLASHED PEN.

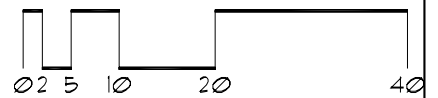

Roof Corrective Action

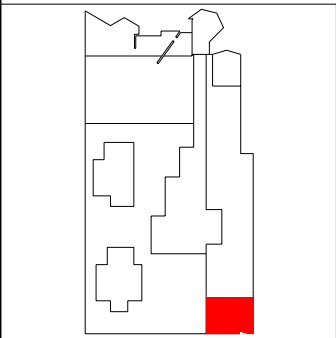
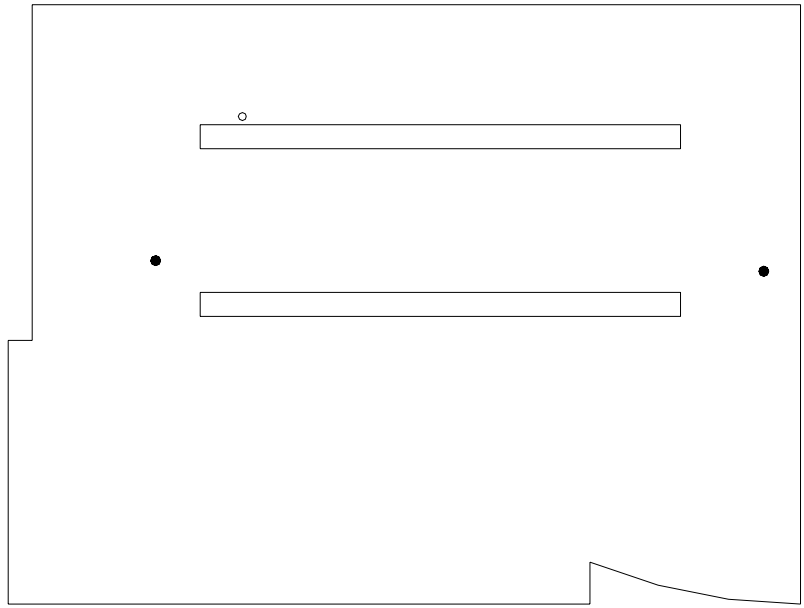

- SYMBOLS KEY**
- ROOF CURB
 - ROOF DRAIN
 - VENT STACK

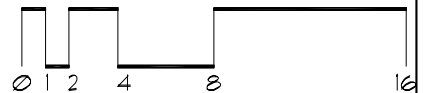
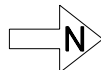

Roof Corrective Action

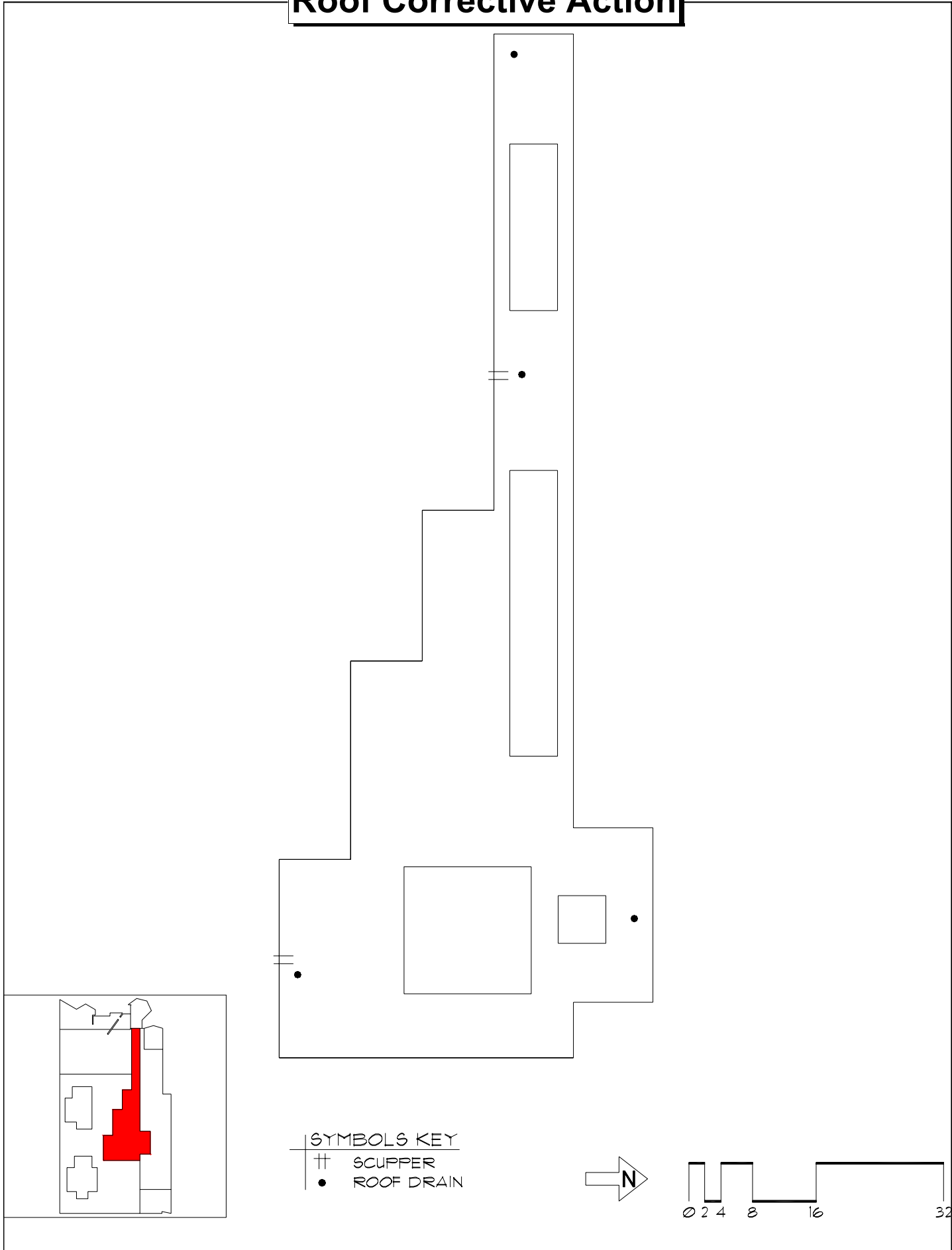

SYMBOLS KEY
|| SCUPPER
● ROOF DRAIN

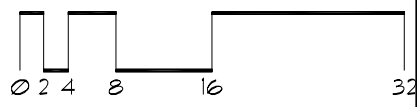
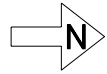

Roof Corrective Action

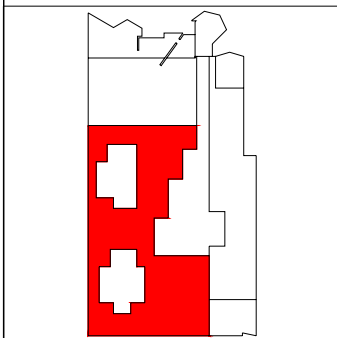
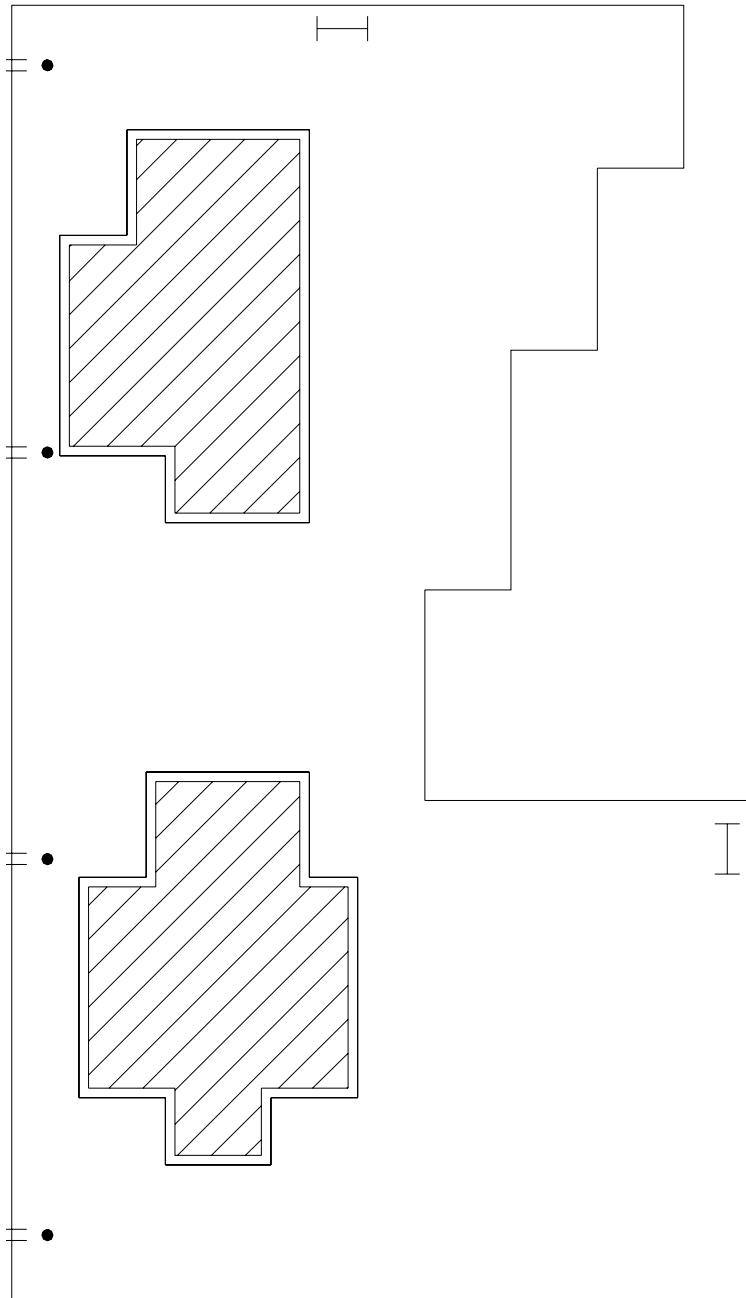

SYMBOLS KEY

- || SCUPPER
- ROOF DRAIN
- H LADDER

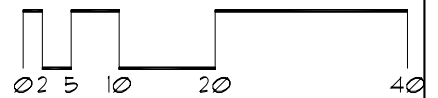

Roof Corrective Action

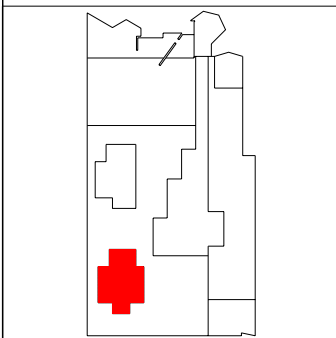
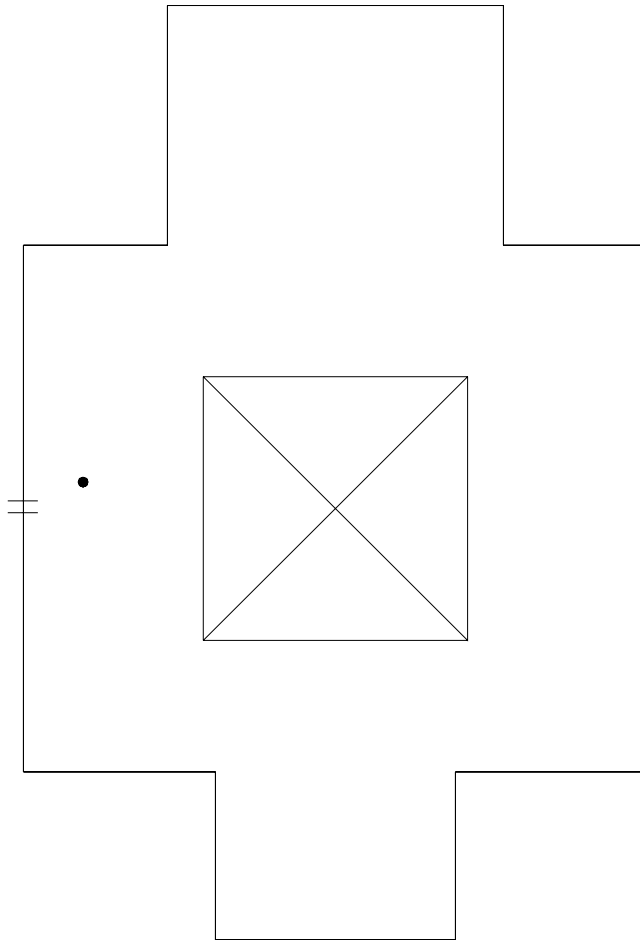

SYMBOLS KEY

- ROOF DRAIN
- ≡ SCUPPER
- ☒ SKYLIGHT

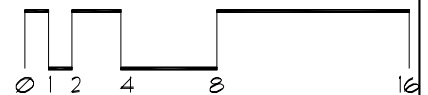

Roof Corrective Action

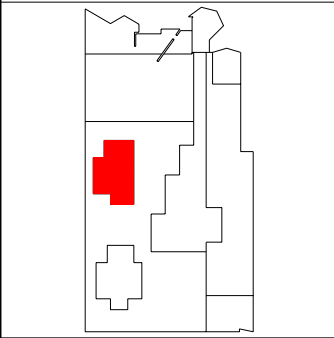
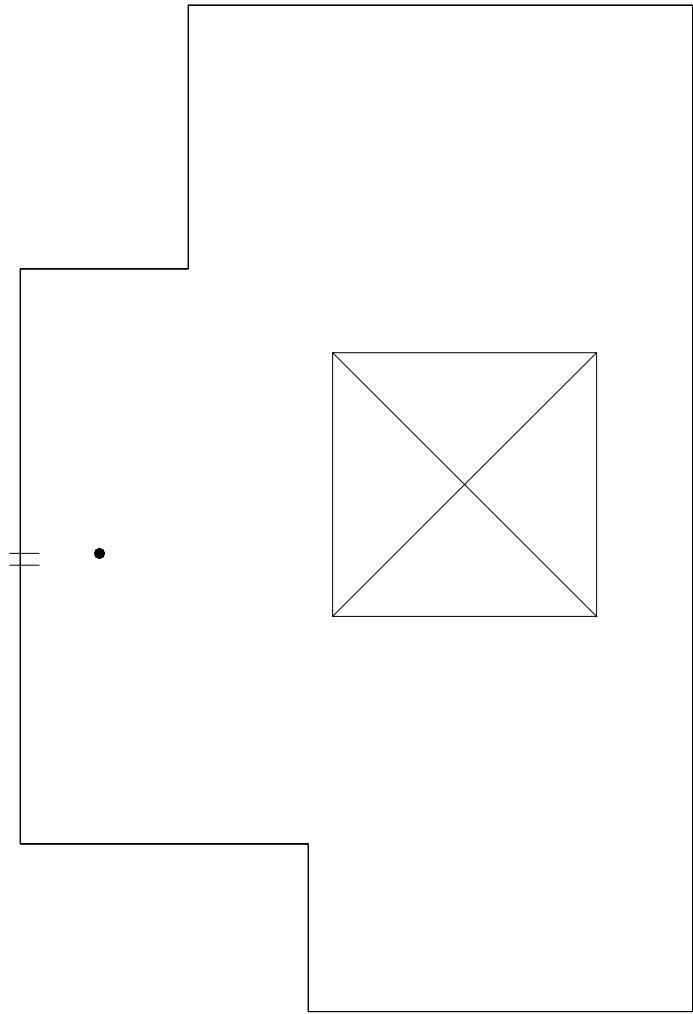

SYMBOLS KEY

⊥	SCUPPER
●	ROOF DRAIN
☒	SKYLIGHT

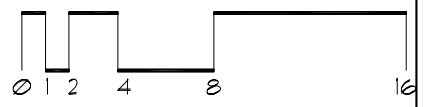

Roof Corrective Action

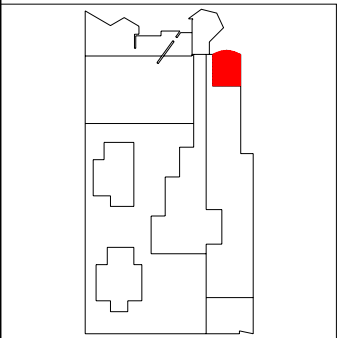
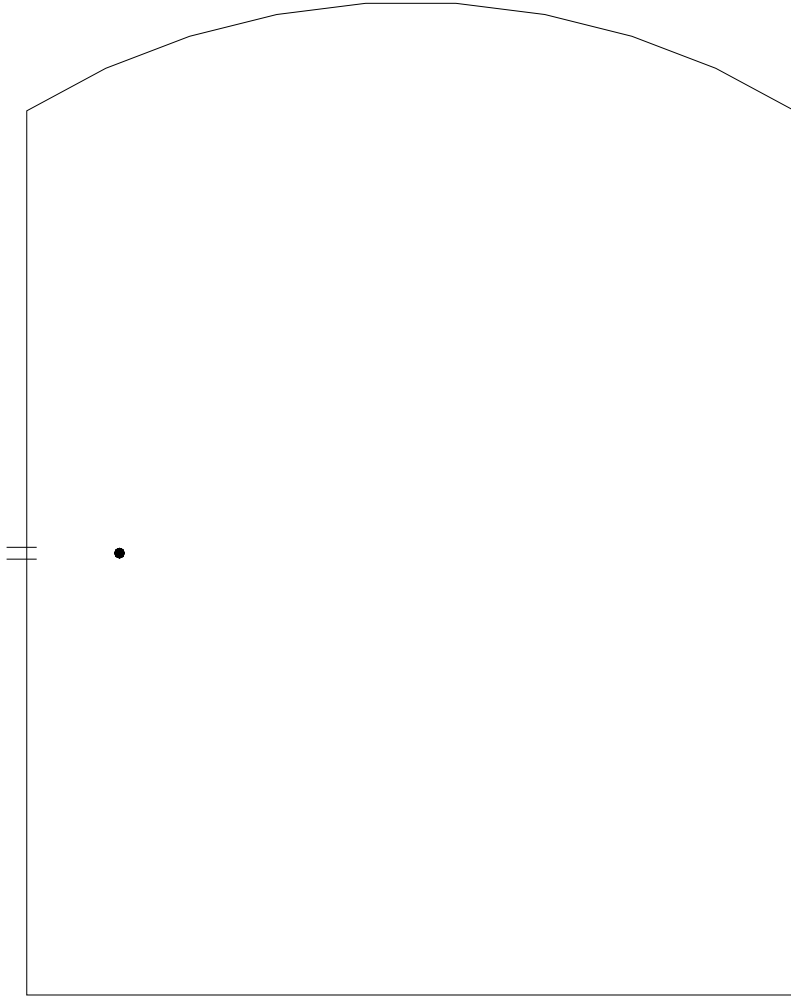

SYMBOLS KEY
● ROOF DRAIN
|| SCUPPER

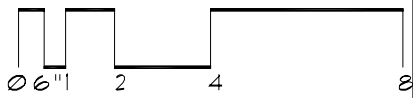

Roof Corrective Action

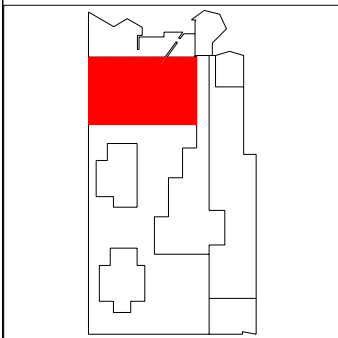
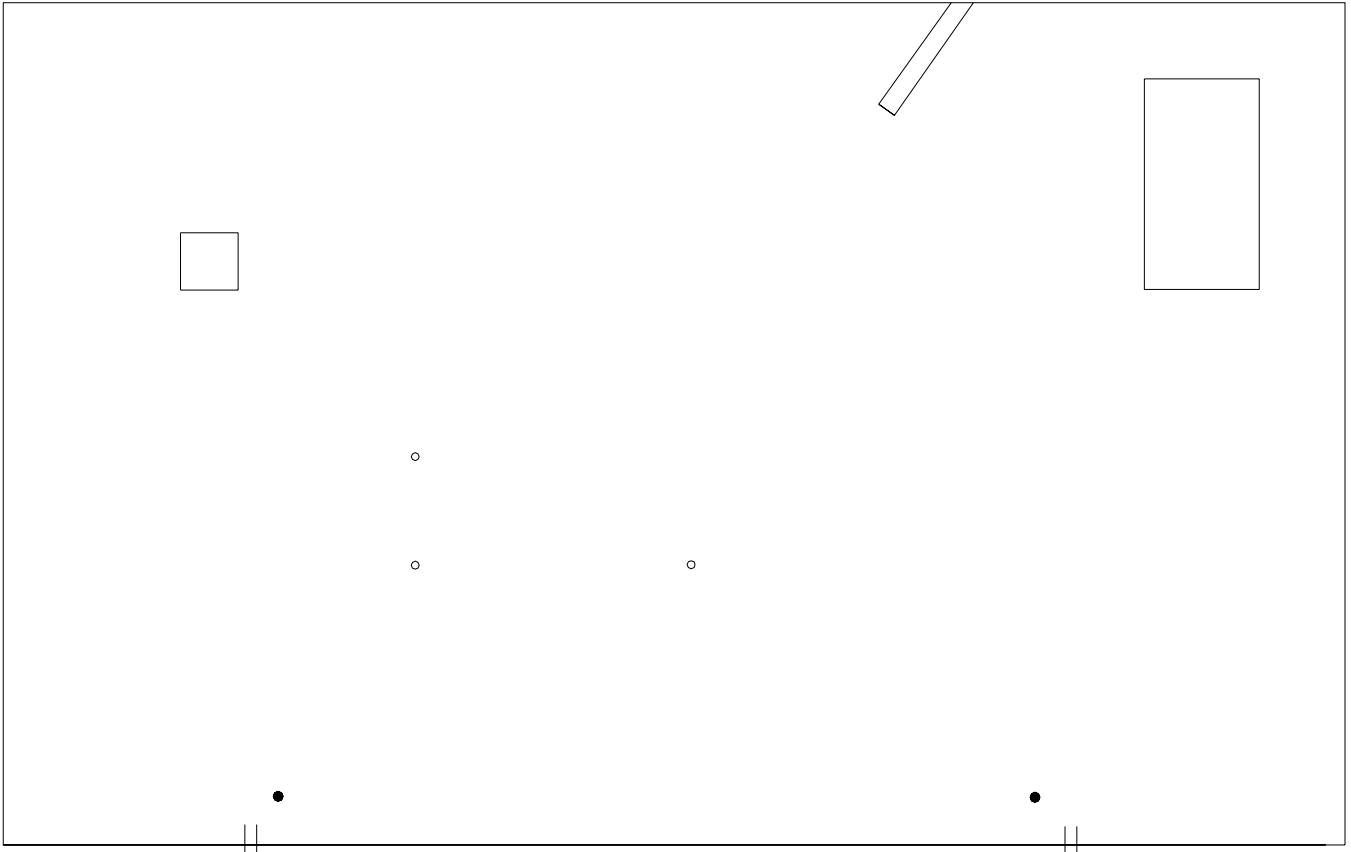

SYMBOLS KEY

⊥	SCUPPER
○	VENT STACK
●	ROOF DRAIN
□	ROOF CURB

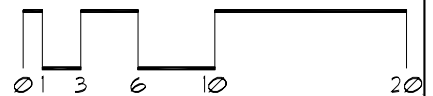

Roof Corrective Action

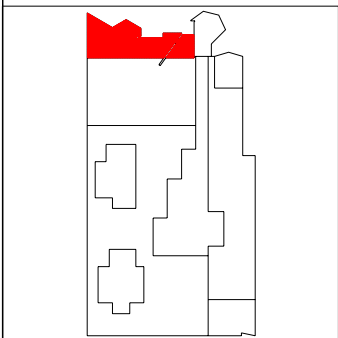
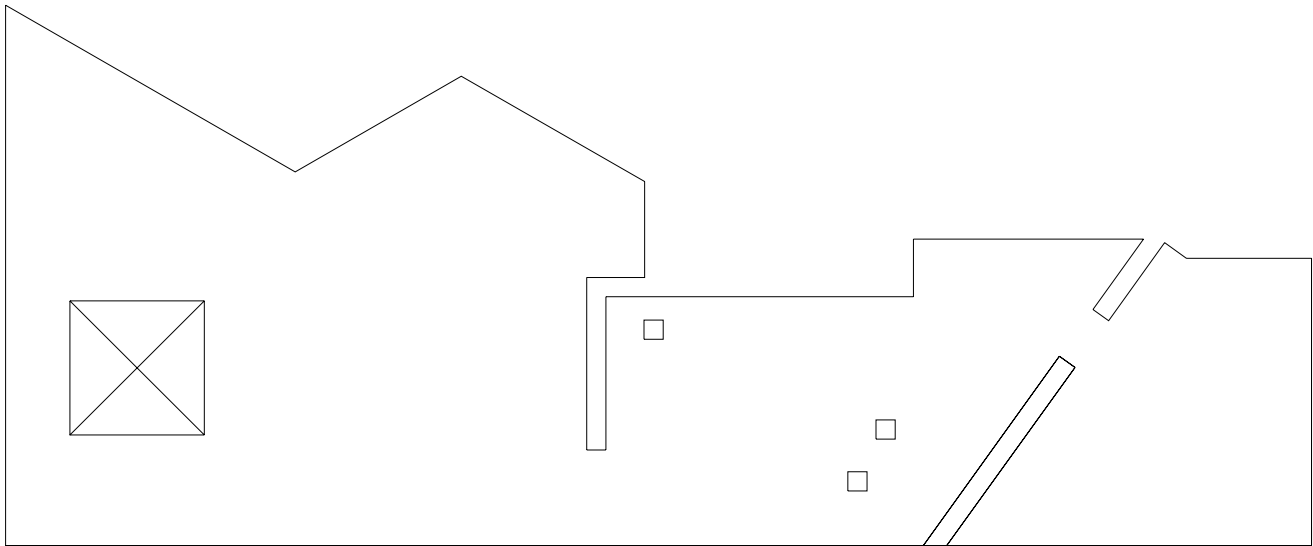

SYMBOLS KEY
□ ROOF CURB
☒ SKYLIGHT

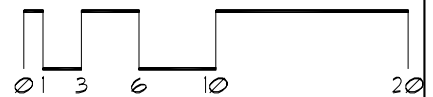

Roof Corrective Action

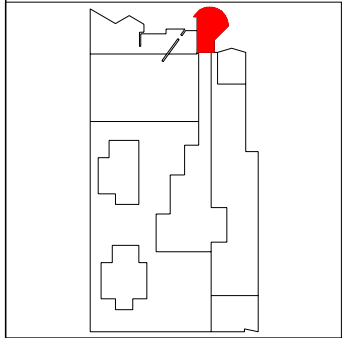
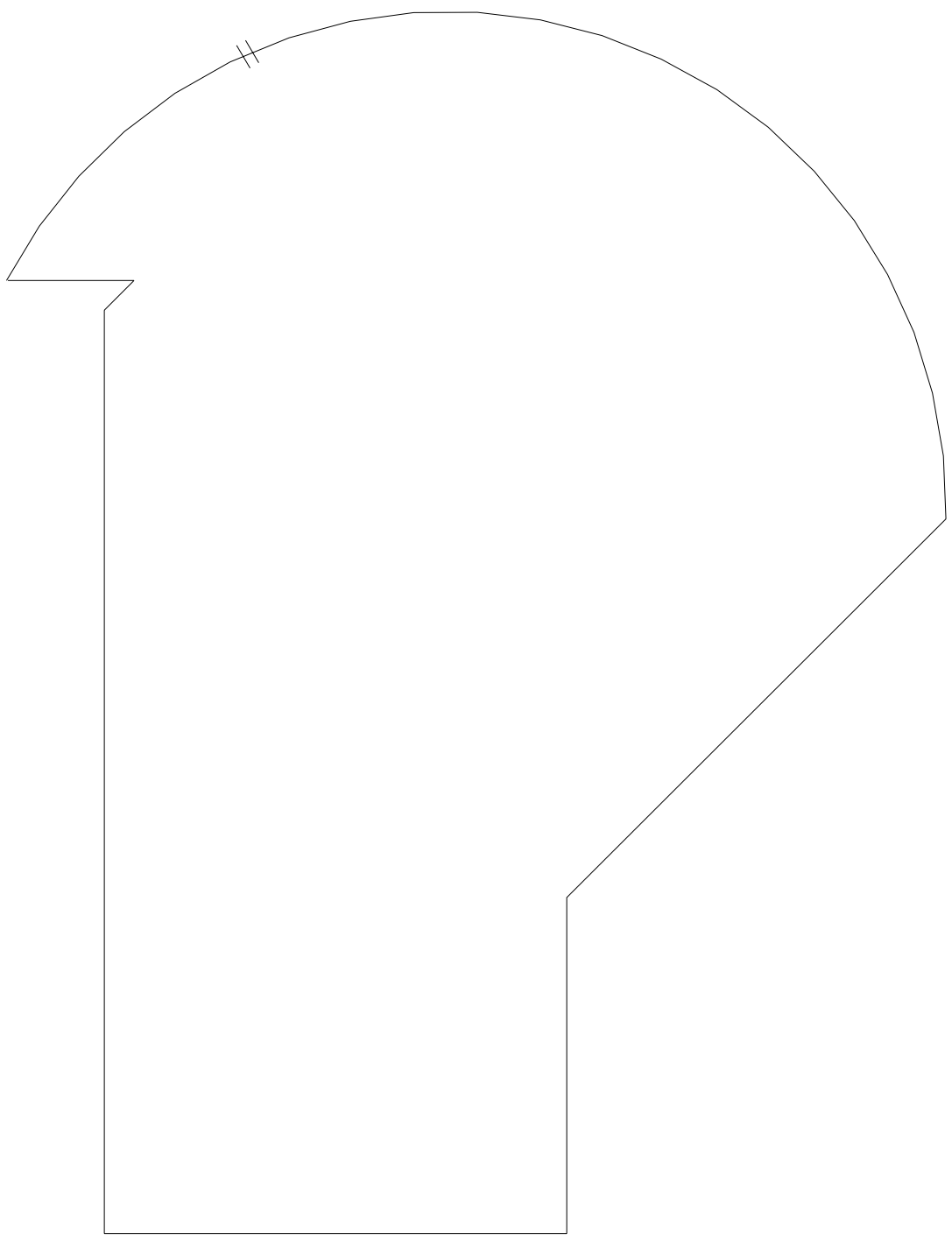

SYMBOLS KEY
|| SCUPPER

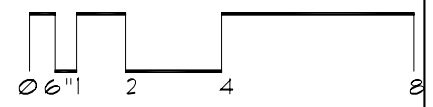
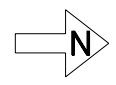

Roof ID

Building: HS178 - Nils Hasselmo Hall - (312 Church St. SE)

Total Area: 36,973 sf

<u>A</u>	<u>4,115 sf</u>	<u>E</u>	<u>22,883 sf</u>
<u>B</u>	<u>2,406 sf</u>	<u>F</u>	<u>420 sf</u>
<u>C</u>	<u>346 sf</u>	<u>G</u>	<u>211 sf</u>
<u>D</u>	<u>6,592 sf</u>		

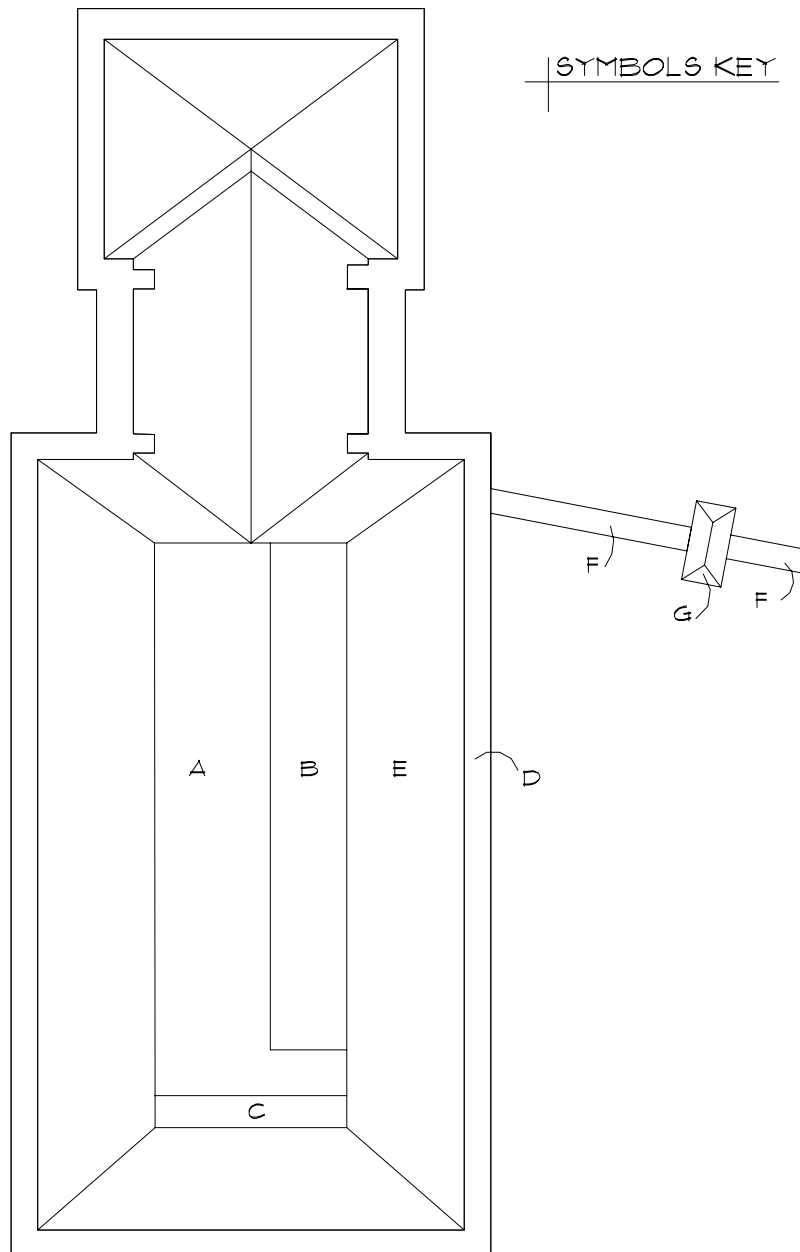

Roof Corrective Action

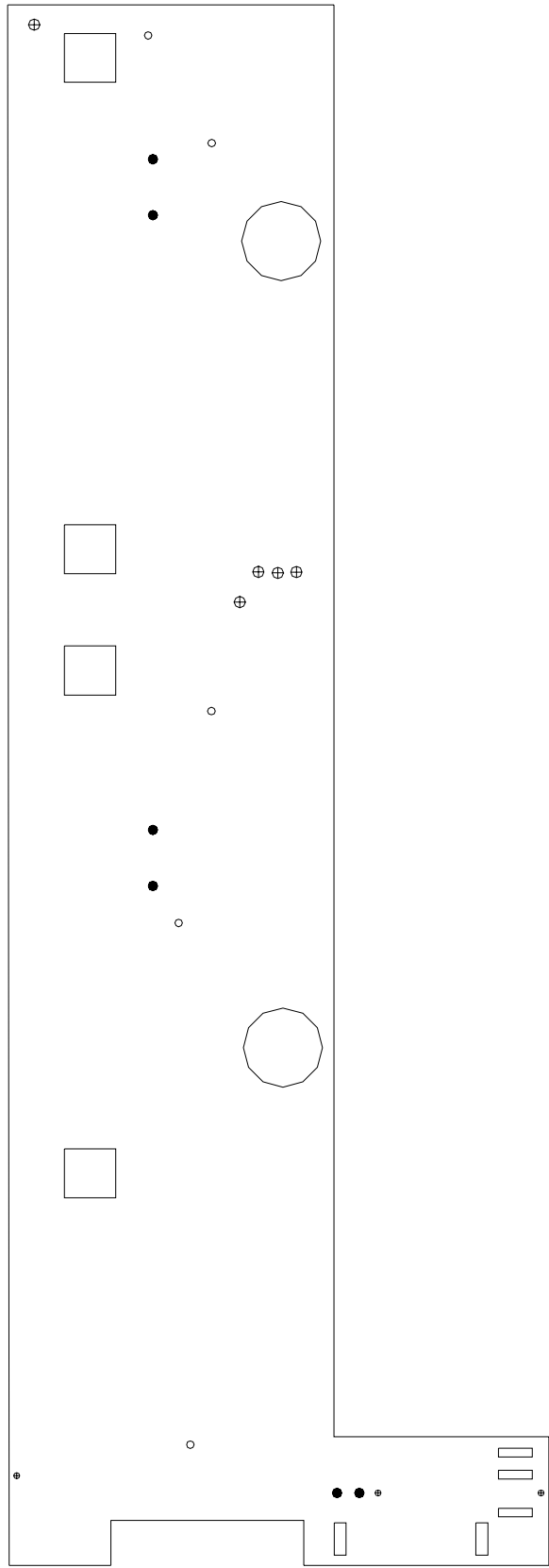

SYMBOLS KEY

- ROOF CURB
- ROOF DRAIN
- VENT STACK
- ⊕ PIPE PENETRATION
- SLEEPER CURB
- Ⓡ DEFECT-REPAIR

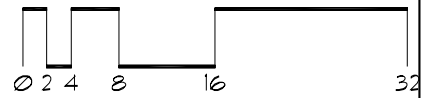
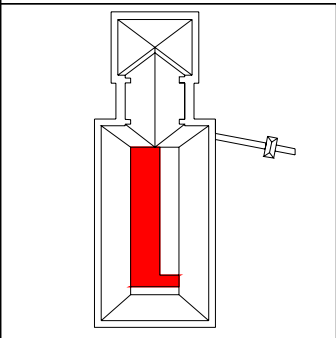

Roof Corrective Action

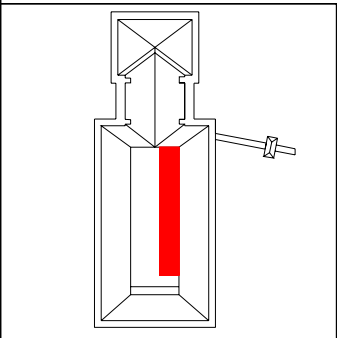
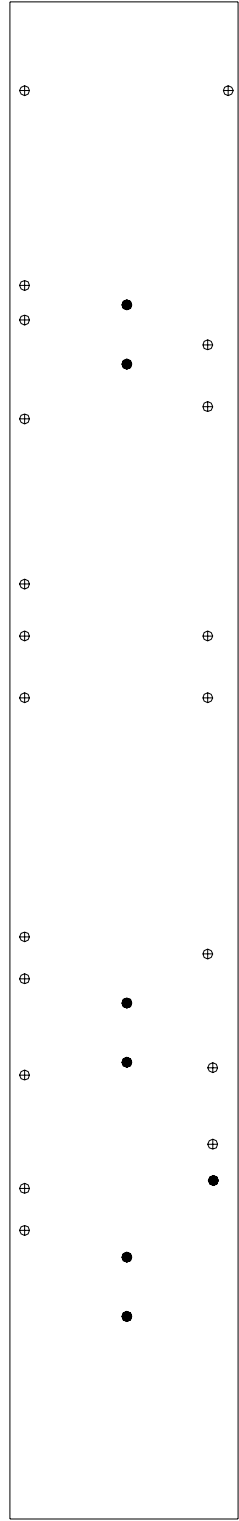

SYMBOLS KEY
● ROOF DRAIN
⊕ PIPE PENETRATION

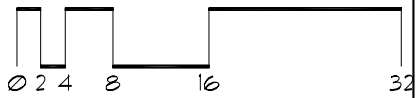
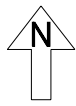

Roof Corrective Action

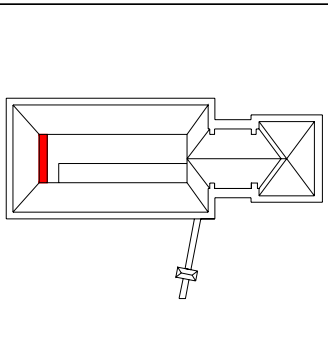
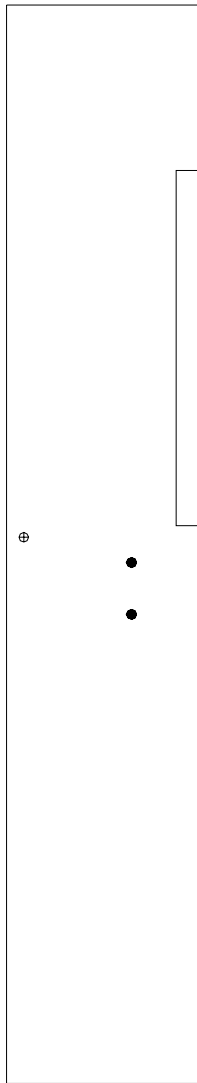

SYMBOLS KEY

- ROOF DRAIN
- ⊕ PIPE PENETRATION
- ⓪ DEFECT-NO REPAIR

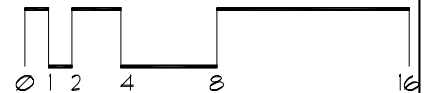
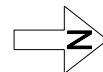

Roof Corrective Action

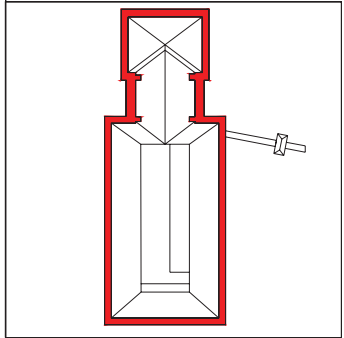
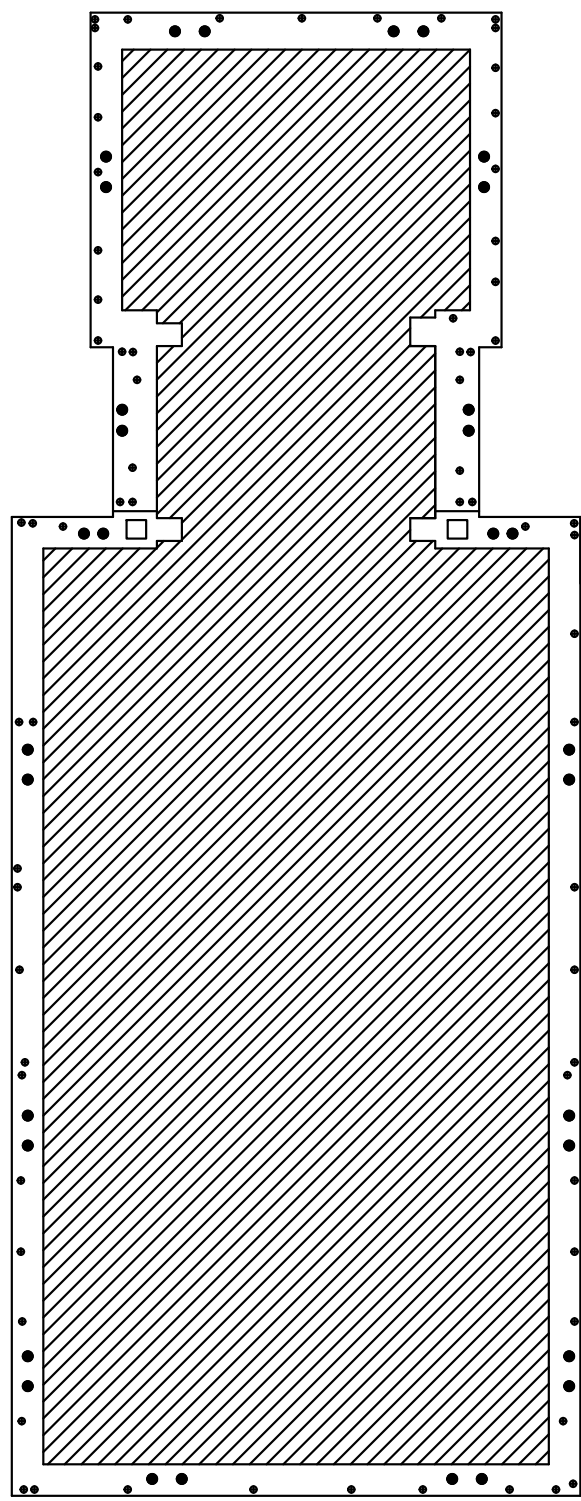

SYMBOLS KEY

- ROOF CURB
- ROOF DRAIN
- ⊕ PIPE PENETRATION
- ⓪ DEFECT-NO REPAIR

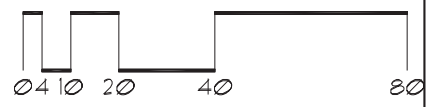

Roof Corrective Action

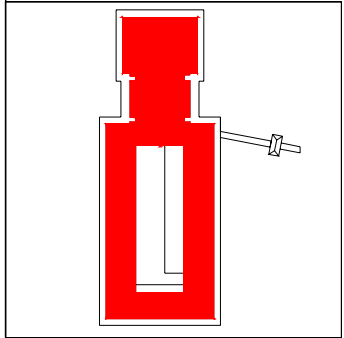
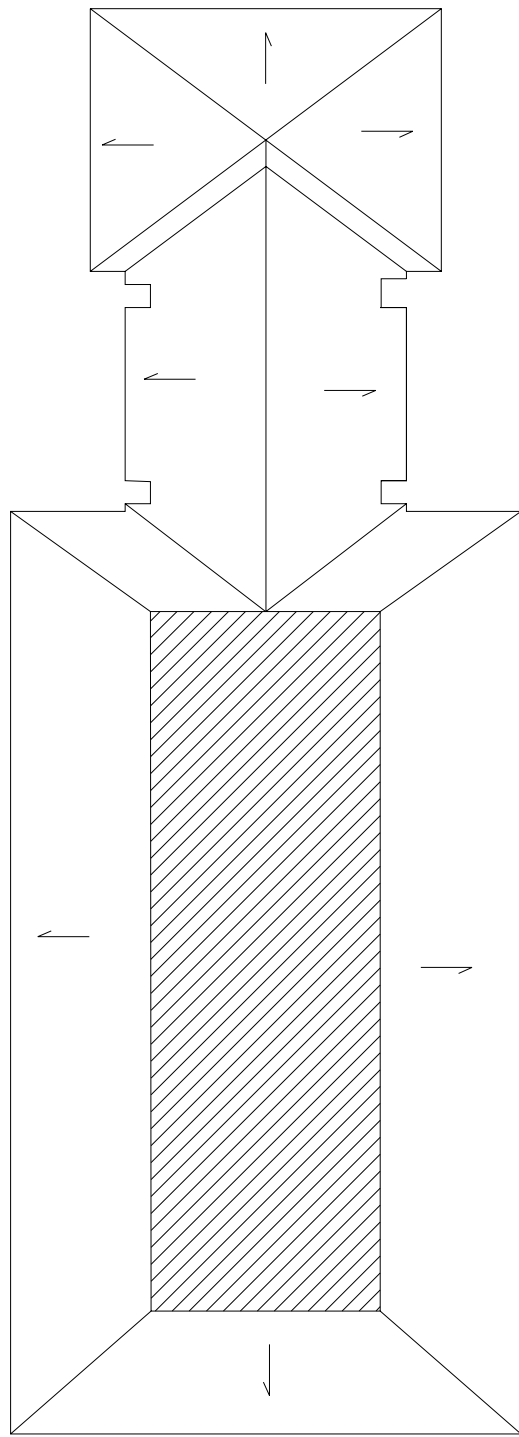

SYMBOLS KEY
|→ SLOPE DIRECTION

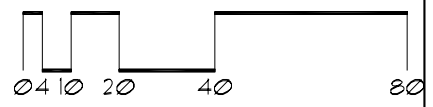

Roof Corrective Action

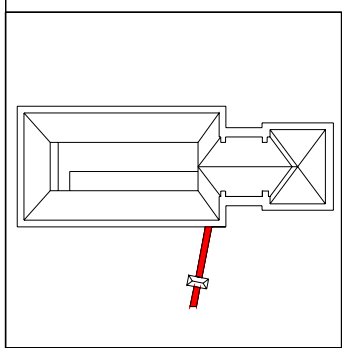
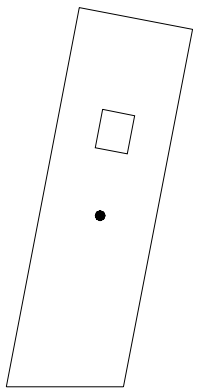
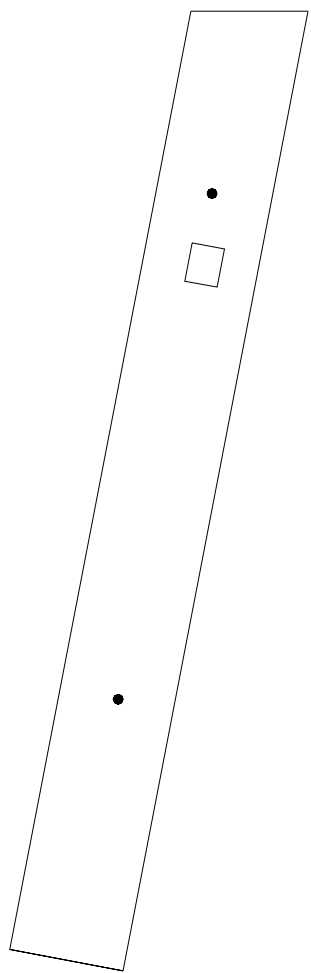

- SYMBOLS KEY**
- ROOF CURB
 - ROOF DRAIN
 - Ⓢ DEFECT-REPAIR

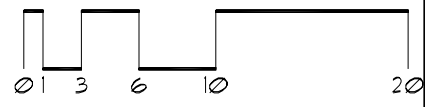
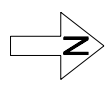

Roof Corrective Action

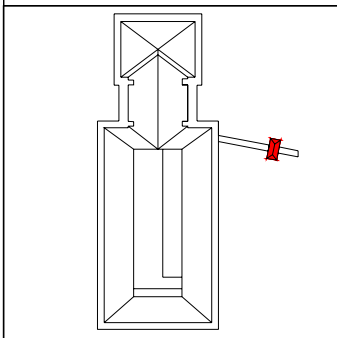
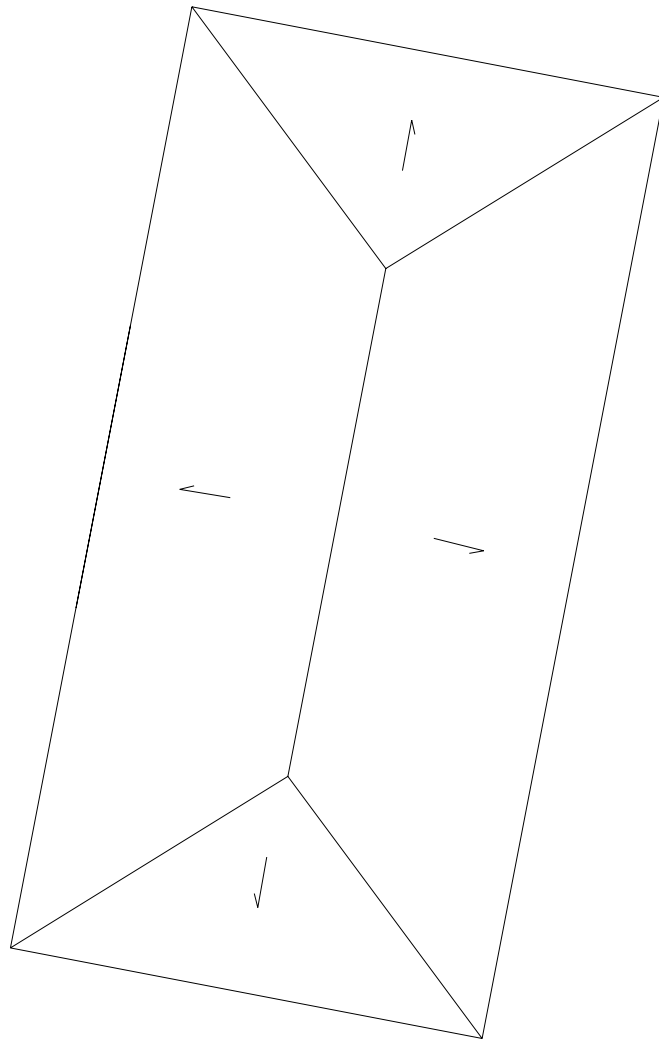

SYMBOLS KEY
→ SLOPE DIRECTION

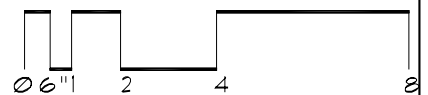

Roof ID

Building: HS186 - Molecular Cellular Biology - (420 Washington Ave.)

Total Area: 37,957 sf

A	23,438 sf	E	18 sf
B	10,746 sf	F	746 sf
C	488 sf	G	261 sf
D	2,050 sf	H	210 sf

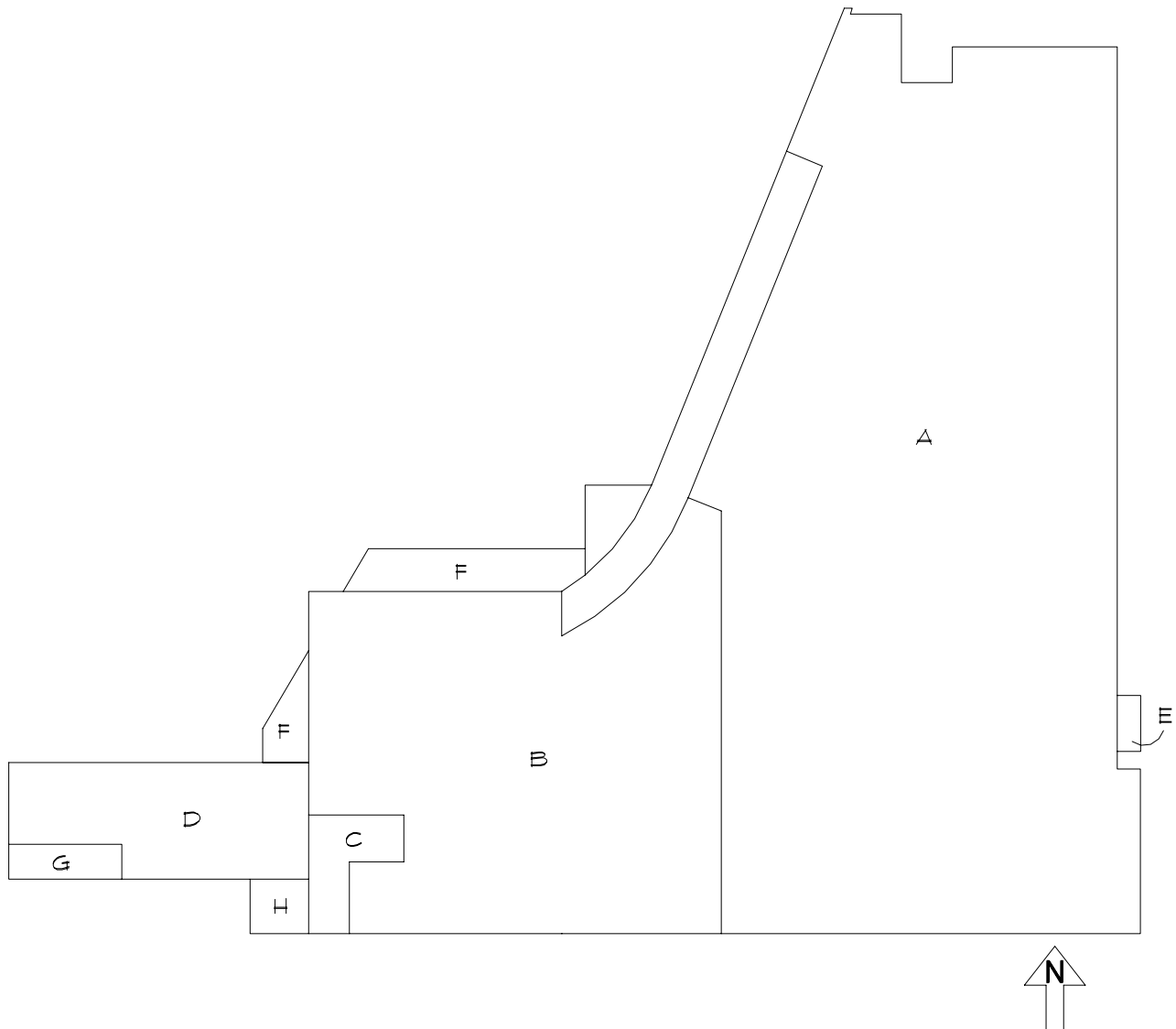

Roof Corrective Action

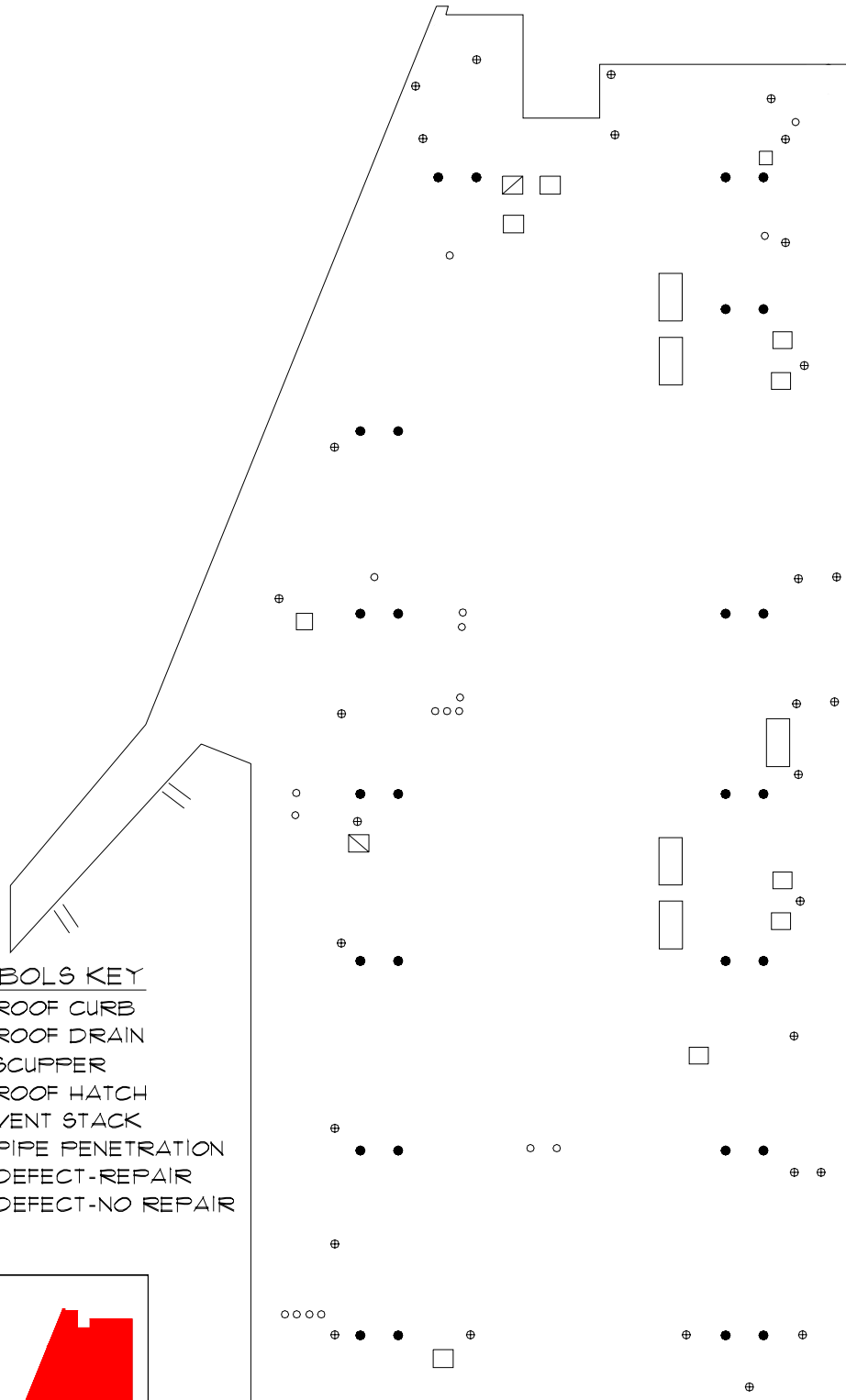

SYMBOLS KEY

- ROOF CURB
- ROOF DRAIN
- † SCUPPER
- ▣ ROOF HATCH
- VENT STACK
- ⊕ PIPE PENETRATION
- ⊕ (in red circle) DEFECT-REPAIR
- ⊕ (in white circle) DEFECT-NO REPAIR

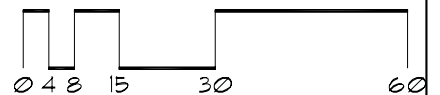
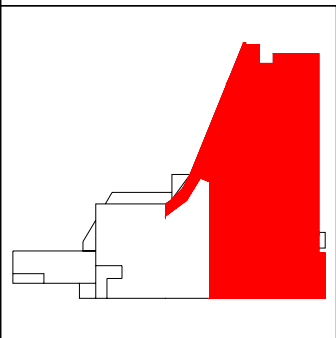

Roof Corrective Action

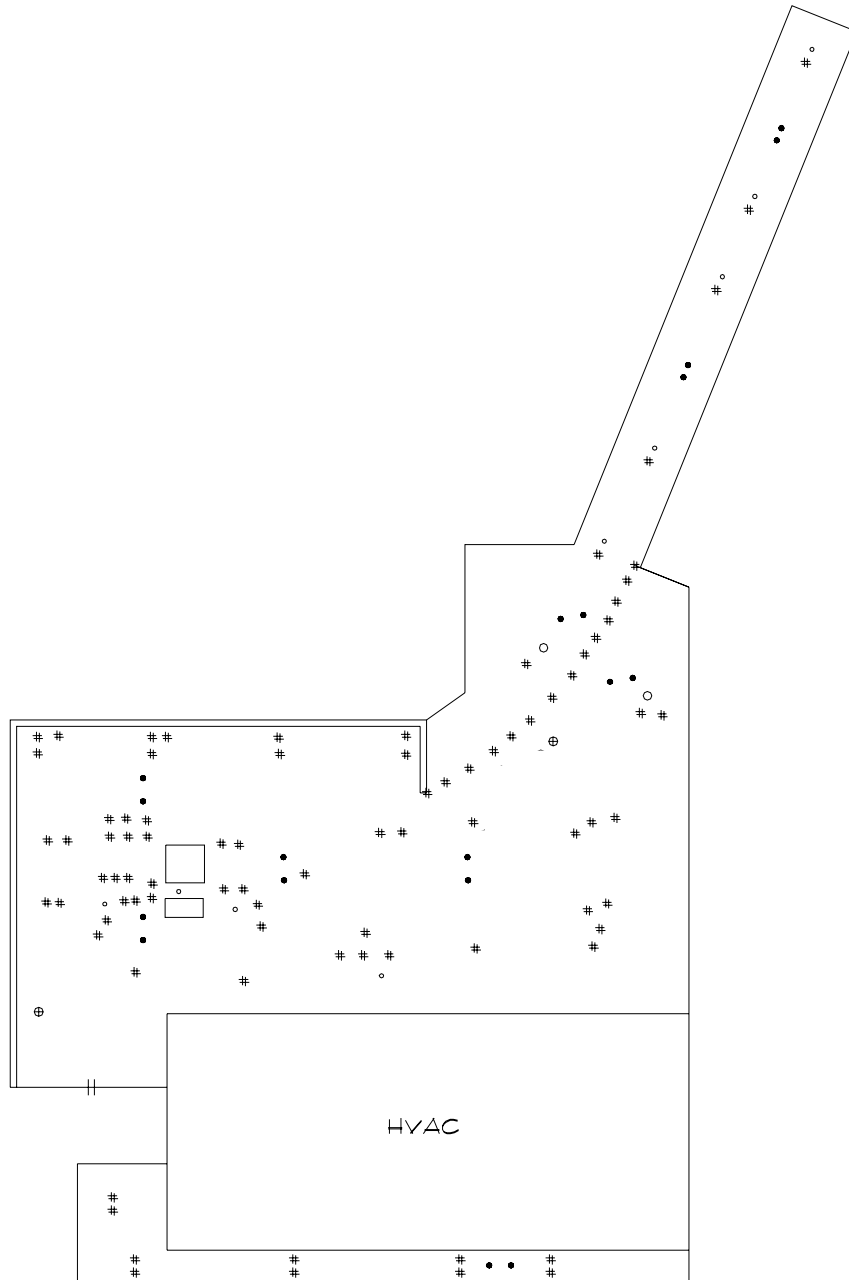

SYMBOLS KEY

- ROOF CURB
- ROOF DRAIN
- VENT STACK
- || SCUPPER
- # PITCH PAN
- ⊕ PIPE PENETRATION
- ⊕ (red outline) DEFECT-REPAIR
- ⊕ (white outline) DEFECT-NO REPAIR

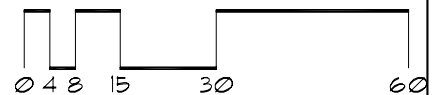
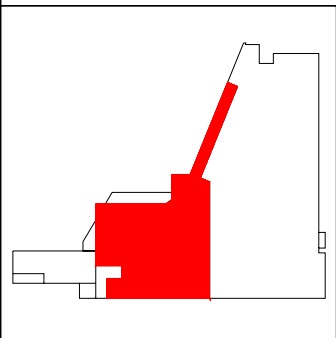

Roof Corrective Action

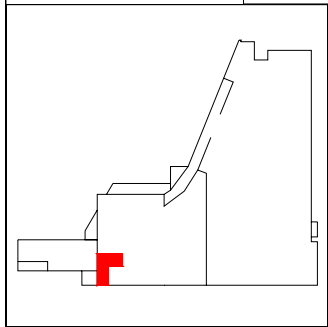
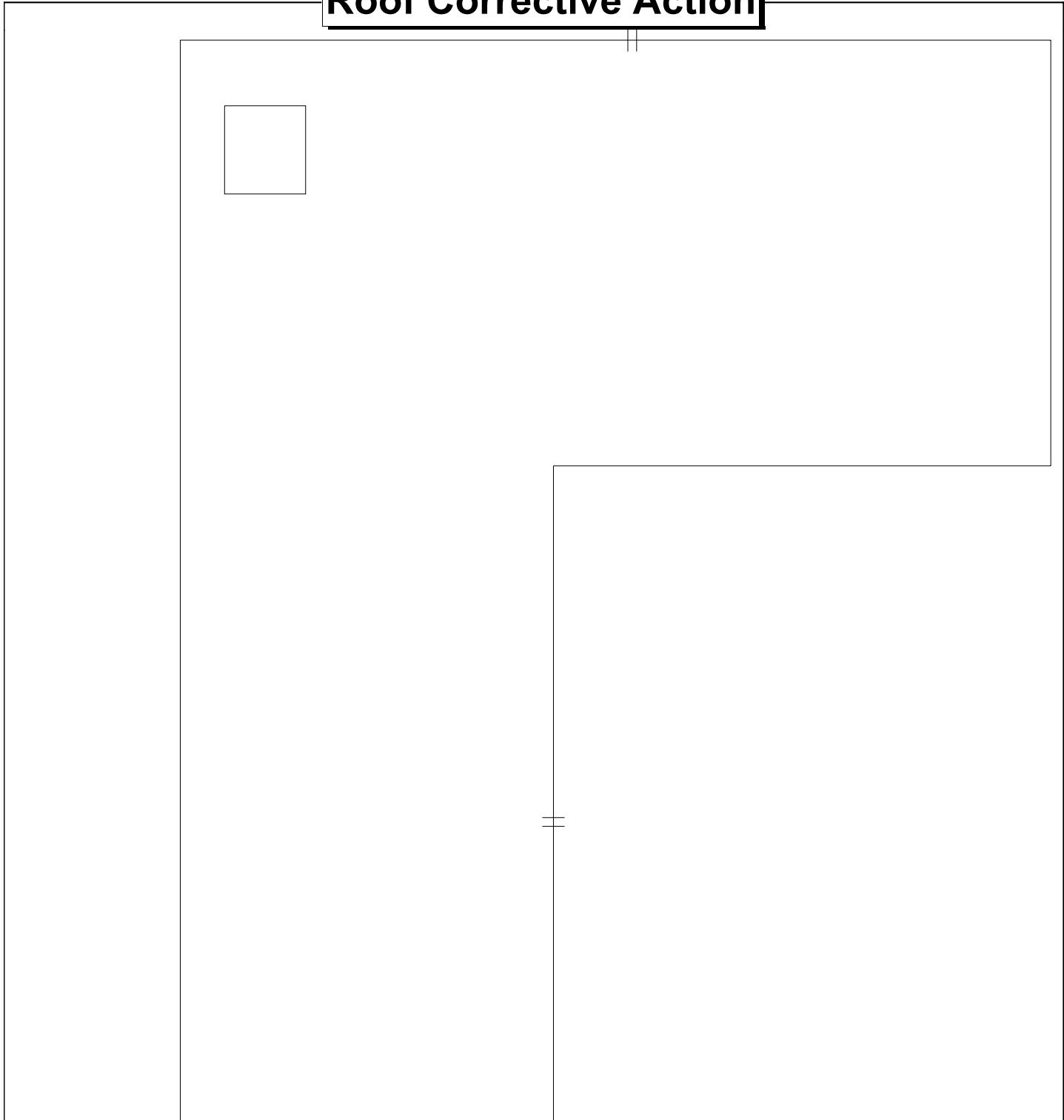

SYMBOLS KEY
□ ROOF CURB
⊕ SCUPPER

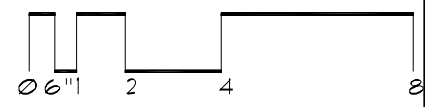

Roof Corrective Action

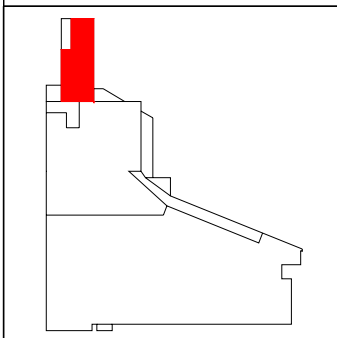
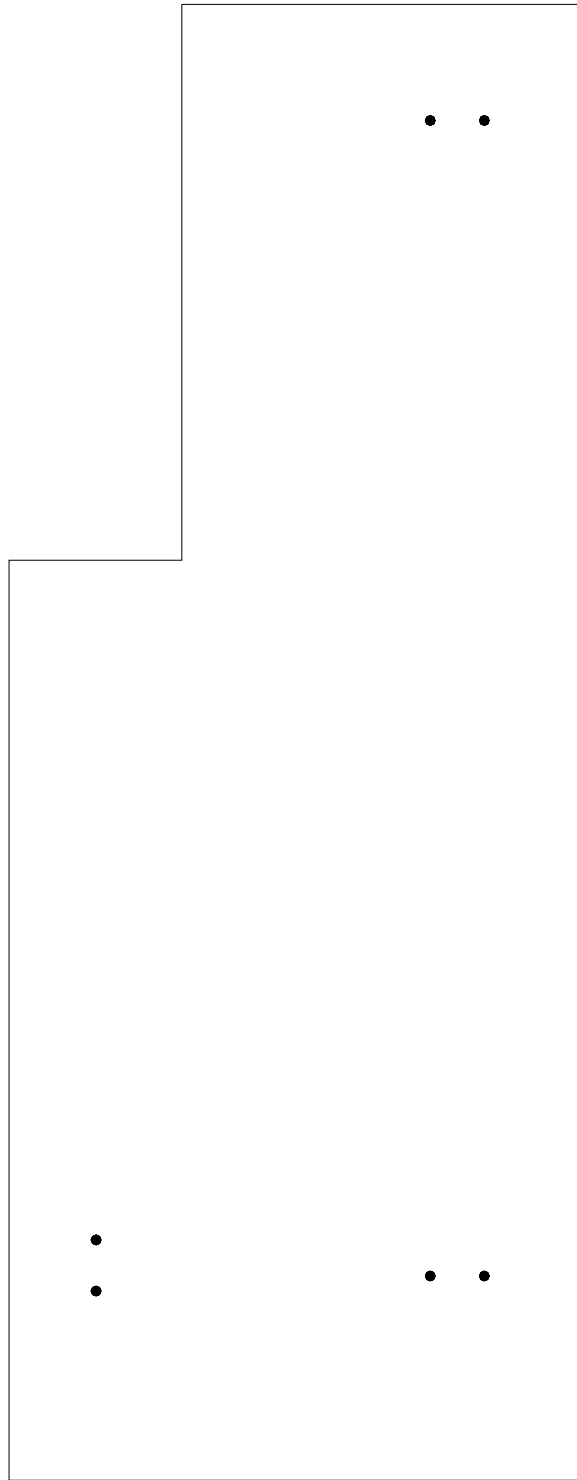

SYMBOLS KEY
• ROOF DRAIN

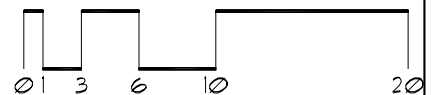

Roof Corrective Action

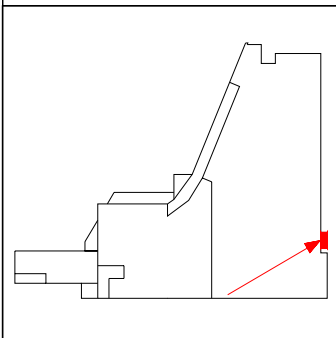
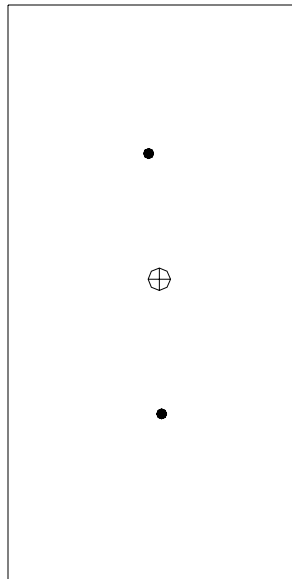

SYMBOLS KEY
● ROOF DRAIN
⊕ PIPE PENETRATION

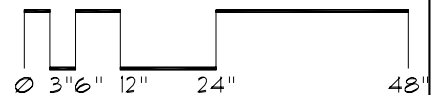

Roof Corrective Action

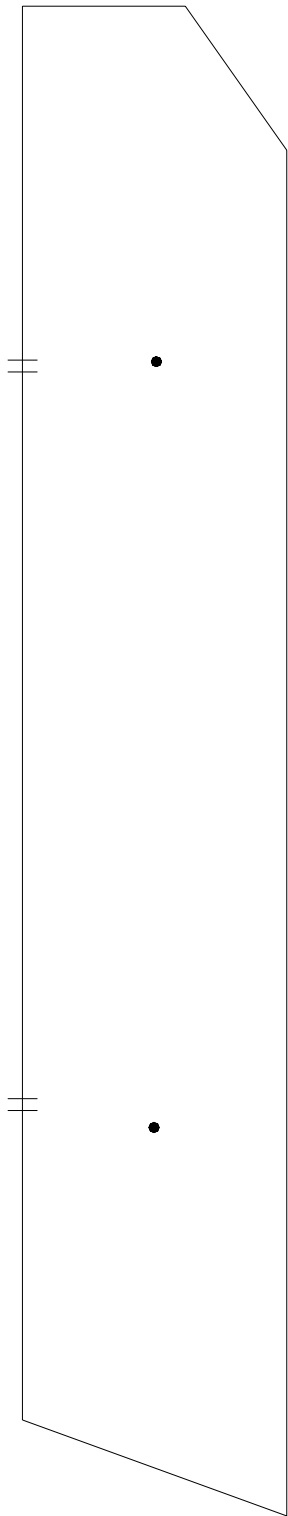

- SYMBOLS KEY
- || SCUPPER
 - ROOF DRAIN
 - Ⓢ DEFECT-REPAIR

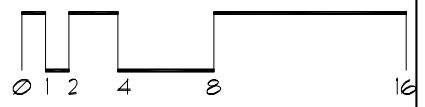
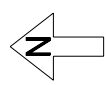
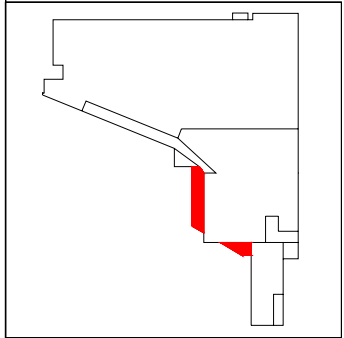
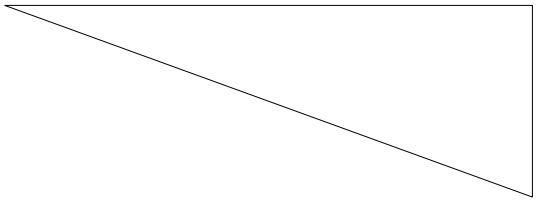

Roof Corrective Action

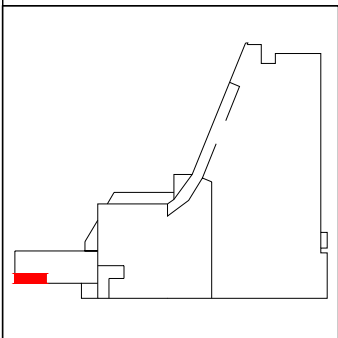

SYMBOLS KEY
|| SCUPPER

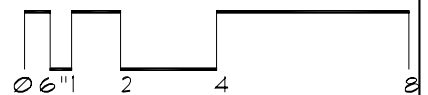

Roof Corrective Action

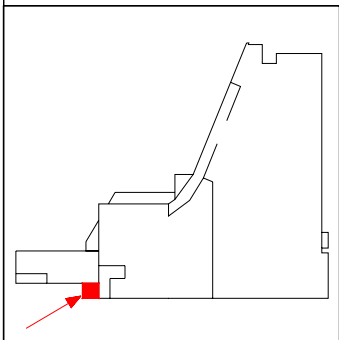
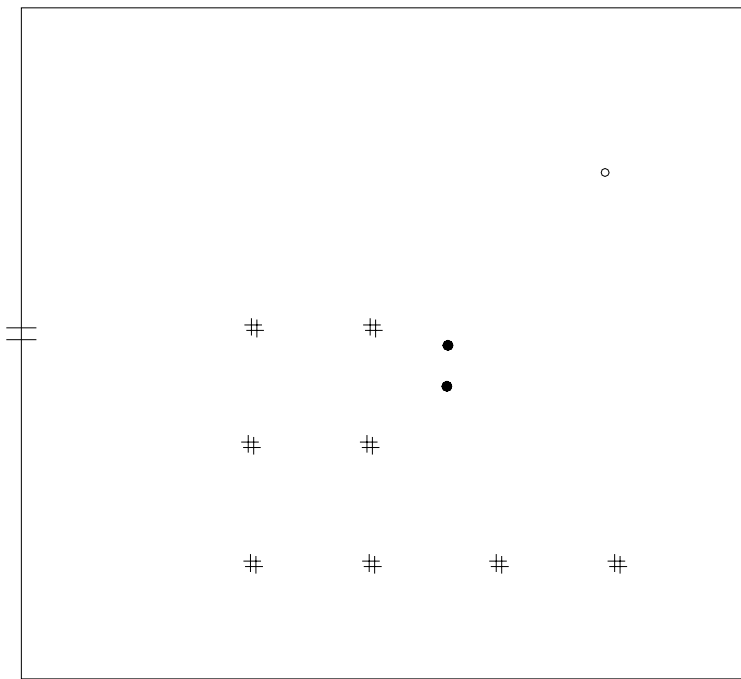

SYMBOLS KEY

#	PITCH PAN
	SCUPPER
•	DEFECT-REPAIR

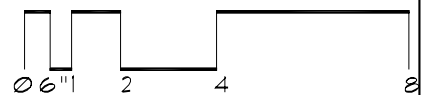

Roof ID

Building: HS193 - 717 Delaware - (717 Delaware St. SE)

Total Area: 29,031 sf

A 24,778 sf

B 1,826 sf

C 1,826 sf

D 601 sf

SYMBOLS KEY

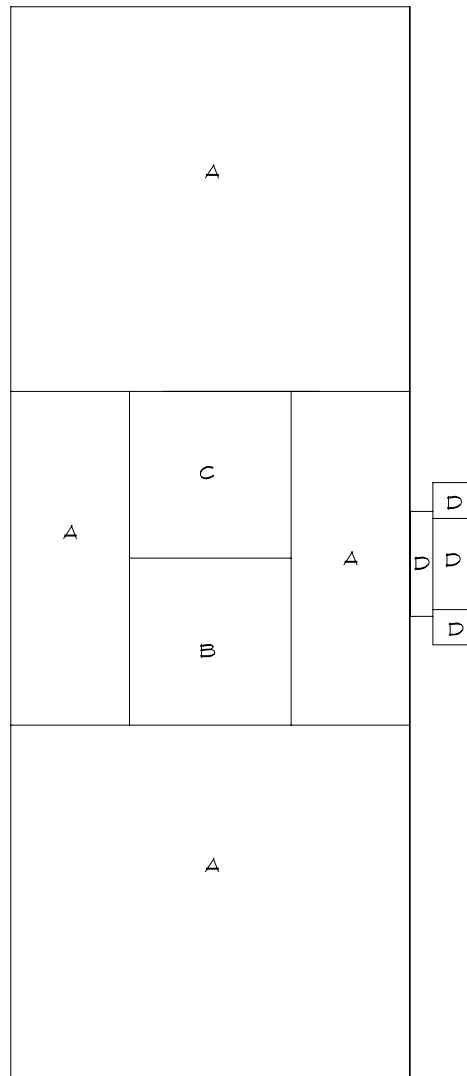

Roof Corrective Action

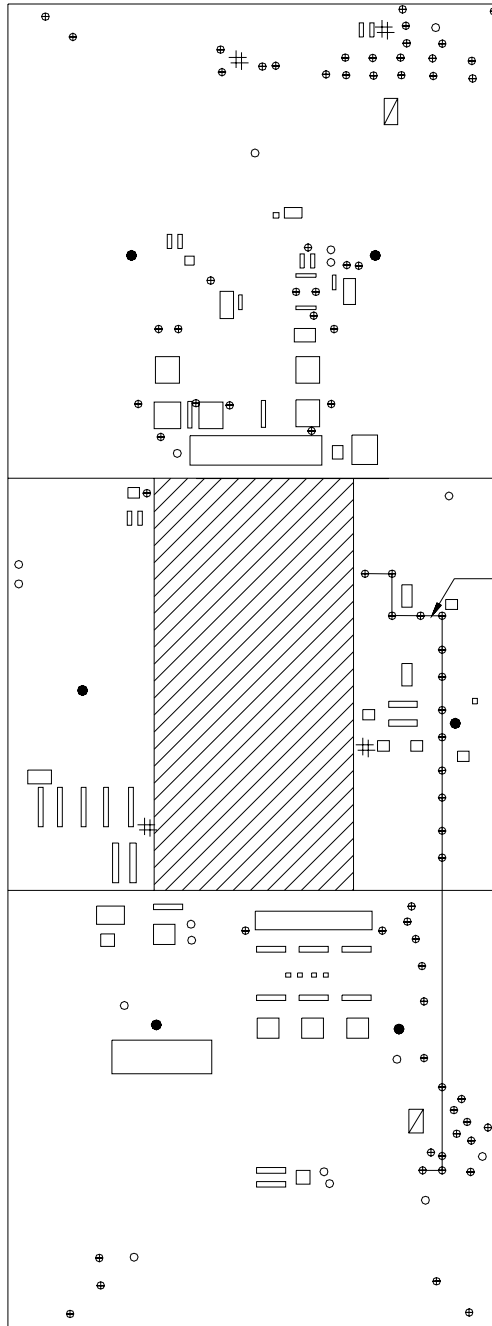

RAILING

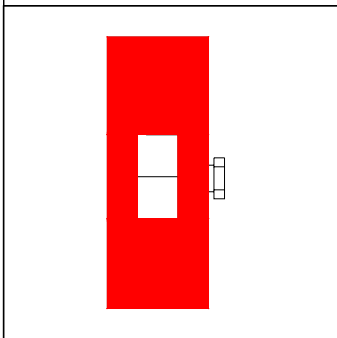

SYMBOLS KEY

- ROOF CURB
- ⊕ PIPE PENETRATION
- VENT STACK
- # PITCH PAN
- ≡ SLEEPER CURB
- ▣ ROOF HATCH
- Ⓢ DEFECT-REPAIR

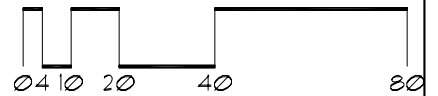

Roof Corrective Action

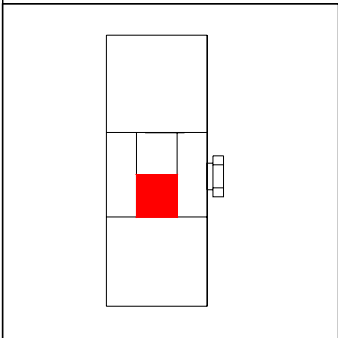

SYMBOLS KEY

- ROOF DRAIN
- VENT STACK
- # PITCH PAN
- ⊕ DEFECT-REPAIR

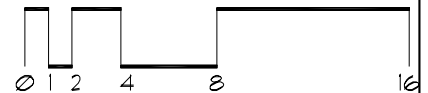
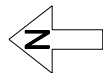

Roof Corrective Action

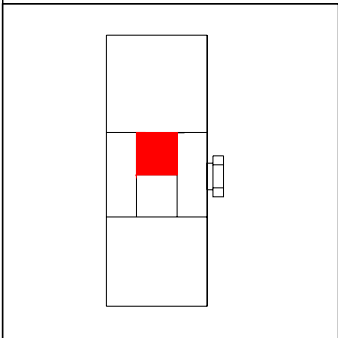
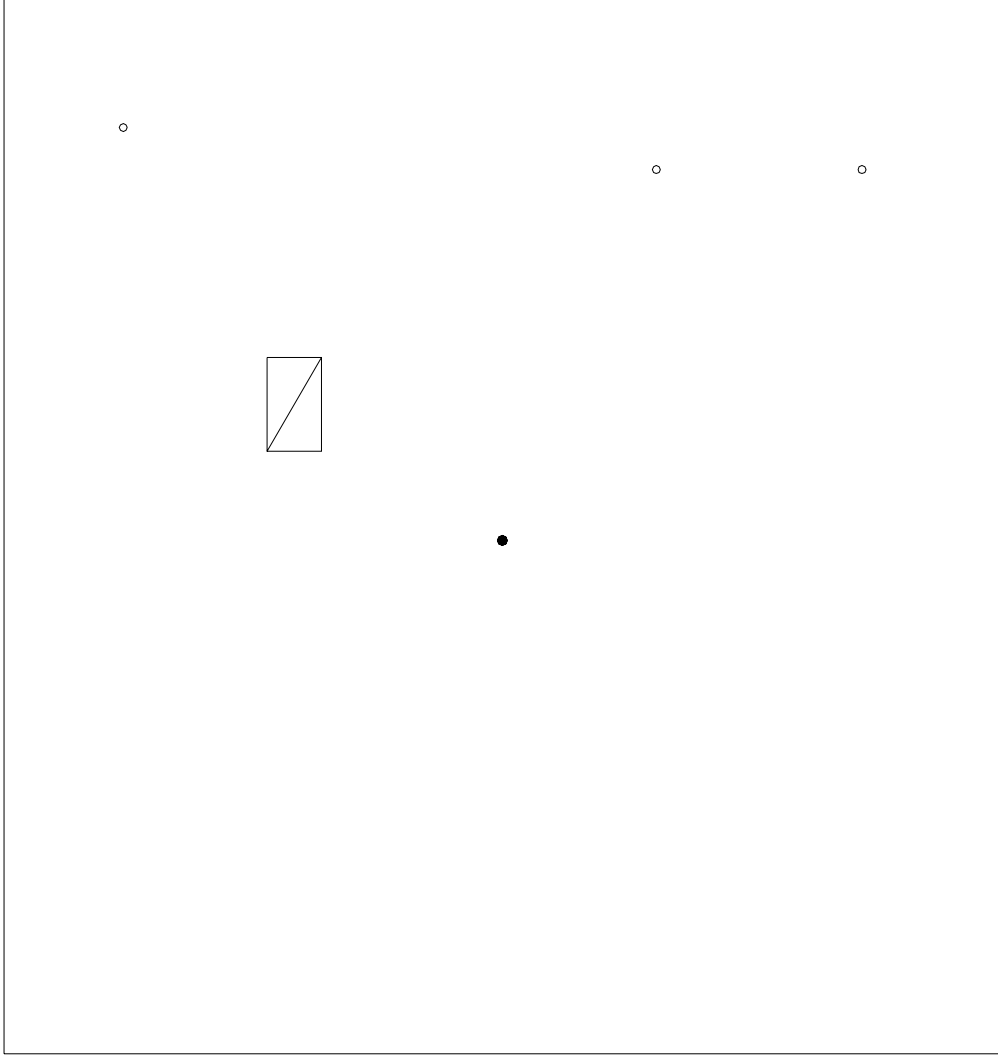

SYMBOLS KEY

- ROOF DRAIN
- VENT STACK
- # PITCH PAN
- ① DEFECT-NO REPAIR
- ☒ ROOF HATCH

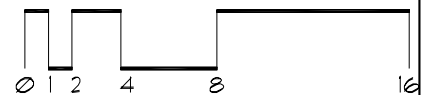
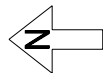

Roof Corrective Action

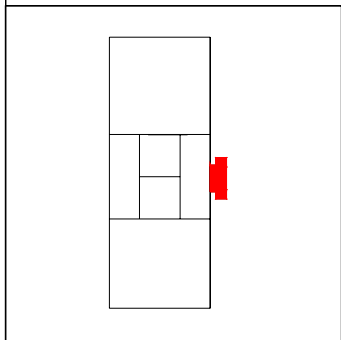
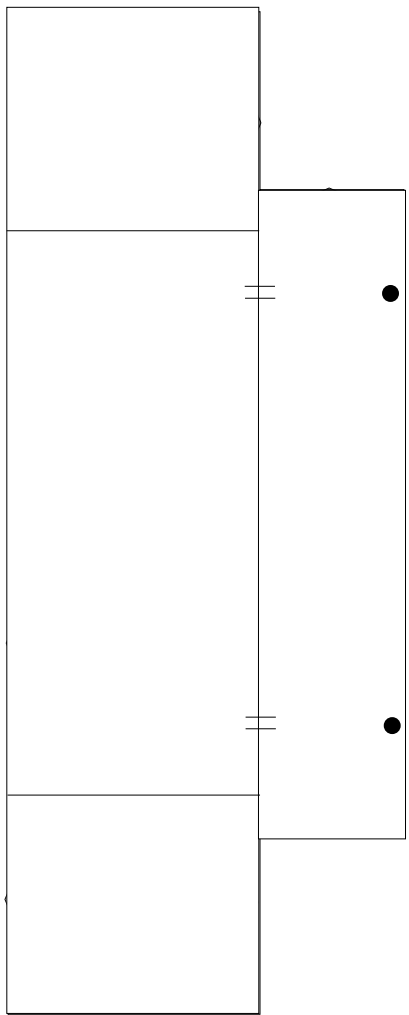

SYMBOLS KEY

- † SCUPPER
- ROOF DRAIN
- ① DEFECT-NO REPAIR

