

Roof Drawing Index  
Housing

Last Updated: 3/27/2012

Bldg No	Building Name	Plan view Drawing	Roof Penetrations Drawing	Date Assessed
028	SANFORD HALL	Y	Y	11/1/2010
030	ROY WILKINS HALL	Y	Y	11/1/2010
052	PIONEER HALL	Y	Y	11/1/2010
063	COMSTOCK HALL	Y	Y	11/1/2010
068	CENTENNIAL HALL	Y	Y	11/1/2010
105	TERRITORIAL HALL	Y	Y	11/1/2010
110	FRONTIER HALL	Y	Y	11/1/2010
120	PILLSBURY COURT	N	N	
150	COMO COMMUNITY CENTER	Y	Y	11/1/2010
151	COMO MARRIED STUDENT HOUSING	Y	Y	11/1/2010
189	YUDOF HALL, MARK G.	Y	Y	11/1/2010
213	WEST BANK STUDENT HOUSING	N	N	
383	BAILEY RESIDENCE HALL	Y	Y	11/1/2010
384	COMMONWEALTH TERRACE CO-OP	Y	N	
<b>14</b>		<b>12</b>	<b>11</b>	

\*Roof Drawings organized into (4) Packages; East Bank, St Paul / West, Health Sciences & Housing

# Roof ID

Building: 383 - Bailey Hall - (1458 Cleveland Ave N St. Paul)

Total Area: 28,154 sf

<u>A</u>	<u>8,804</u> sf	<u>E</u>	<u>135</u> sf	<u>I</u>	<u>490</u> sf
<u>B</u>	<u>80</u> sf	<u>F</u>	<u>1,764</u> sf	<u>J</u>	<u>160</u> sf
<u>C</u>	<u>5,920</u> sf	<u>G</u>	<u>2,016</u> sf	<u>K</u>	<u>432</u> sf
<u>D</u>	<u>521</u> sf	<u>H</u>	<u>5,752</u> sf	<u>L</u>	<u>2,080</u> sf

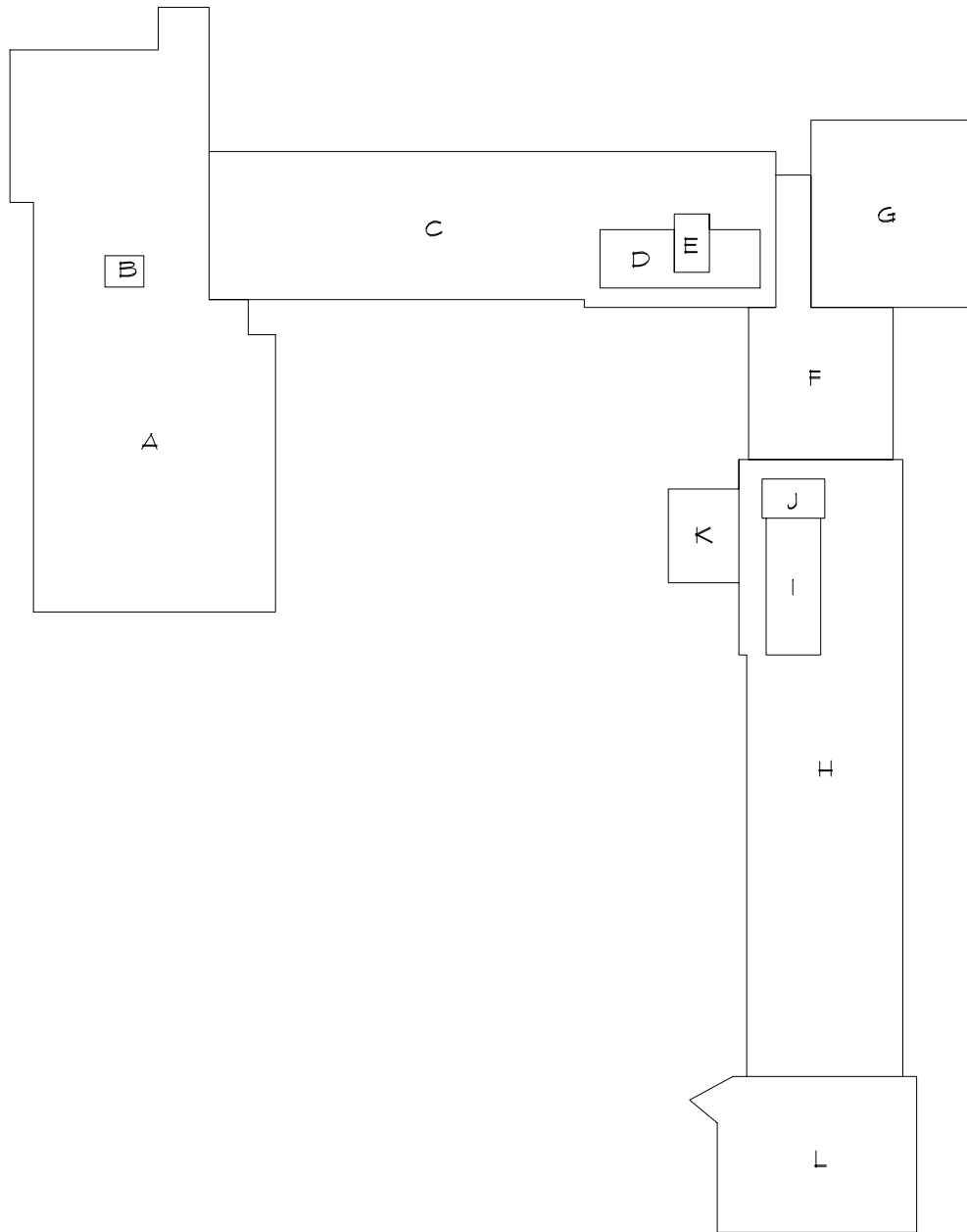

# Roof Corrective Action

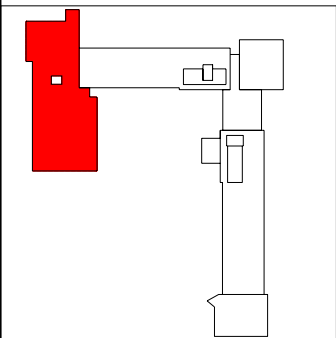
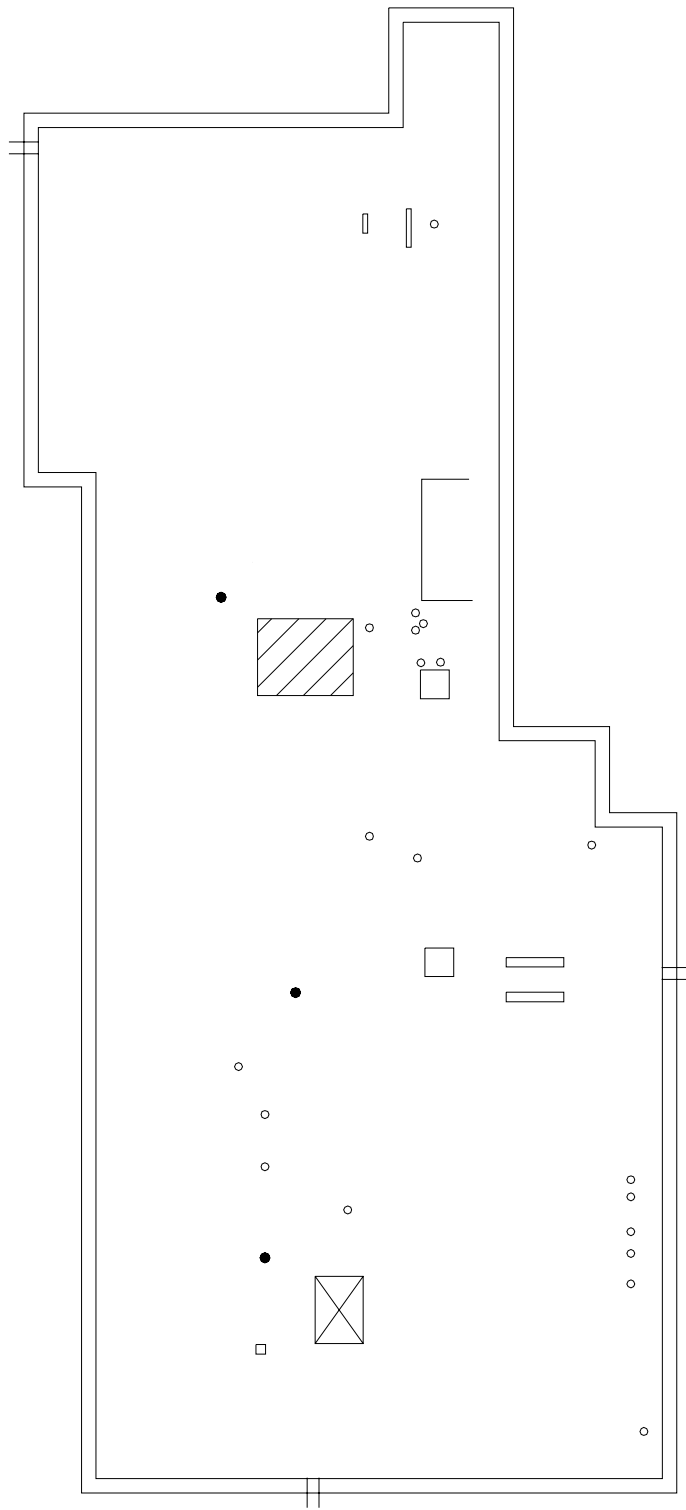

## SYMBOLS KEY

- ROOF CURB
- ROOF DRAIN
- VENT STACK
- † SCUPPER
- ⊠ SKYLIGHT
- ① DEFECT-NO REPAIR

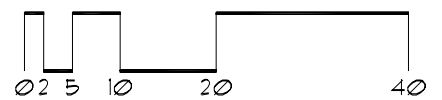
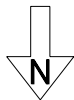

# Roof Corrective Action

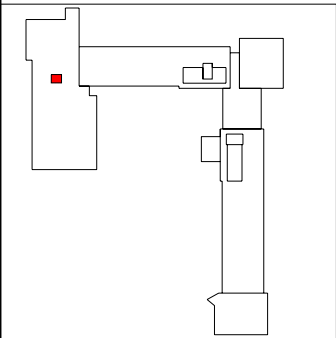
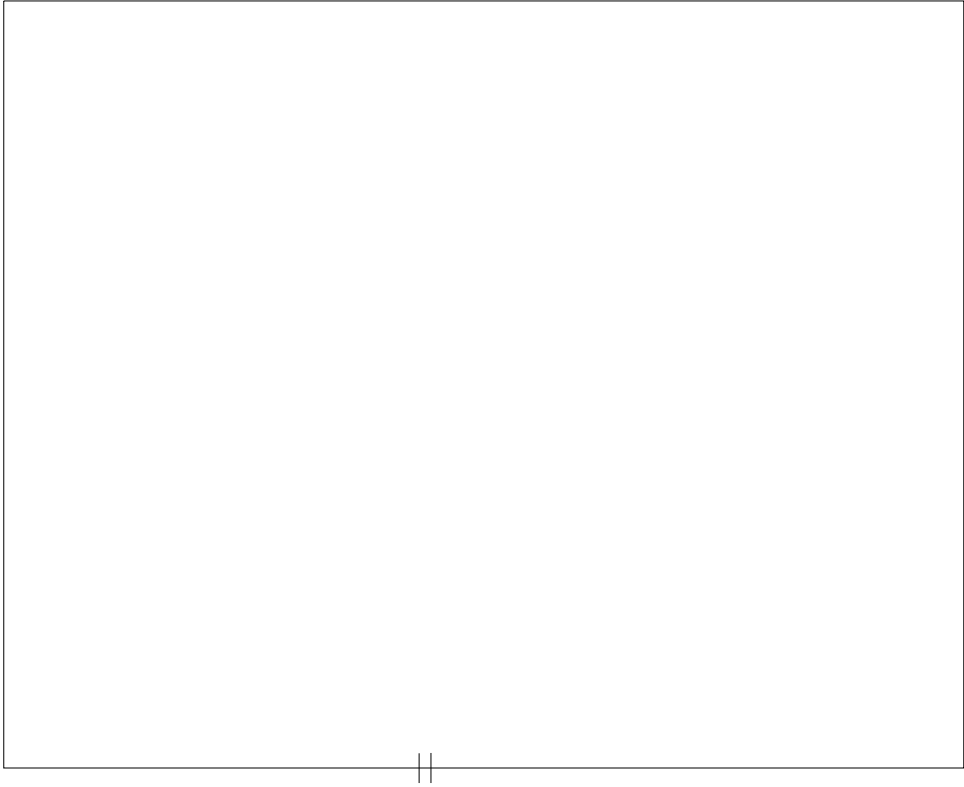

SYMBOLS KEY  
|| SCUPPER  
① DEFECT-NO REPAIR

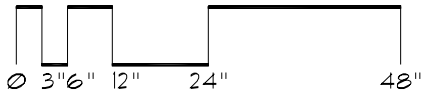

# Roof Corrective Action

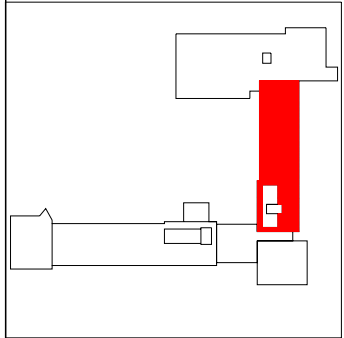
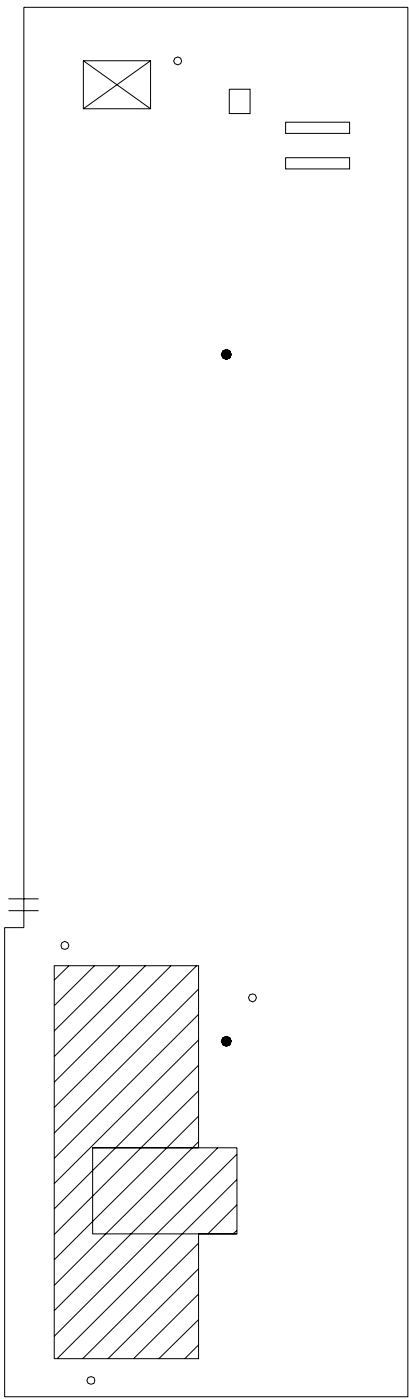

## SYMBOLS KEY

- ROOF CURB
- ROOF DRAIN
- VENT STACK
- ≡ SCUPPER
- ⓪ DEFECT-NO REPAIR

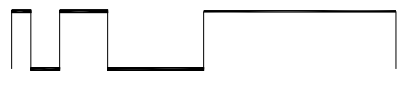
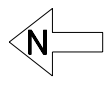

# Roof Corrective Action

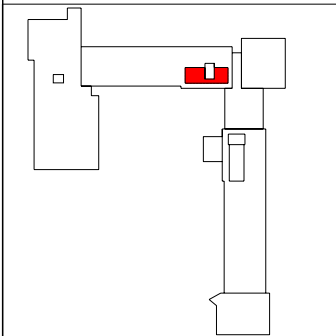
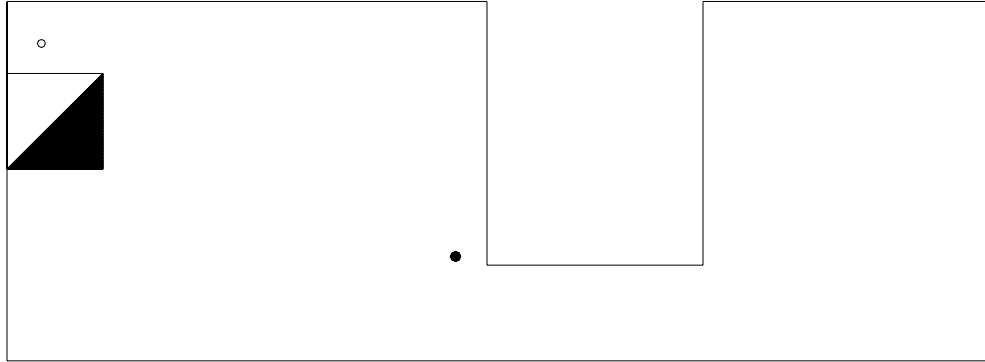

## SYMBOLS KEY

- ROOF DRAIN
- VENT STACK
- ▴ CHIMNEY
- ① DEFECT-NO REPAIR

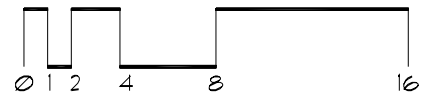
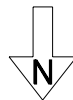

# Roof Corrective Action

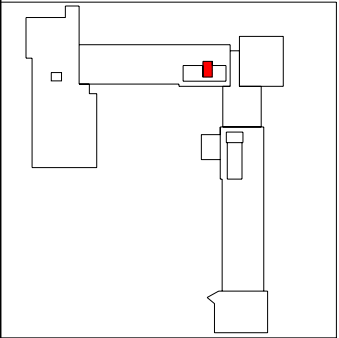
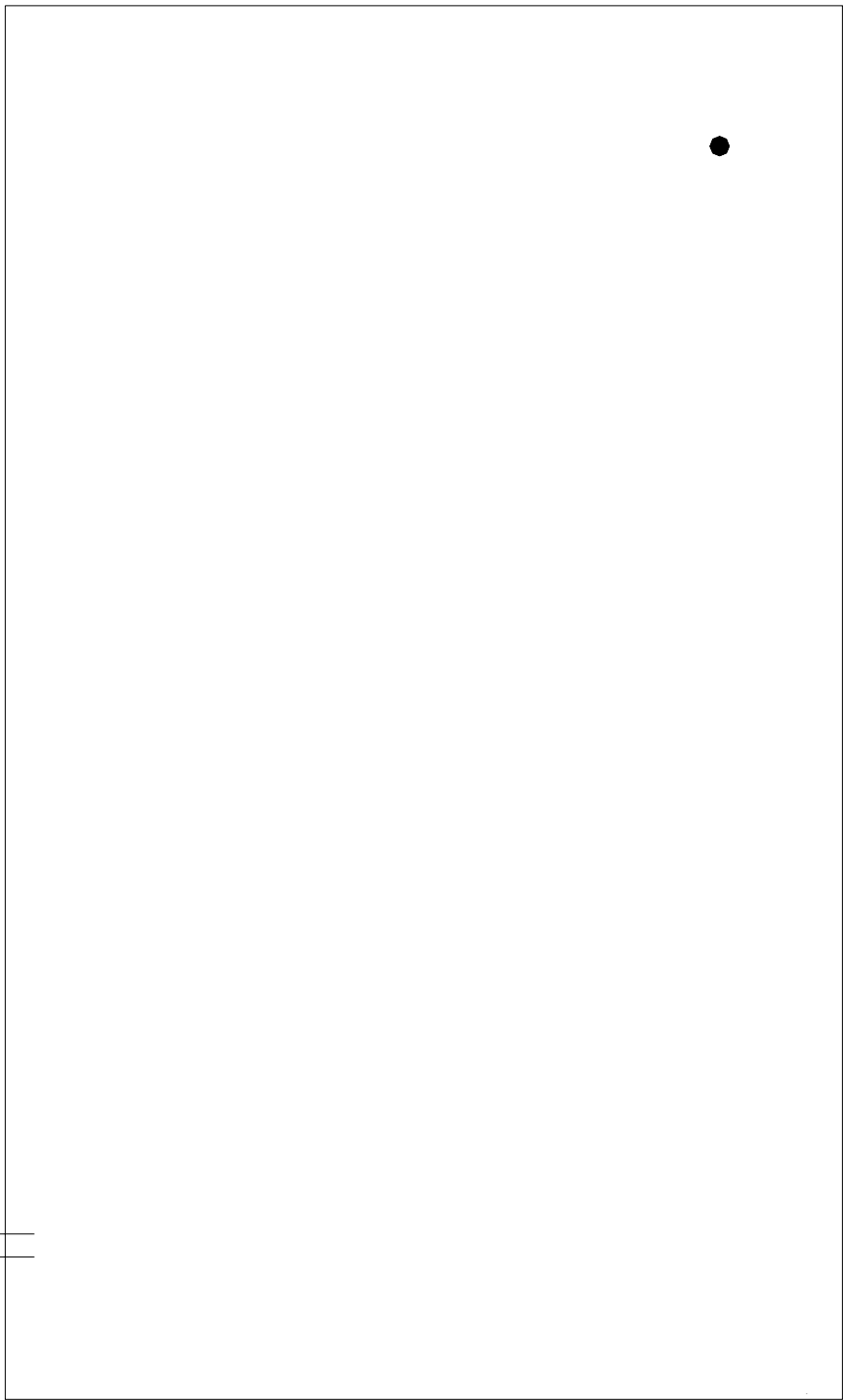

- SYMBOLS KEY**
- ROOF DRAIN
  - ≡ SCUPPER
  - ⓪ DEFECT-NO REPAIR

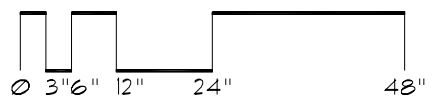

# Roof Corrective Action

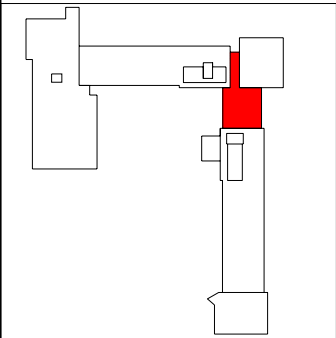
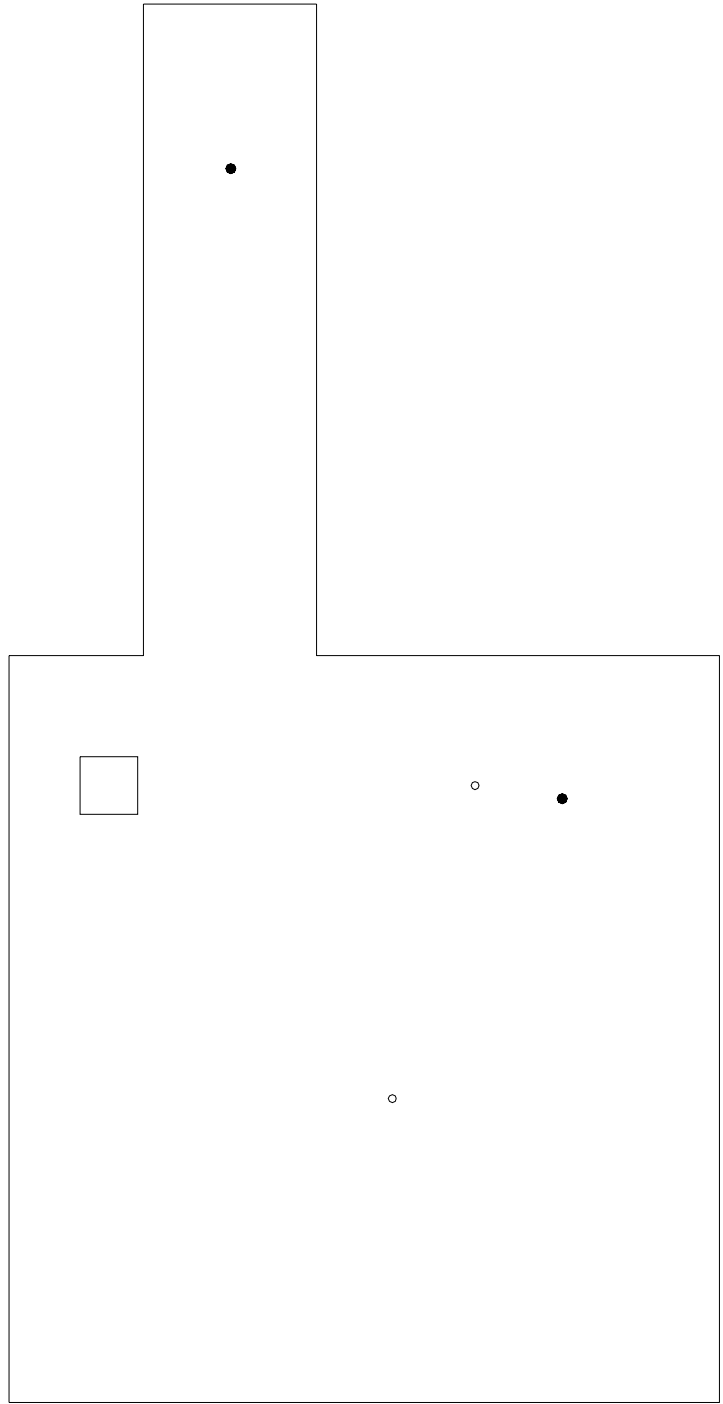

- SYMBOLS KEY
- ROOF CURB
  - ROOF DRAIN
  - VENT STACK

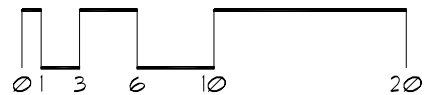



# Roof Corrective Action

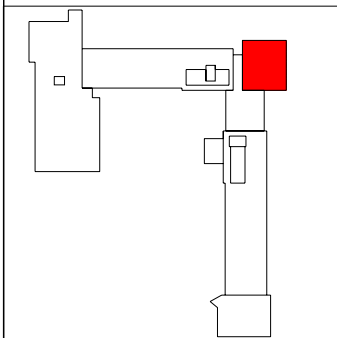
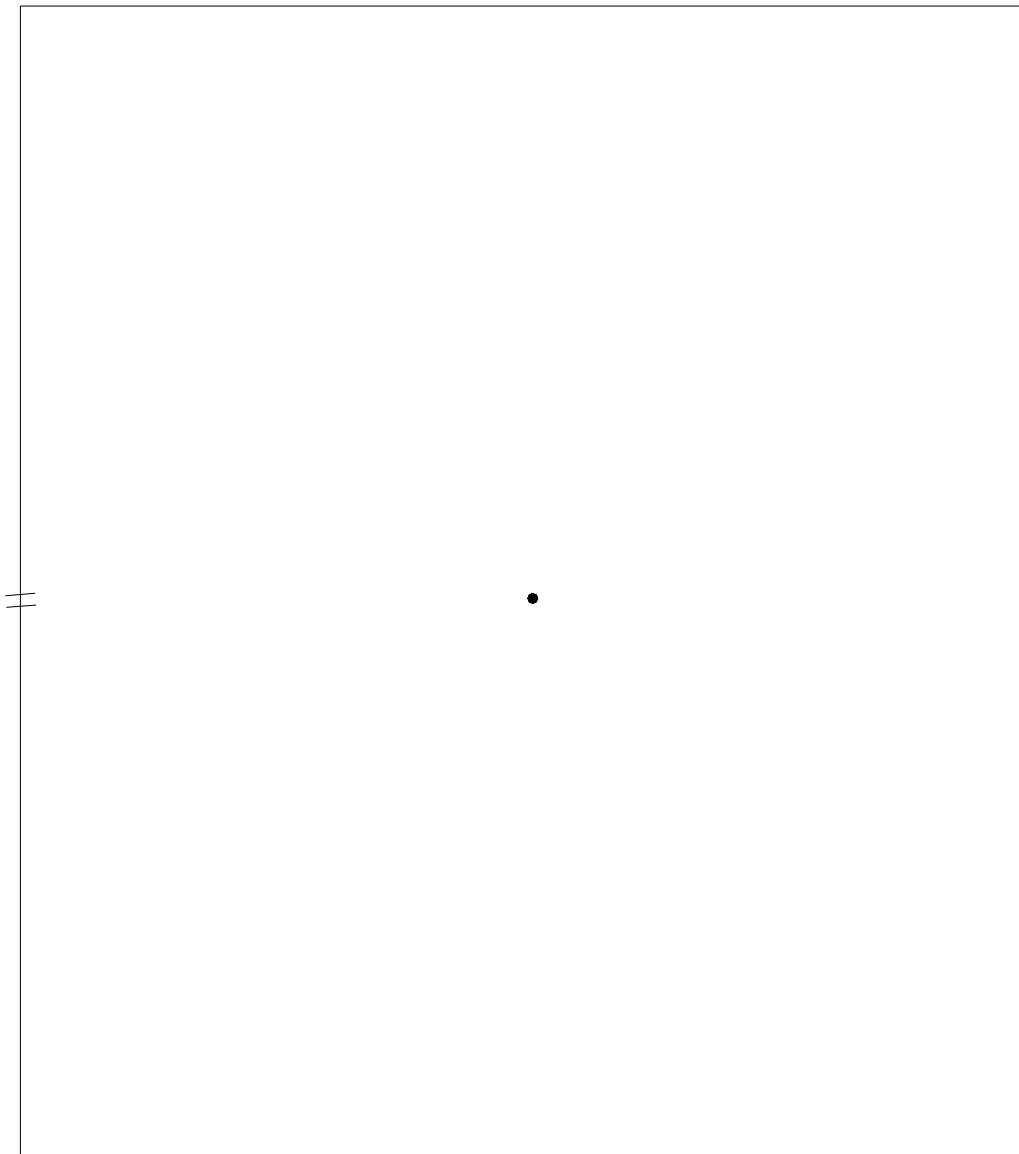

SYMBOLS KEY  
● ROOF DRAIN  
⦚ SCUPPER

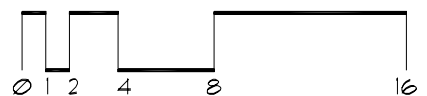

# Roof Corrective Action

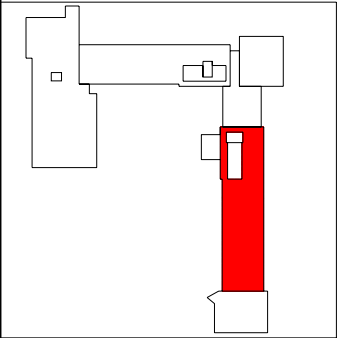
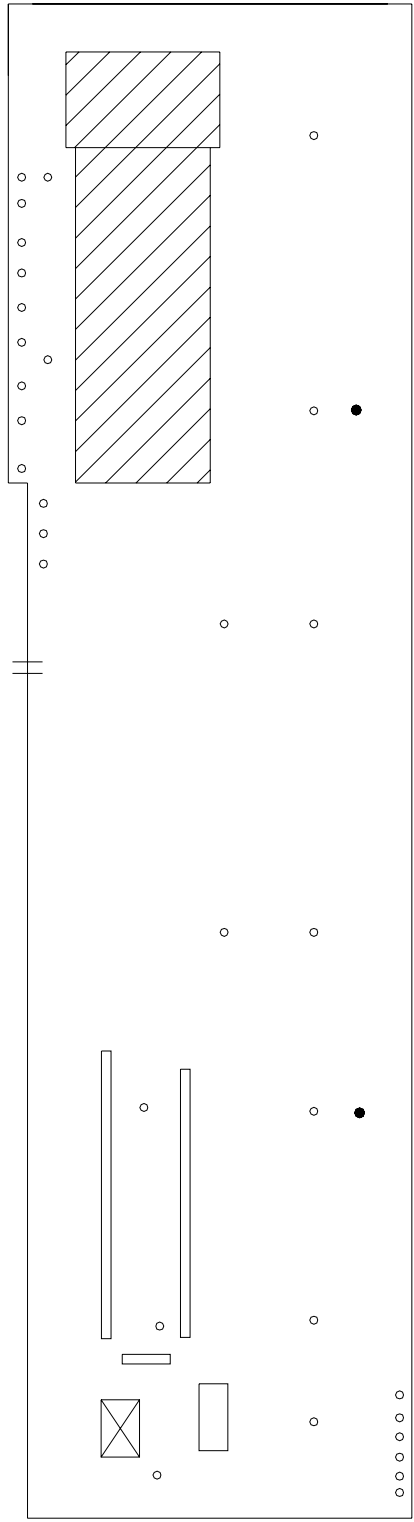

## SYMBOLS KEY

- ROOF CURB
- ROOF DRAIN
- VENT STACK
- ⊠ SKYLIGHT
- ≡ SCUPPER

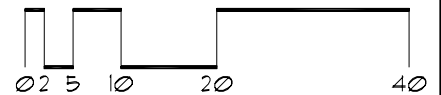
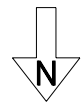

# Roof Corrective Action

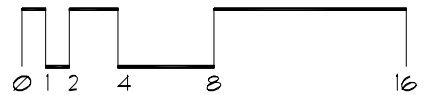
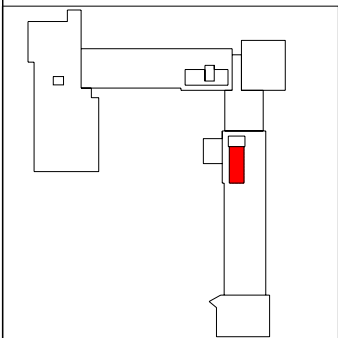
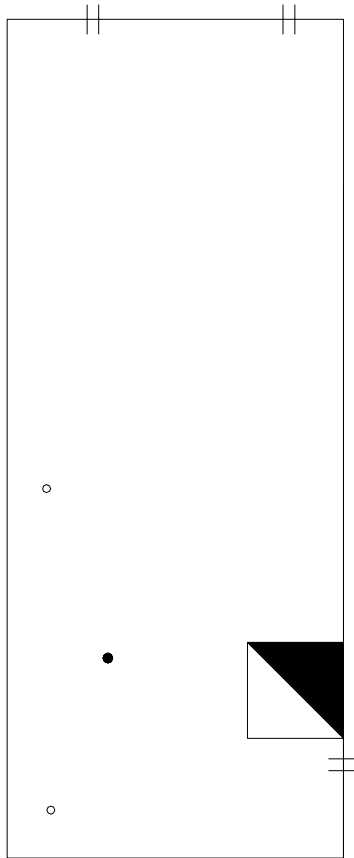

# Roof Corrective Action

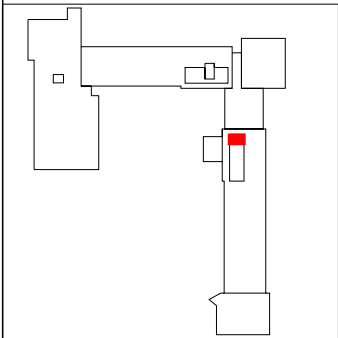
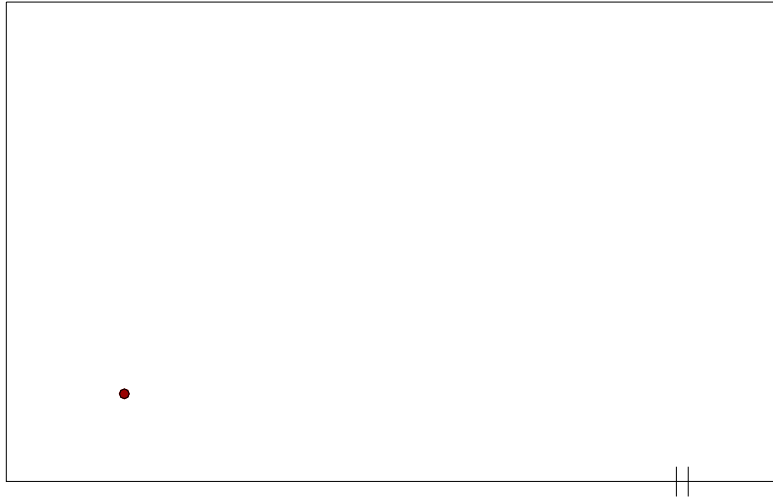

- SYMBOLS KEY
- ROOF DRAIN
  - Ⓢ DEFECT-REPAIR
  - || SCUPPER

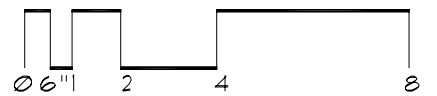
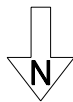

# Roof Corrective Action

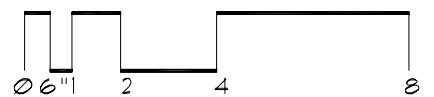
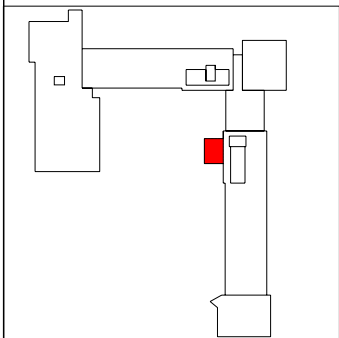
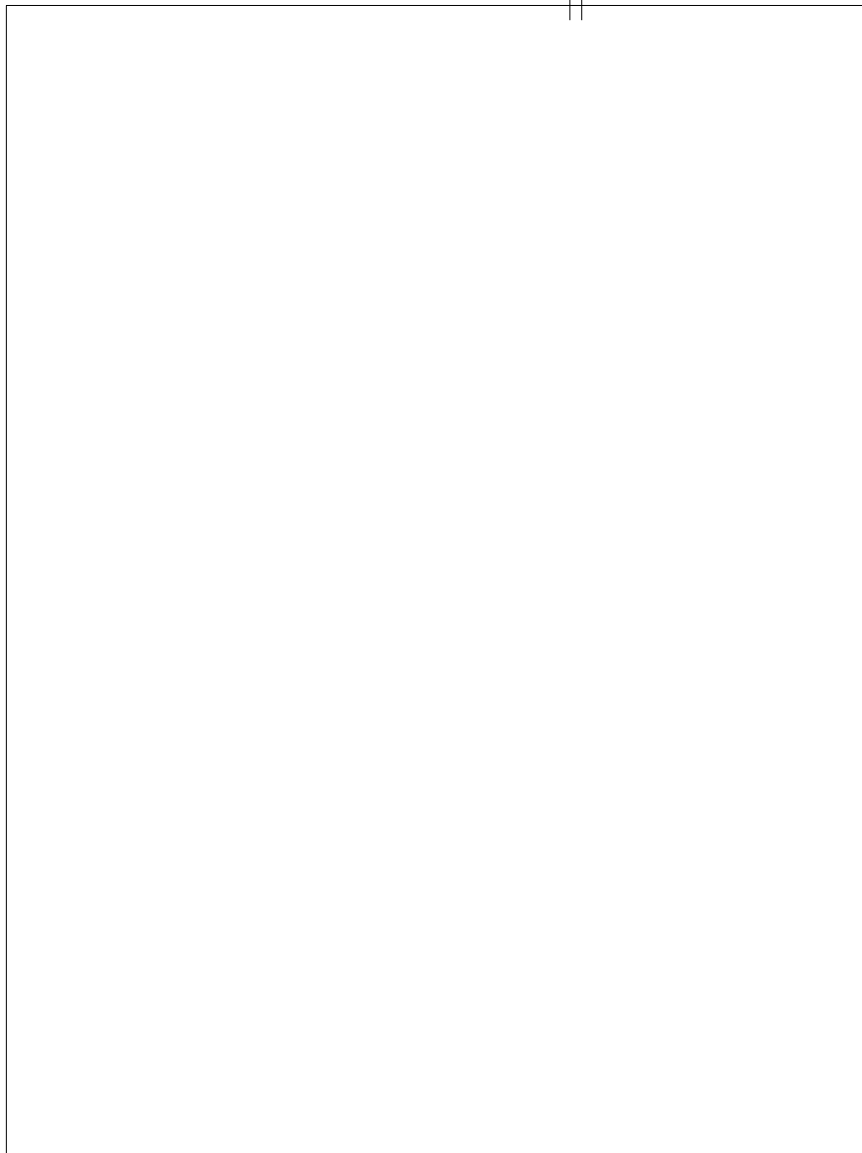

# Roof Corrective Action

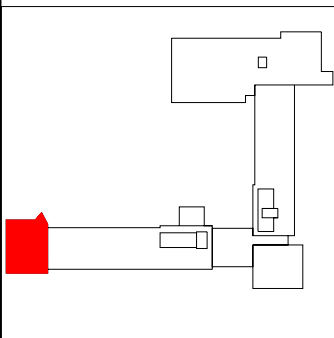
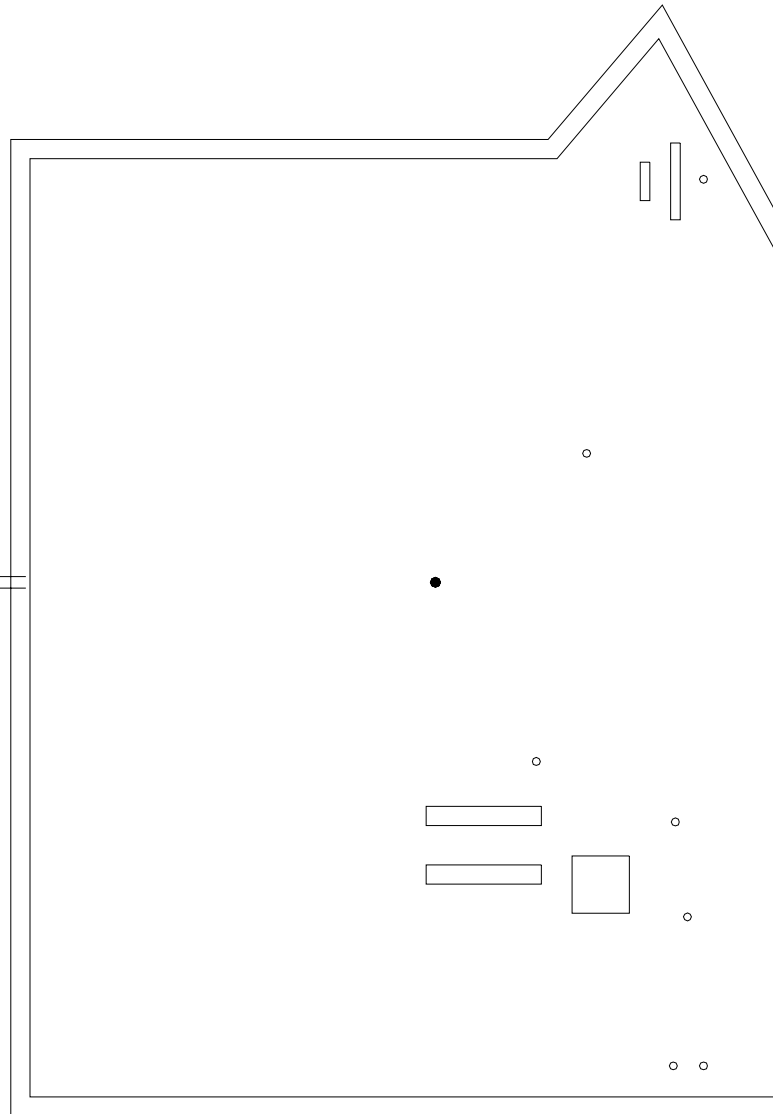

## SYMBOLS KEY

- ROOF CURB
- VENT STACK
- † SCUPPER

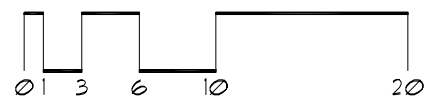

# Roof ID

**Building:** 068 - Centennial Hall - (614 Delaware St SE)

**Total Area:** 48,176 sf

<b>A</b>	2,380 sf	<b>E</b>	1,750 sf	<b>I</b>	160 sf	<b>M</b>	4,515 sf	<b>Q</b>	2,380 sf	<b>U</b>	6,790 sf
<b>B</b>	1,750 sf	<b>F</b>	2,380 sf	<b>J</b>	240 sf	<b>N</b>	2,280 sf	<b>R</b>	630 sf	<b>V</b>	79 sf
<b>C</b>	36 sf	<b>G</b>	454 sf	<b>K</b>	240 sf	<b>O</b>	4,515 sf	<b>S</b>	630 sf	<b>W</b>	79 sf
<b>D</b>	36 sf	<b>H</b>	5,431 sf	<b>L</b>	160 sf	<b>P</b>	169 sf	<b>T</b>	2,380 sf	<b>X</b>	79 sf

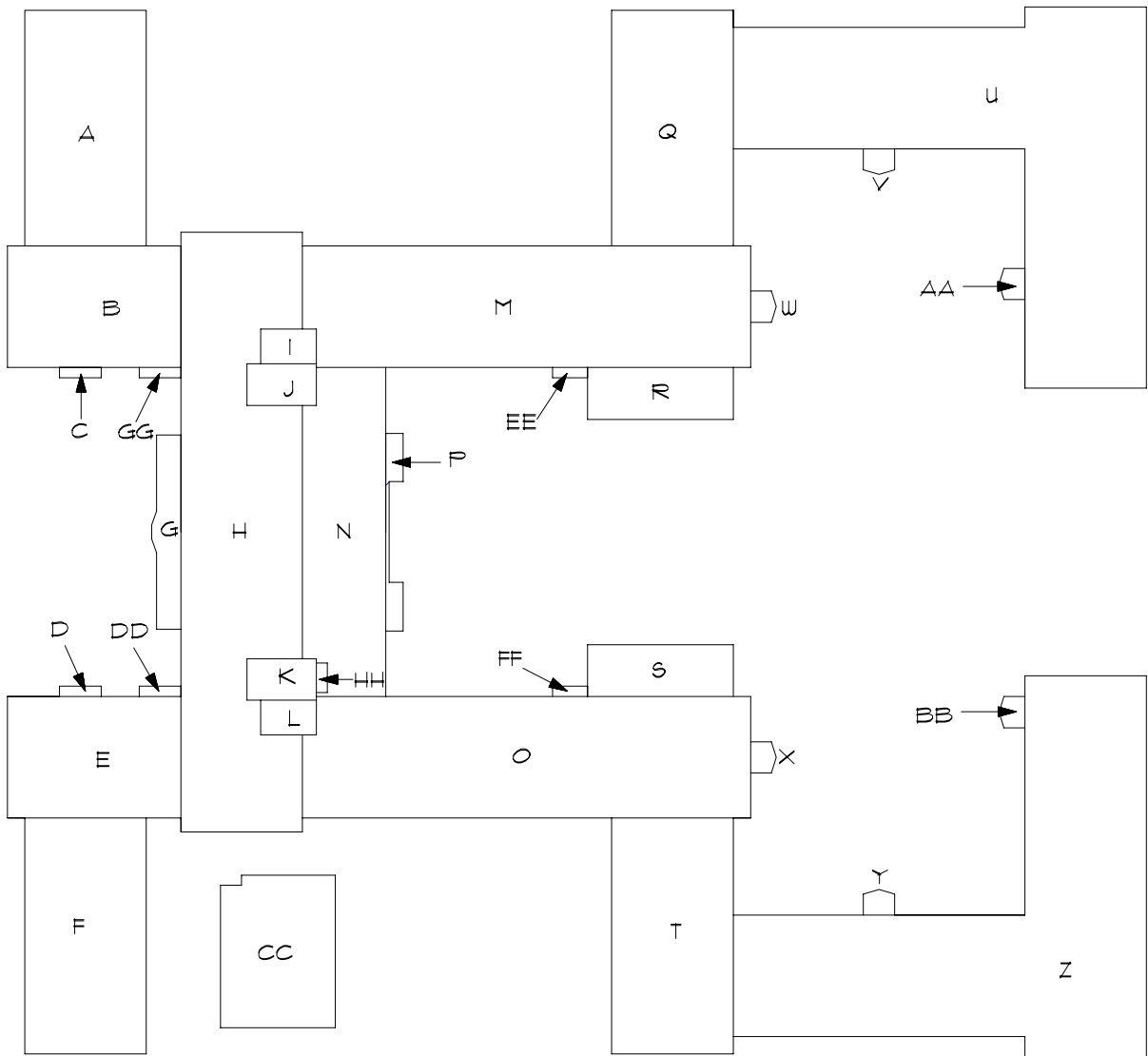

# Roof ID

Building: 068 - Centennial Hall - (614 Delaware St SE)

Total Area: 48,176 sf

<u>Y</u>	<u>79 sf</u>	<u>CC</u>	<u>1,434 sf</u>	<u>GG</u>	<u>36 sf</u>
<u>Z</u>	<u>6,790 sf</u>	<u>DD</u>	<u>36 sf</u>	<u>HH</u>	<u>40 sf</u>
<u>AA</u>	<u>79 sf</u>	<u>EE</u>	<u>30 sf</u>		
<u>BB</u>	<u>79 sf</u>	<u>FF</u>	<u>30 sf</u>		

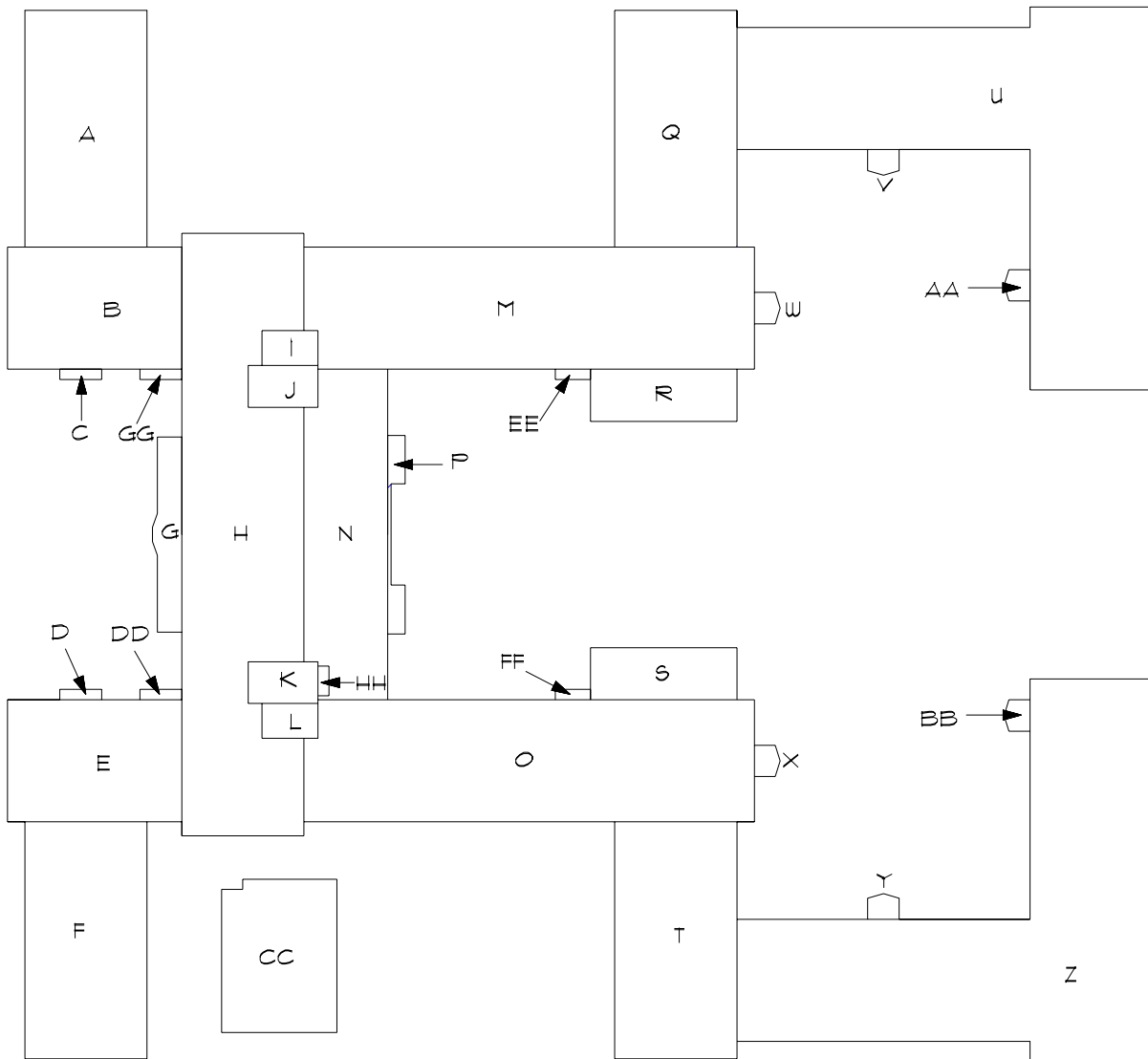



# Roof Corrective Action

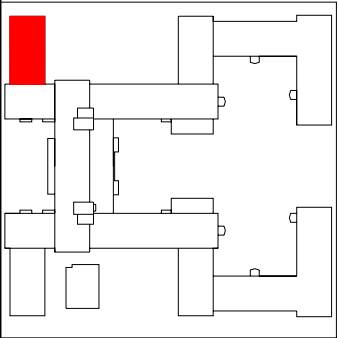
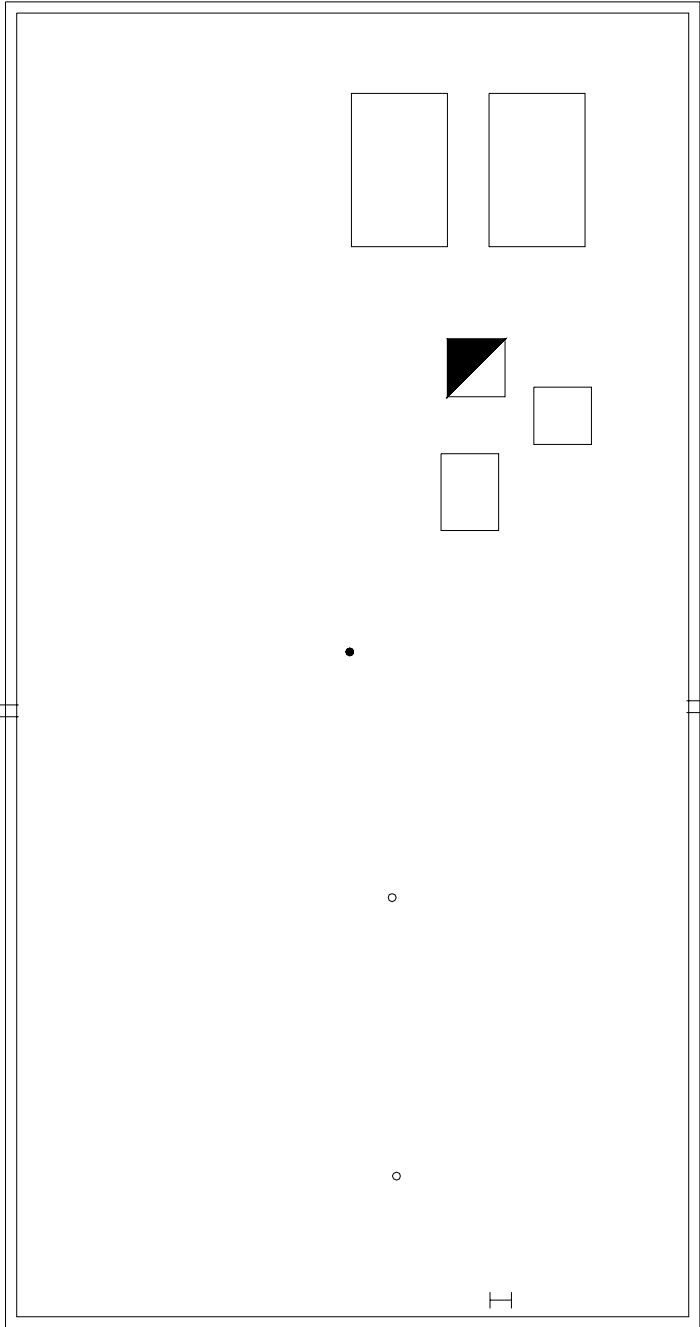

### SYMBOLS KEY

- ROOF CURB
- ROOF DRAIN
- VENT STACK
- ▣ CHIMNEY
- ⊕ SCUPPER

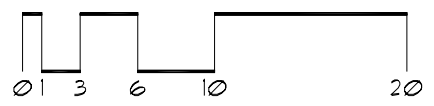

# Roof Corrective Action

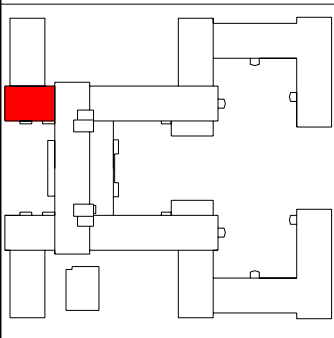
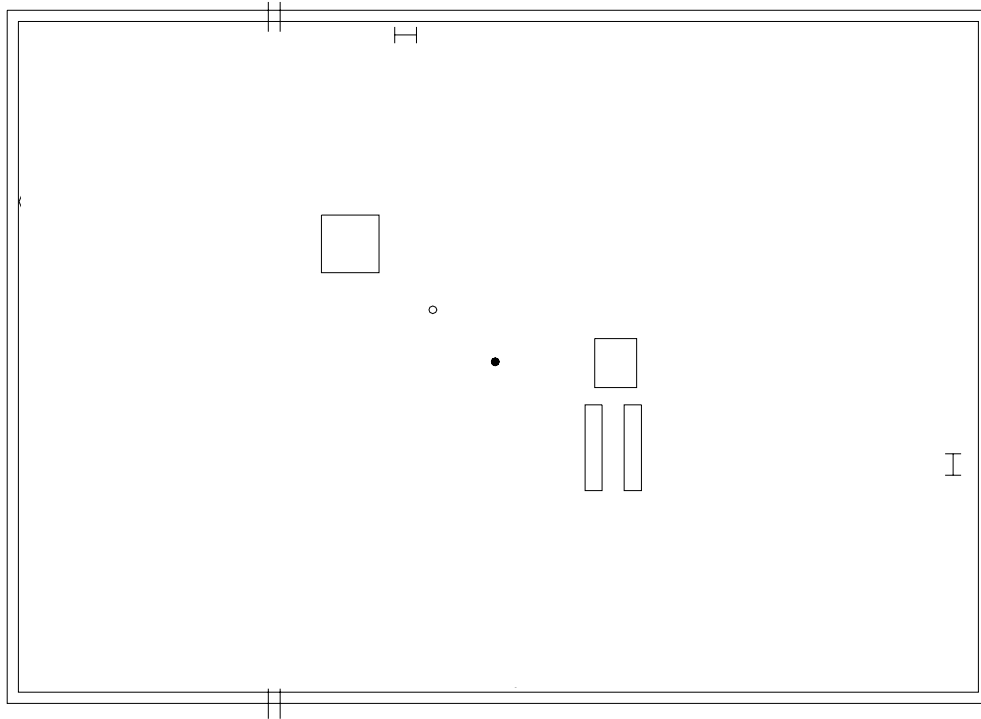

## SYMBOLS KEY

- ROOF CURB
- ROOF DRAIN
- VENT STACK
- ⊕ SCUPPER
- ⊙ DEFECT-REPAIR
- ⊖ DEFECT-NO REPAIR
- I LADDER

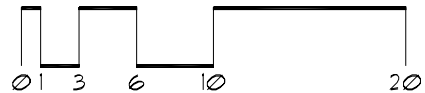

# Roof Corrective Action

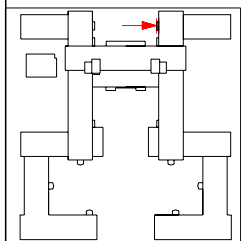
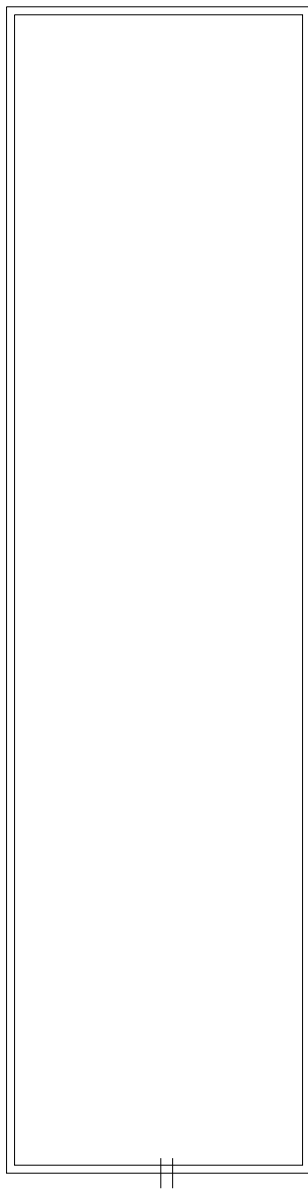

SYMBOLS KEY  
|| SCUPPER  
ⓐ DEFECT-REPAIR

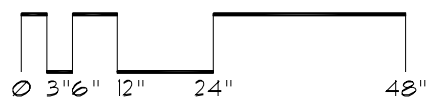

# Roof Corrective Action

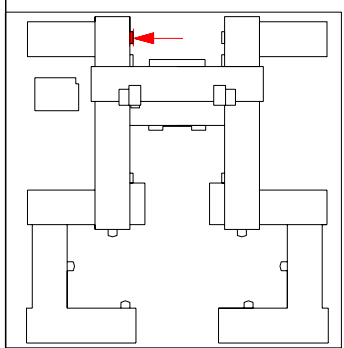
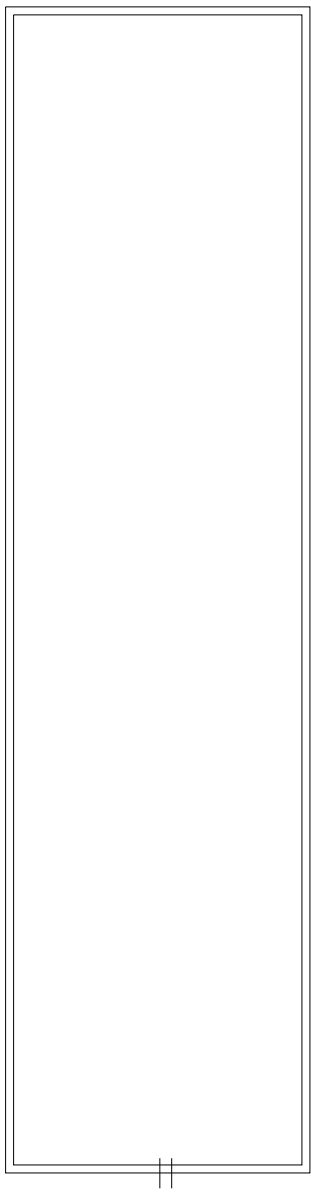

SYMBOLS KEY  
|| SCUPPER

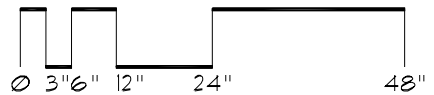

# Roof Corrective Action

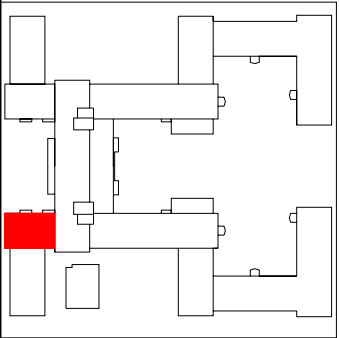
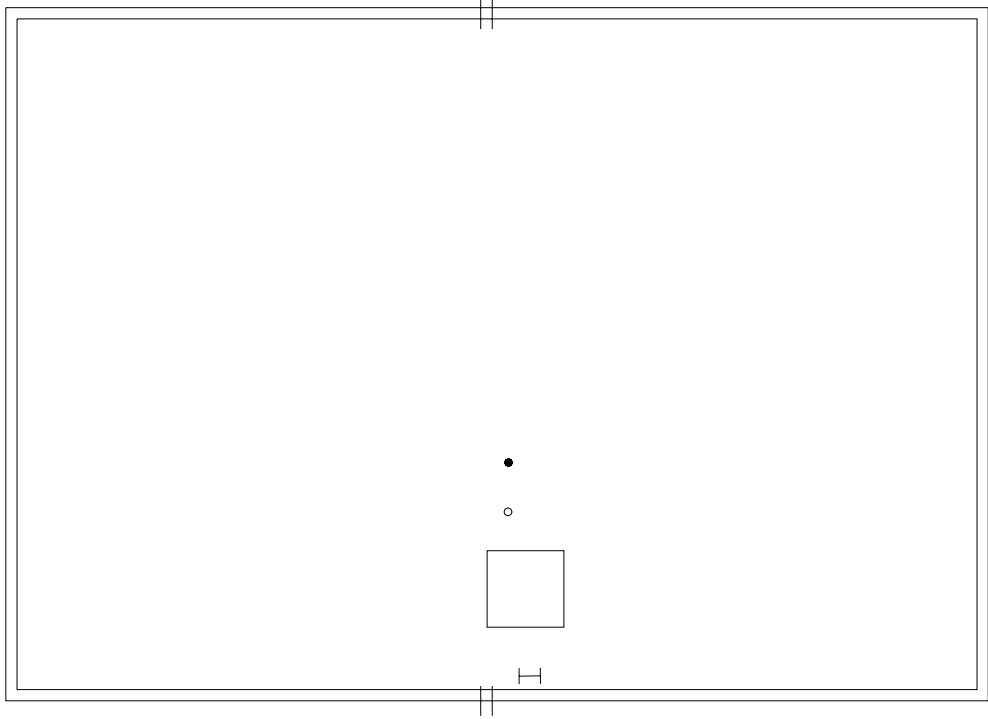

**SYMBOLS KEY**

- ROOF CURB
- ROOF DRAIN
- VENT STACK
- ⊥ SCUPPER
- I LADDER
- Ⓡ DEFECT-REPAIR
- Ⓢ DEFECT-NO REPAIR

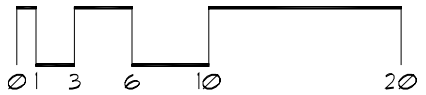

# Roof Corrective Action

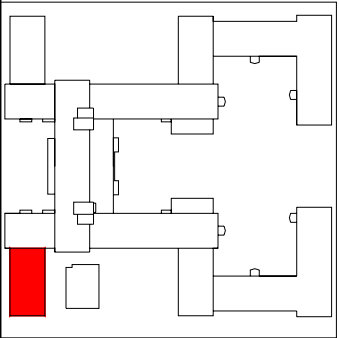
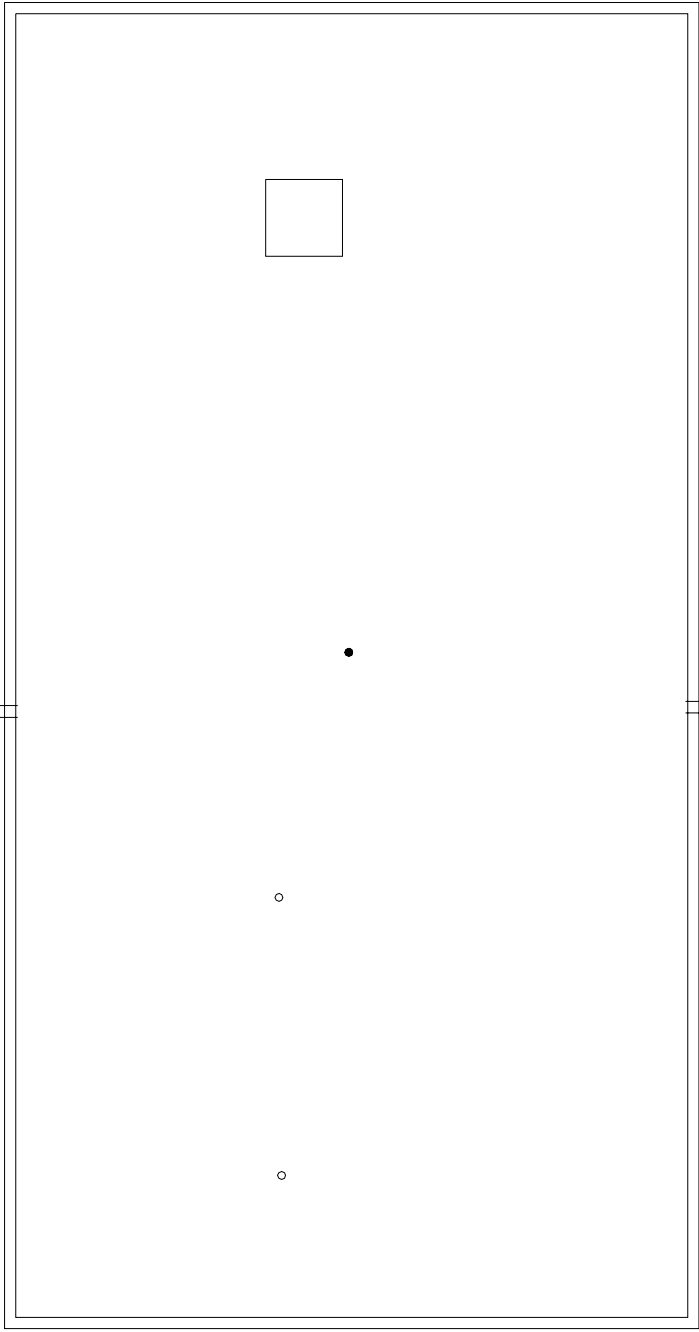

## SYMBOLS KEY

- ROOF CURB
- ROOF DRAIN
- VENT STACK
- †† SCUPPER

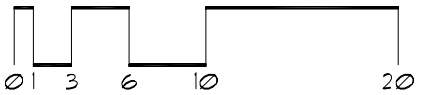

# Roof Corrective Action

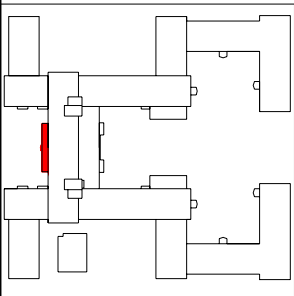
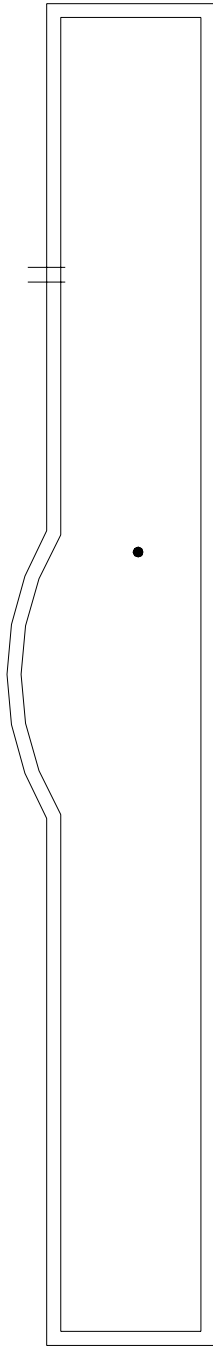

SYMBOLS KEY  
● ROOF DRAIN  
⊕ SCUPPER

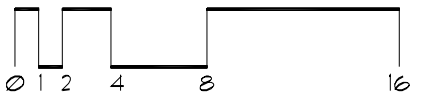

# Roof Corrective Action

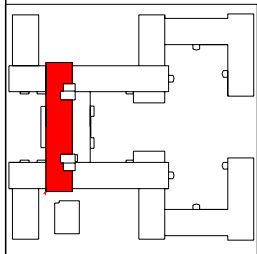
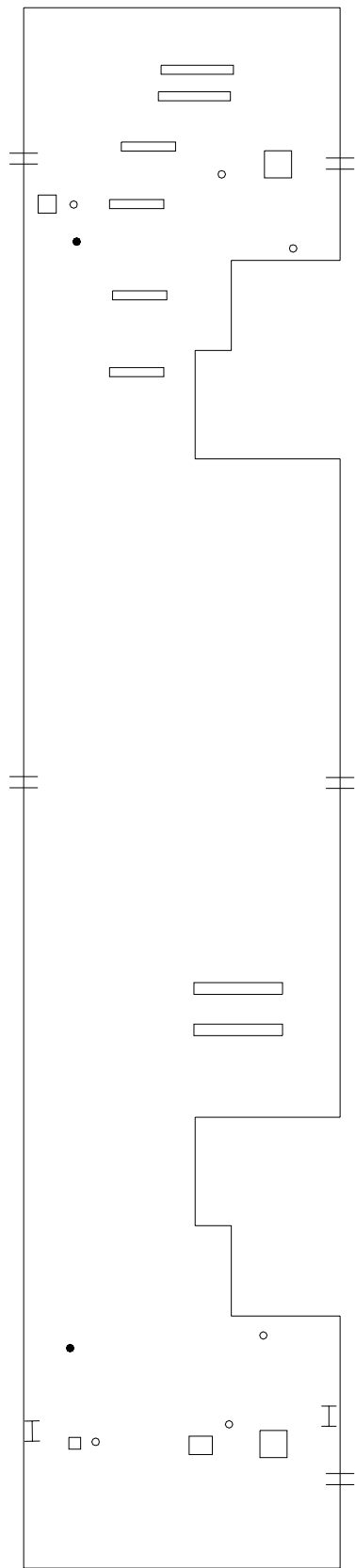

**SYMBOLS KEY**

□	ROOF CURB
●	ROOF DRAIN
○	VENT STACK
†	SCUPPER
⊖	DEFECT-NO REPAIR
⊕	DEFECT-REPAIR
I	LADDER

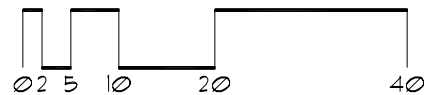



# Roof Corrective Action

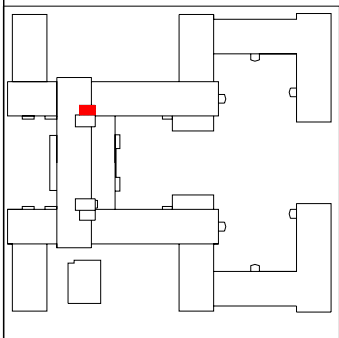
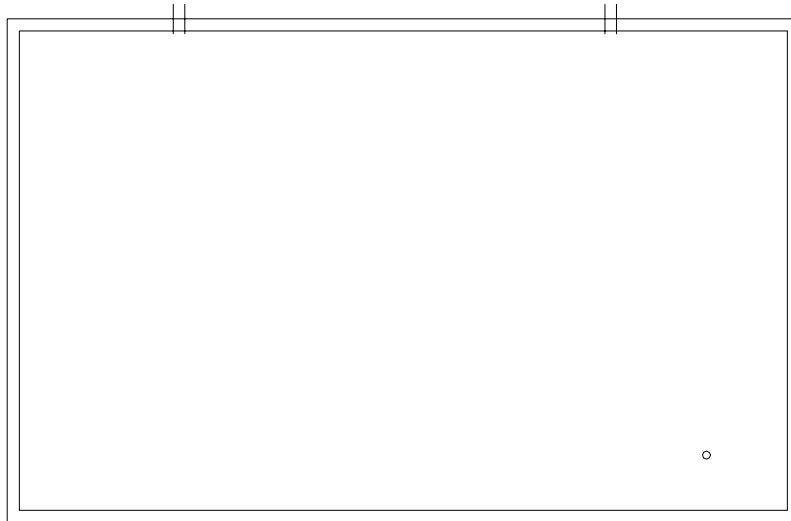

## SYMBOLS KEY

- || SCUPPER
- o VENT STACK

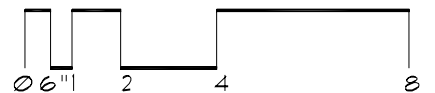

# Roof Corrective Action

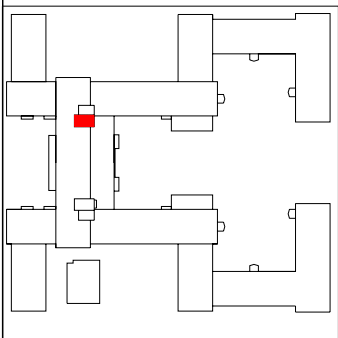
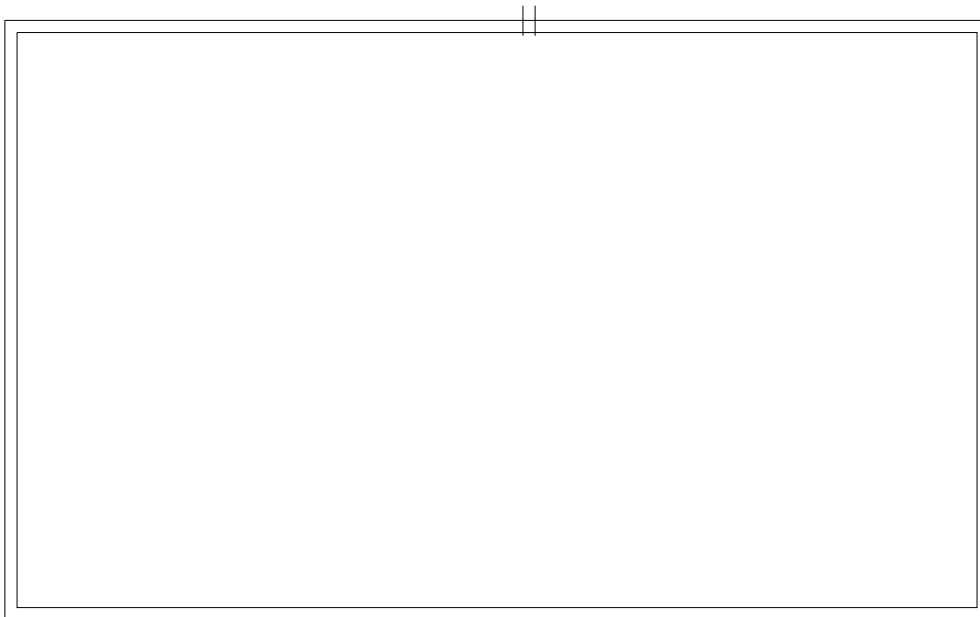

SYMBOLS KEY  
|| SCUPPER  
Ⓢ DEFECT-REPAIR

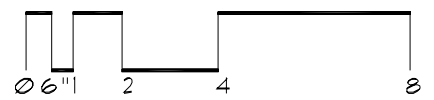

# Roof Corrective Action

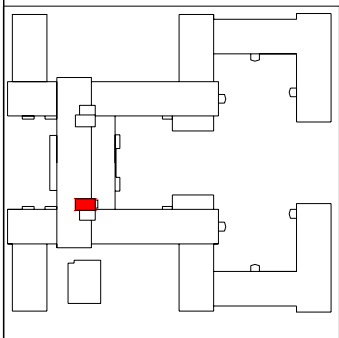
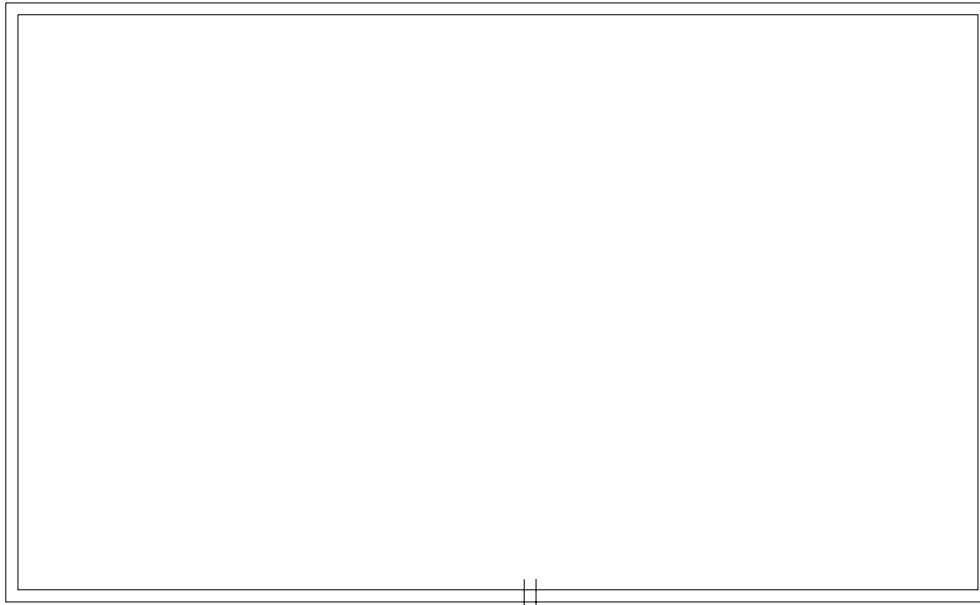

SYMBOLS KEY  
⦚ SCUPPER  
Ⓜ DEFECT-REPAIR

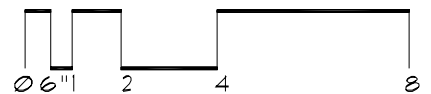

# Roof Corrective Action

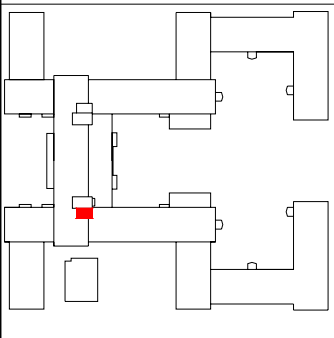

SYMBOLS KEY  
++ SCUPPER  
① DEFECT-REPAIR

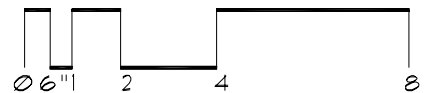

# Roof Corrective Action

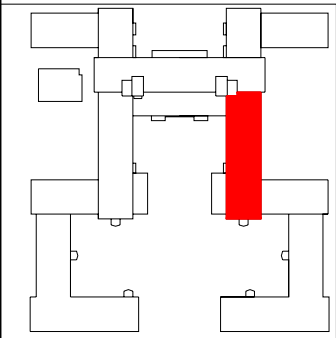
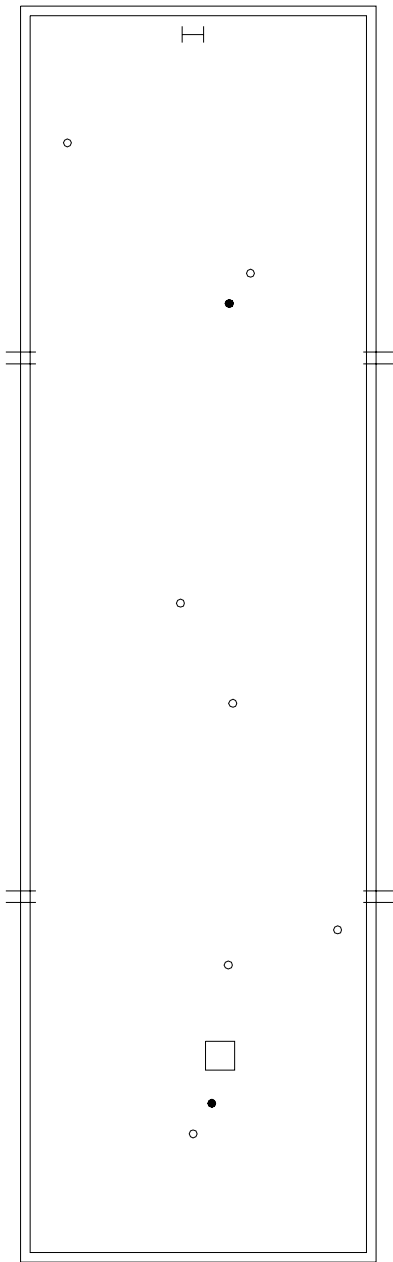

## SYMBOLS KEY

- ROOF CURB
- ROOF DRAIN
- VENT STACK
- ⊕ SCUPPER
- ⊖ DEFECT-NO REPAIR

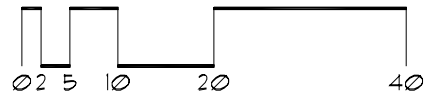

# Roof Corrective Action

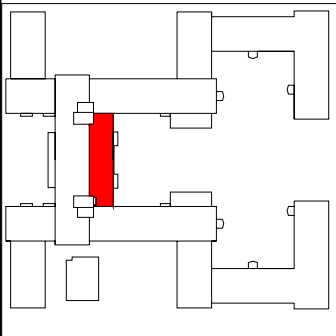
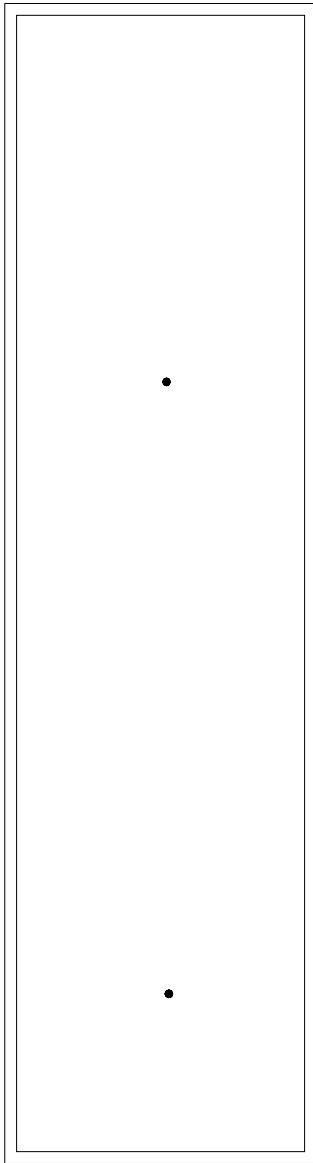

SYMBOLS KEY  
• ROOF DRAIN

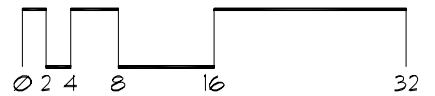

# Roof Corrective Action

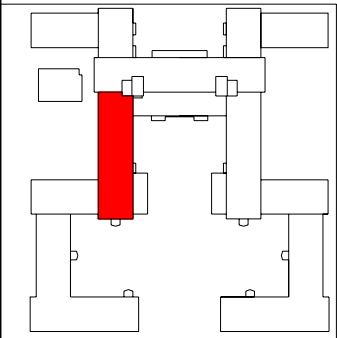
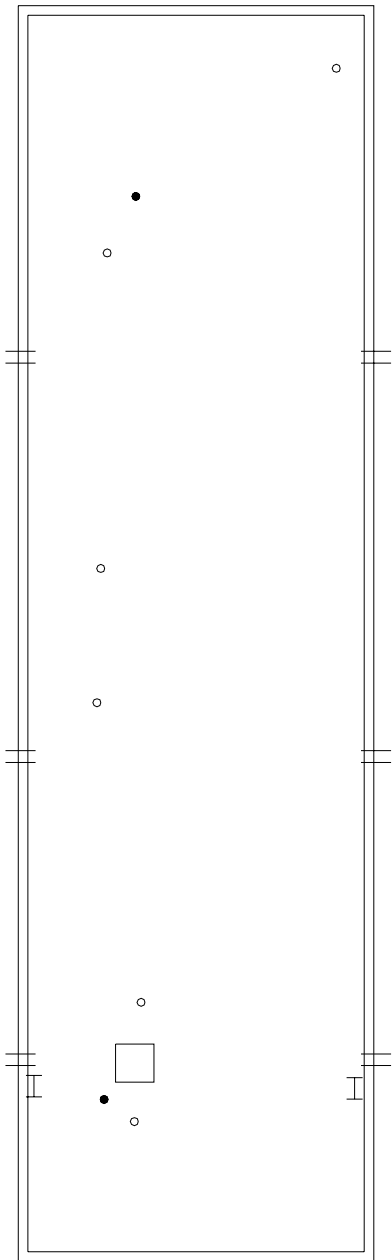

- SYMBOLS KEY**
- ROOF CURB
  - ROOF DRAIN
  - VENT STACK
  - ⊕ SCUPPER
  - I LADDER
  - ⊖ DEFECT-NO REPAIR
  - ⊕ DEFECT-REPAIR

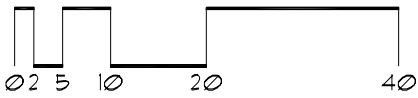

# Roof Corrective Action

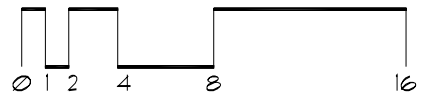
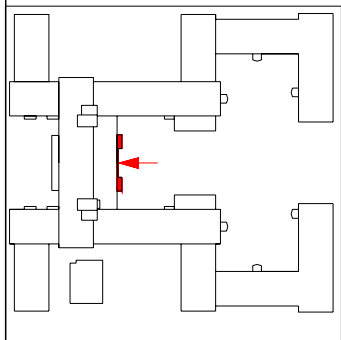



# Roof Corrective Action

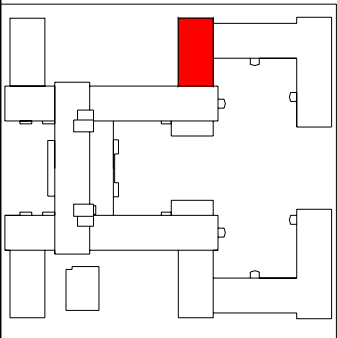
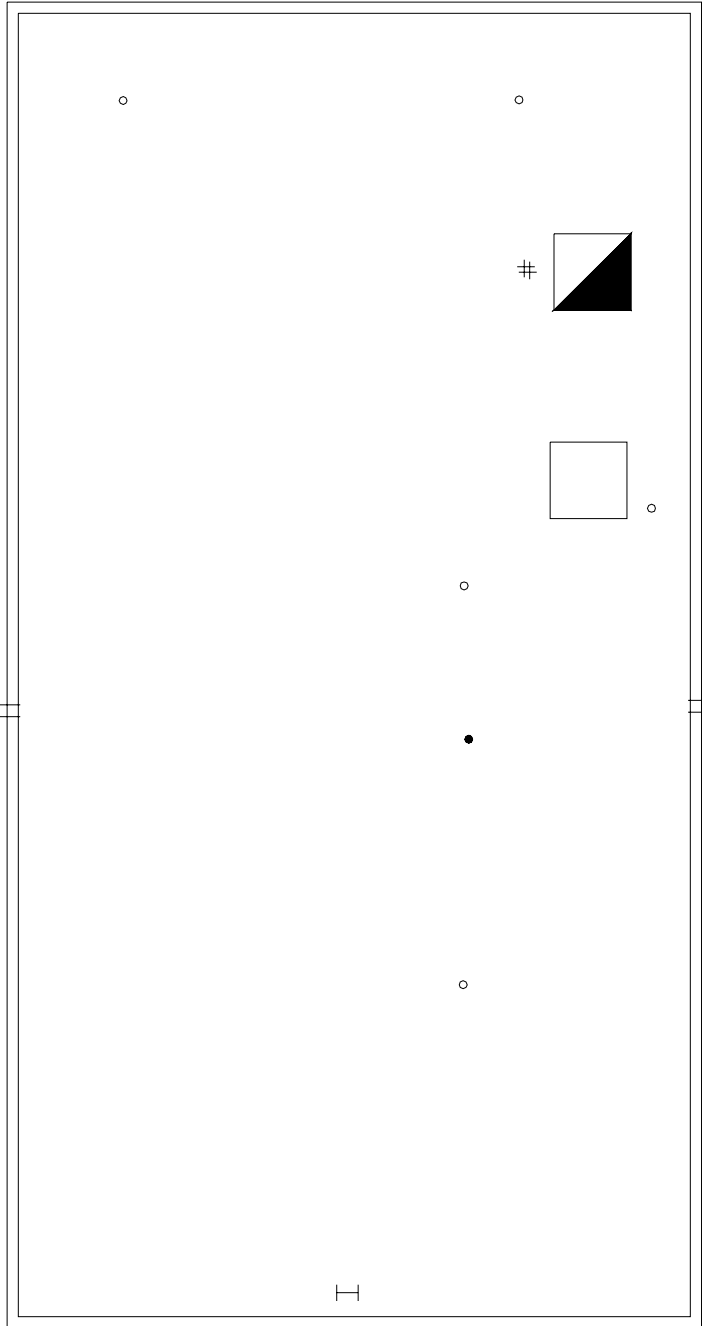

- SYMBOLS KEY**
- ROOF CURB
  - ROOF DRAIN
  - VENT STACK
  - ⊕ SCUPPER
  - ① DEFECT-REPAIR

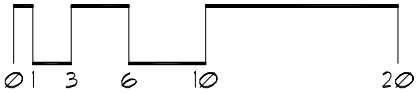

# Roof Corrective Action

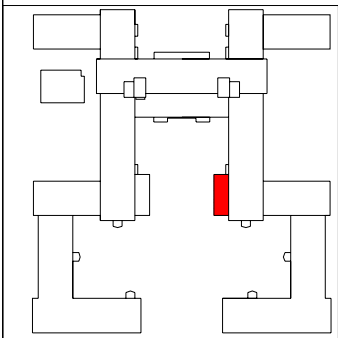
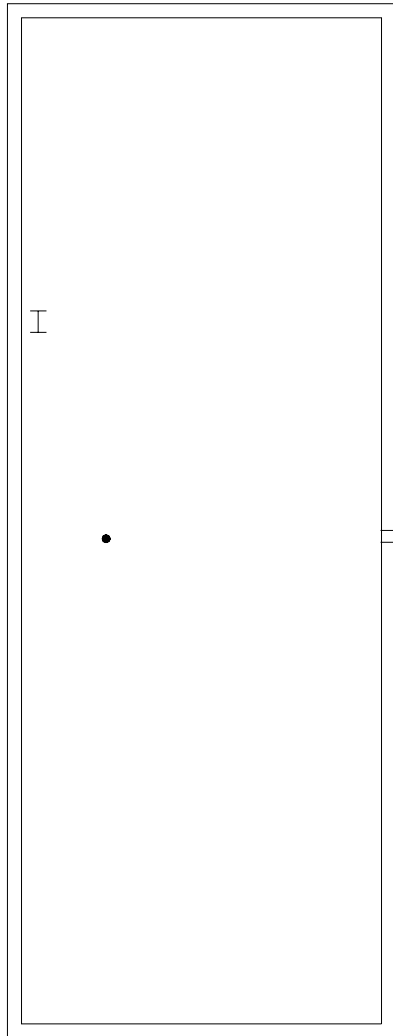

## SYMBOLS KEY

- ROOF DRAIN
- †† SCUPPER

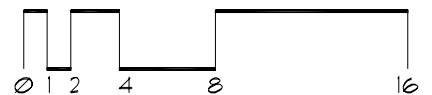

# Roof Corrective Action

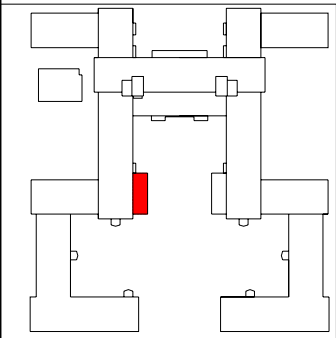
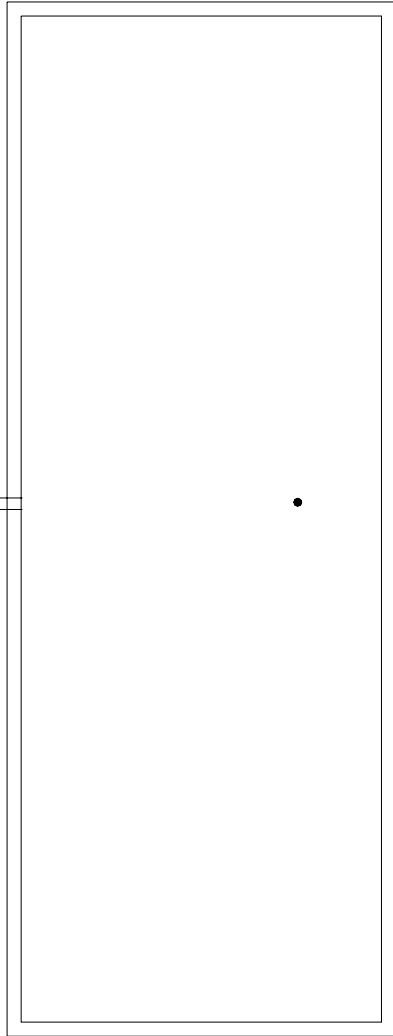

- SYMBOLS KEY
- ROOF DRAIN
  - † SCUPPER
  - Ⓢ DEFECT-REPAIR

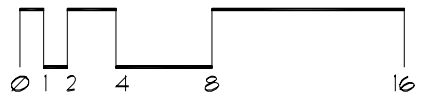

# Roof Corrective Action

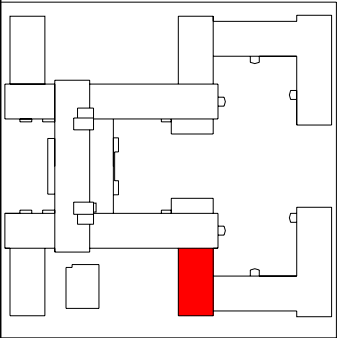
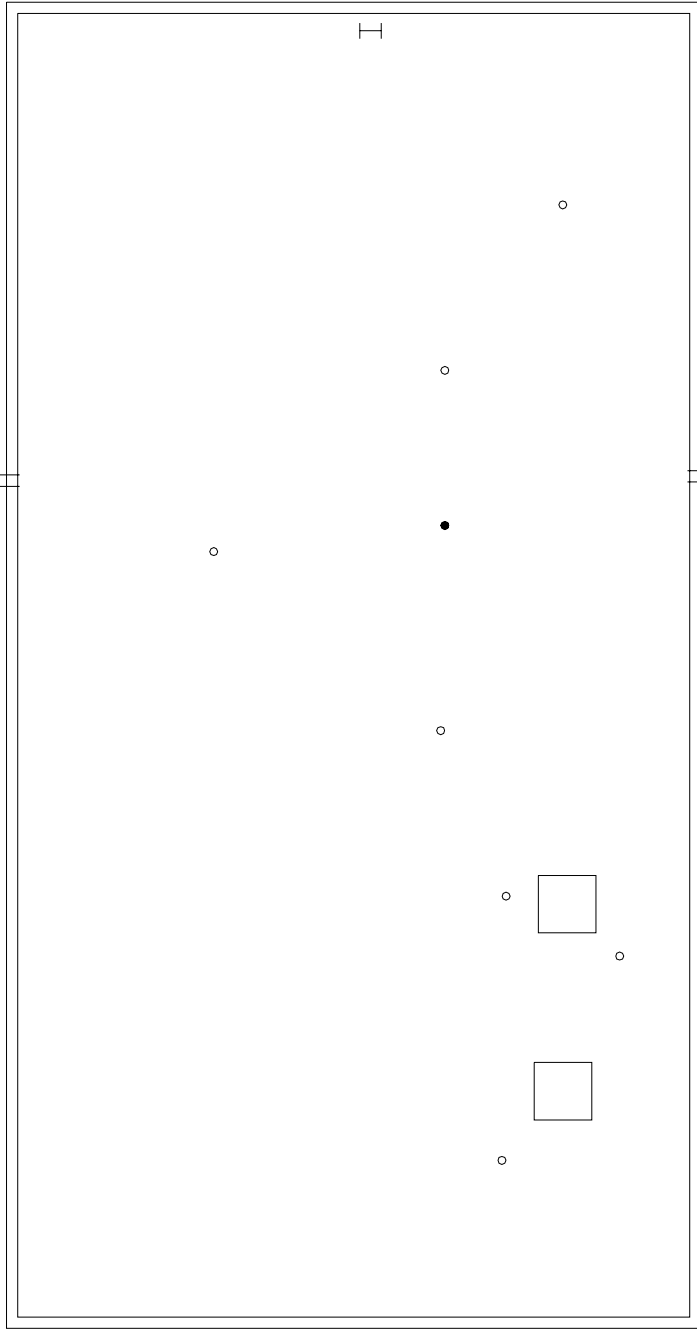

- SYMBOLS KEY**
- ROOF CURB
  - ROOF DRAIN
  - VENT STACK
  - † SCUPPER
  - I LADDER
  - ⊕ DEFECT-REPAIR

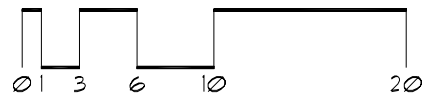

# Roof Corrective Action

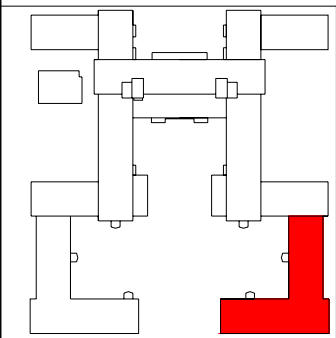
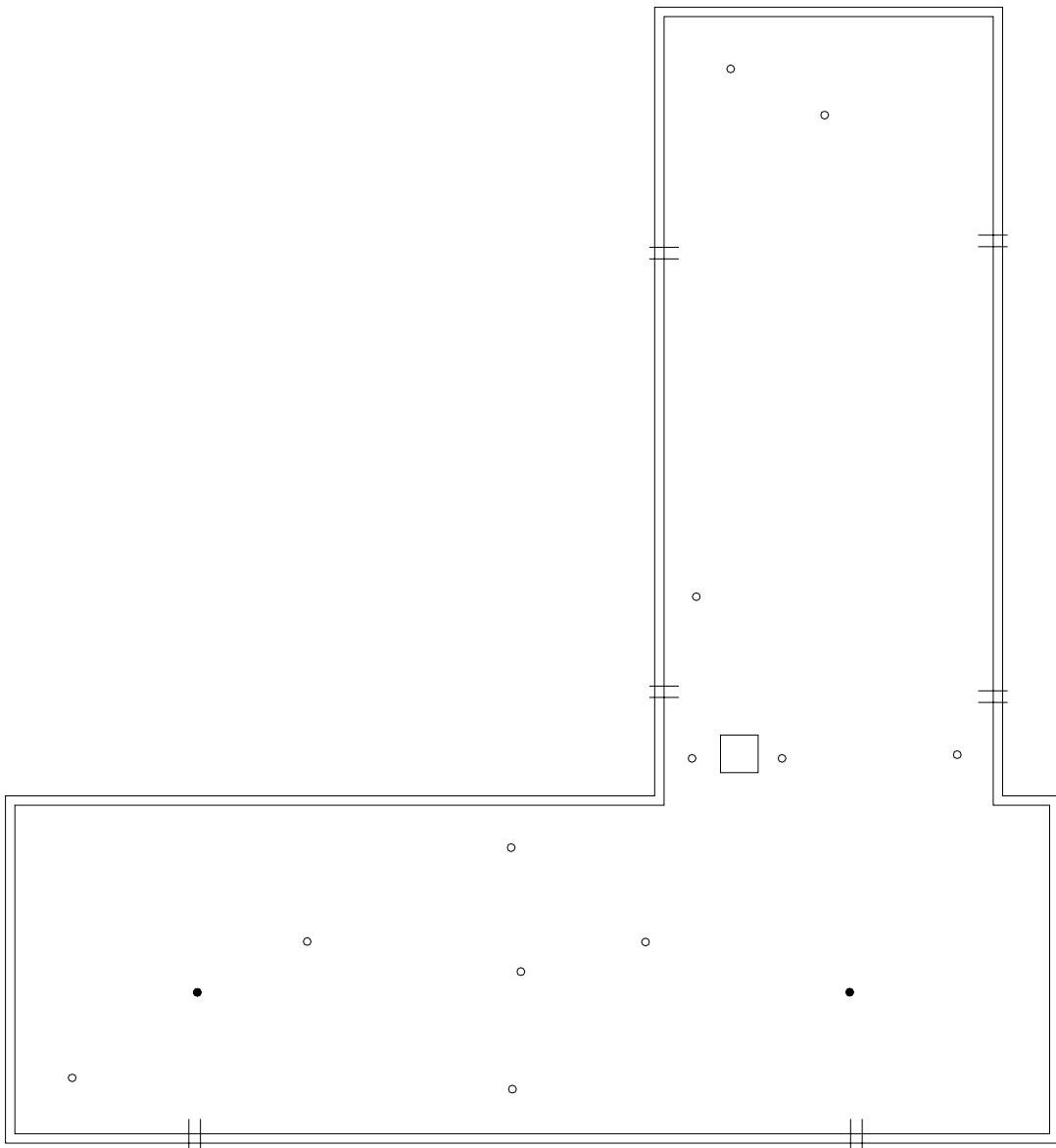

## SYMBOLS KEY

- ROOF CURB
- ROOF DRAIN
- VENT STACK
- ≡ SCUPPER

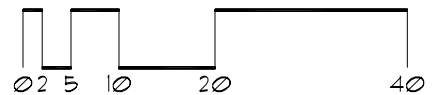

# Roof Corrective Action

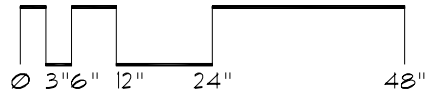
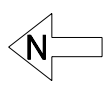
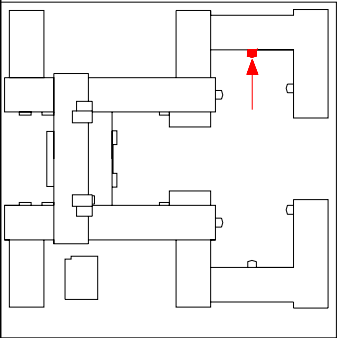
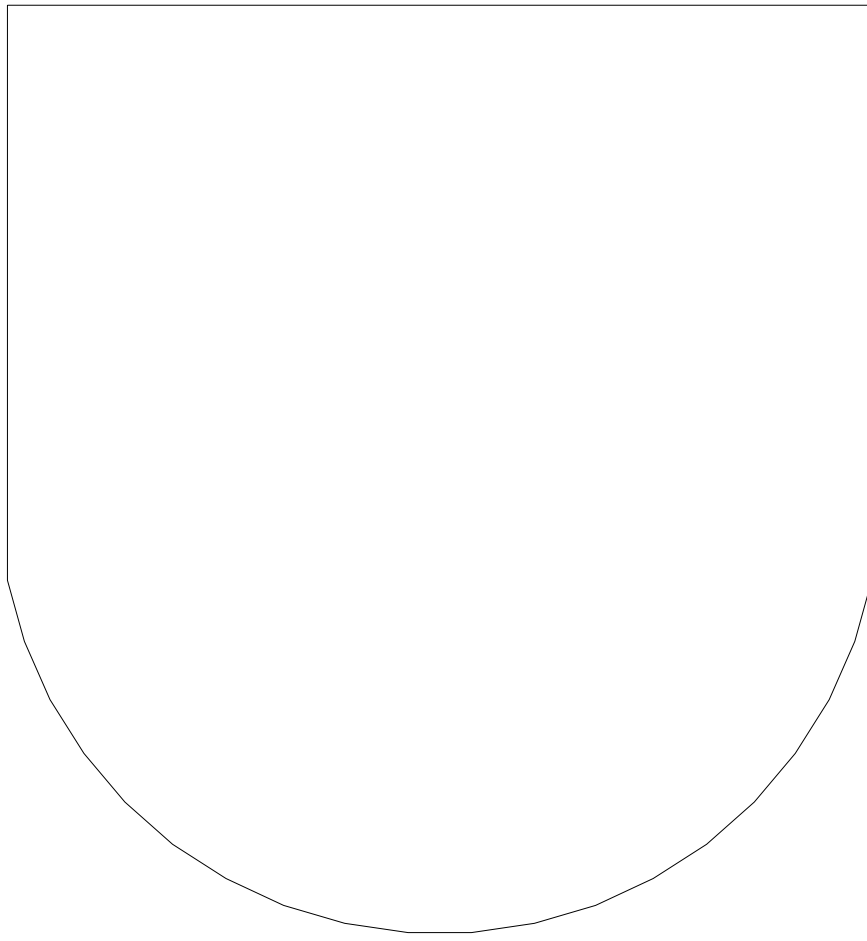

# Roof Corrective Action

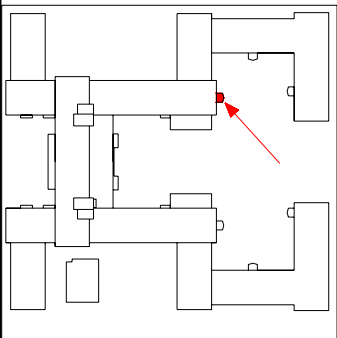
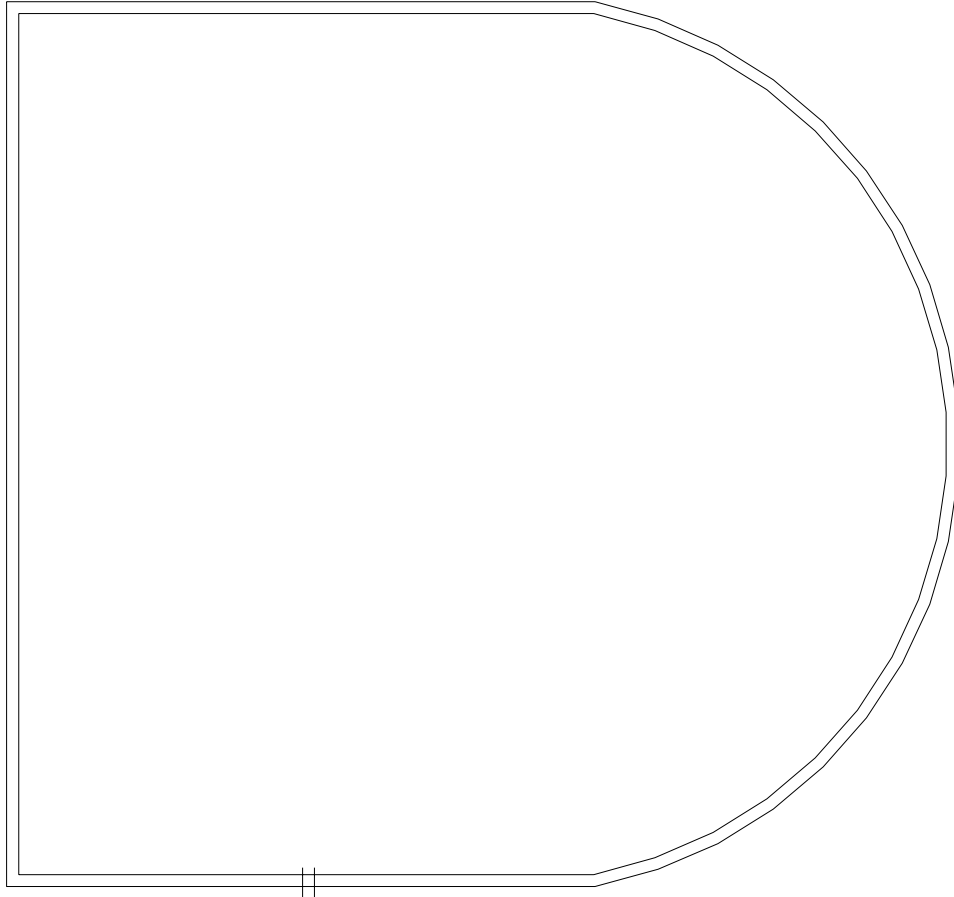

SYMBOLS KEY  
|| SCUPPER

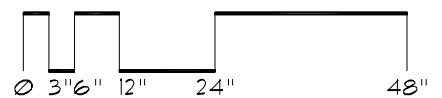

# Roof Corrective Action

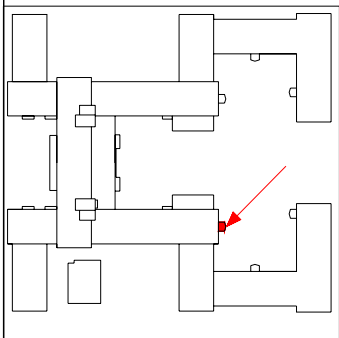

SYMBOLS KEY  
① DEFECT-REPAIR

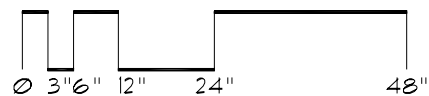



# Roof Corrective Action

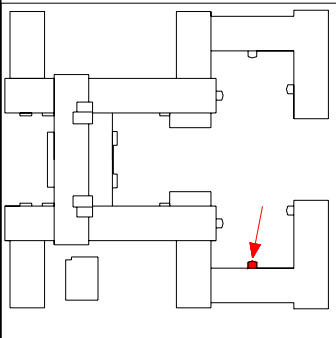
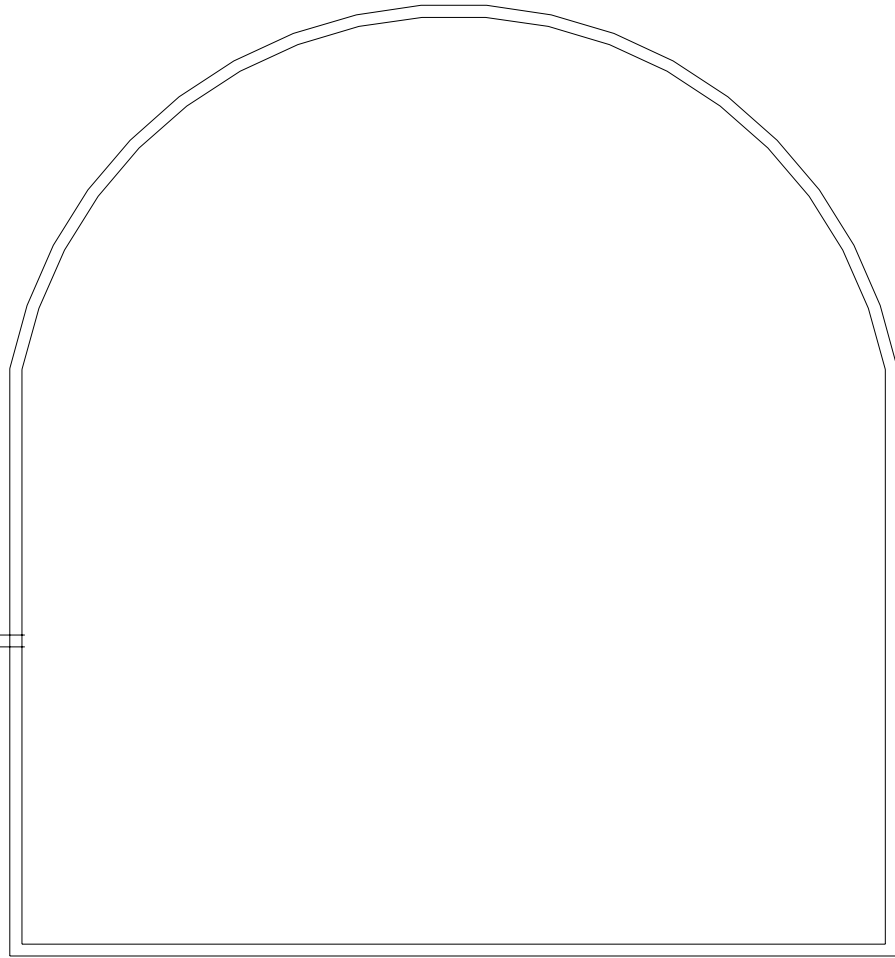

SYMBOLS KEY  
|| SCUPPER

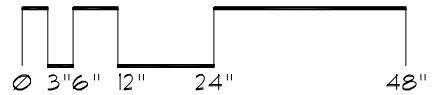

# Roof Corrective Action

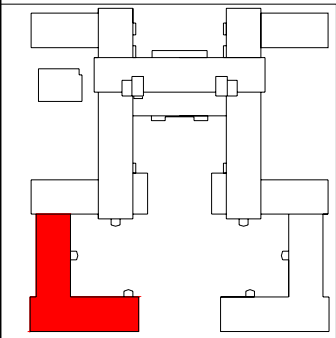
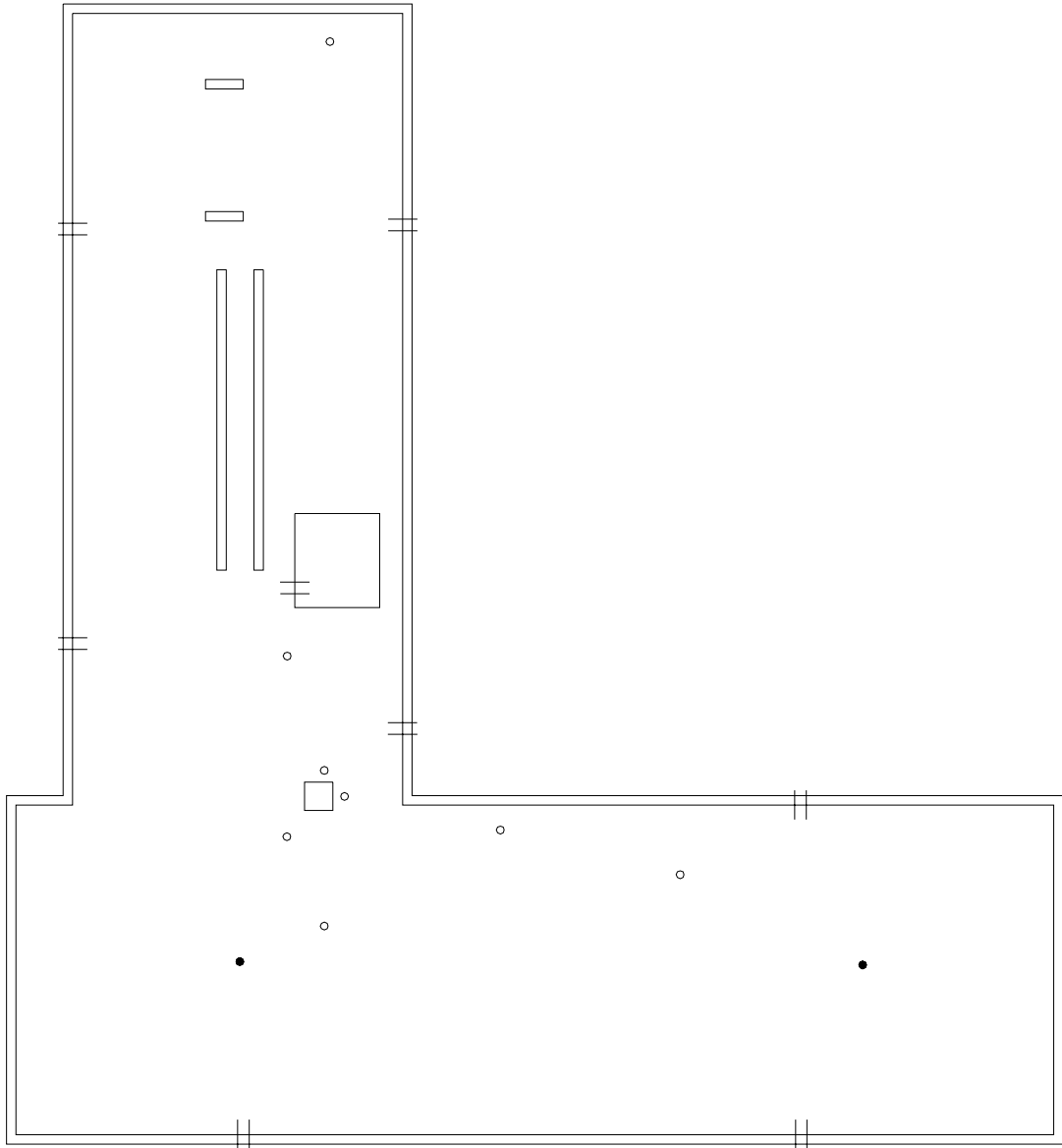

## SYMBOLS KEY

- ROOF CURB
- ROOF DRAIN
- VENT STACK
- ≡ SCUPPER

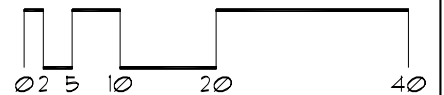

# Roof Corrective Action

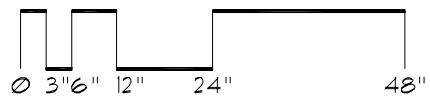
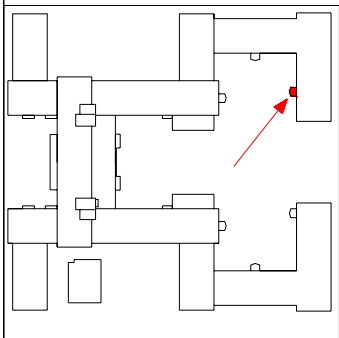
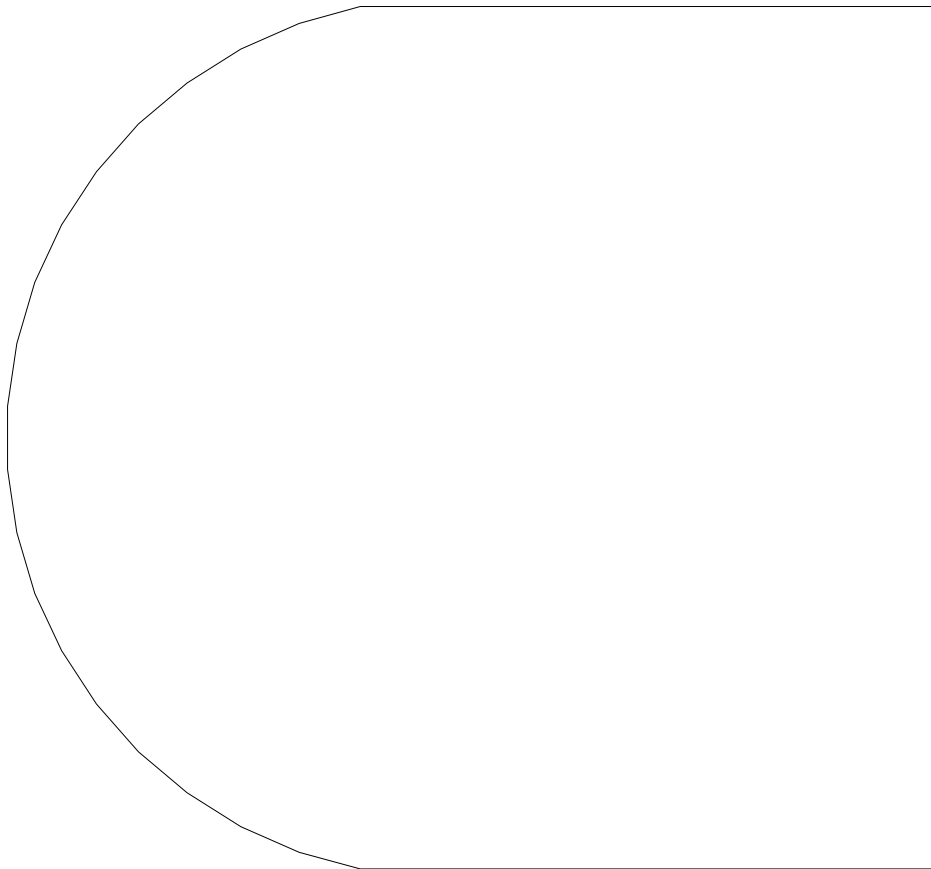

# Roof Corrective Action

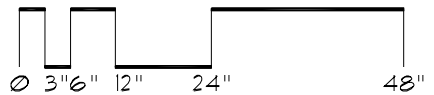
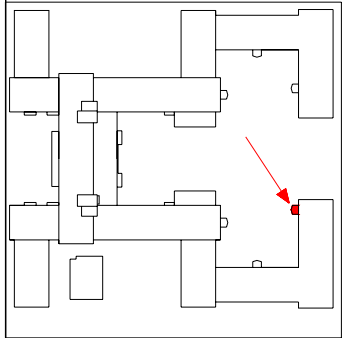

# Roof Corrective Action

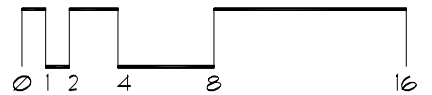
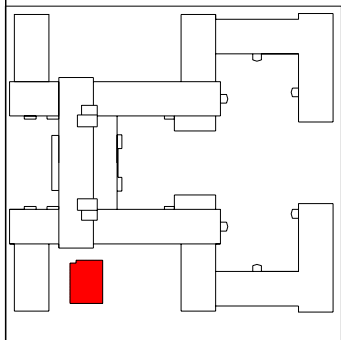
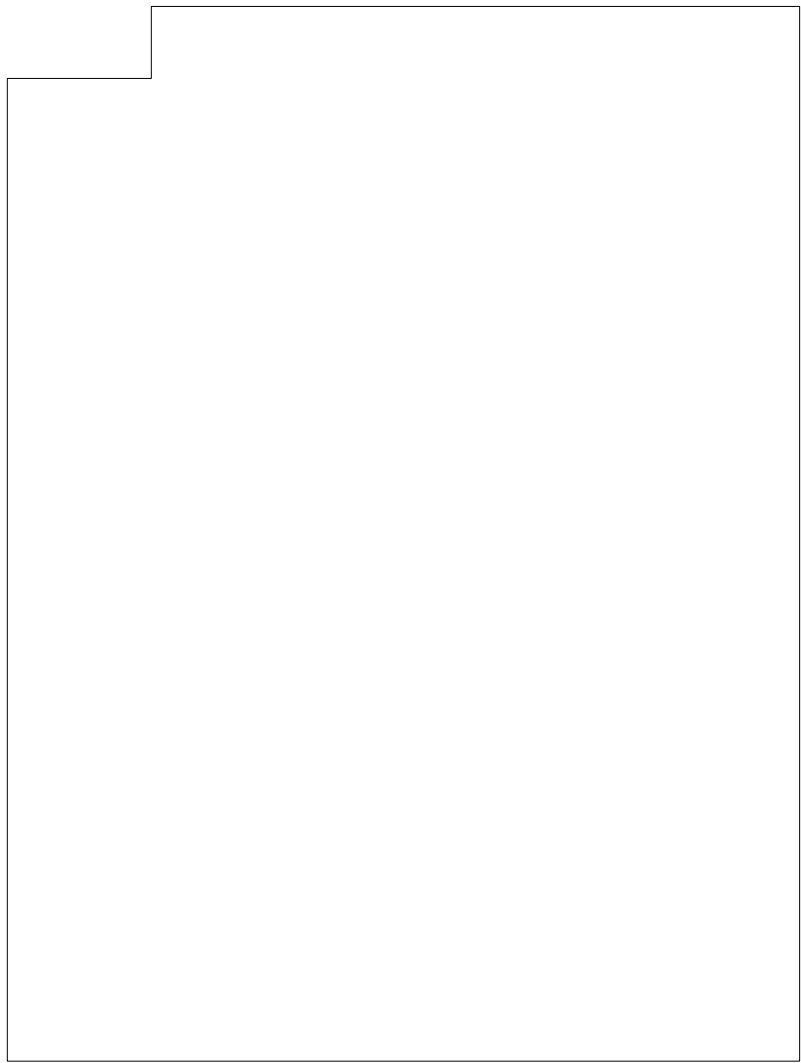

# Roof Corrective Action

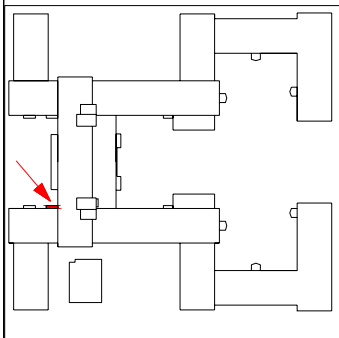

SYMBOLS KEY  
① DEFECT-REPAIR

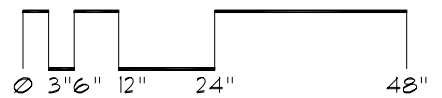

# Roof Corrective Action

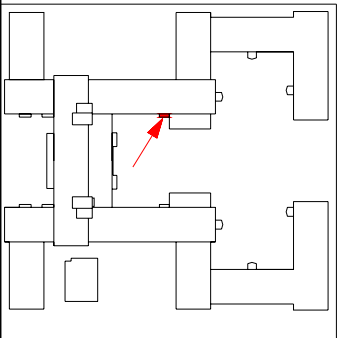

SYMBOLS KEY  
① DEFECT-REPAIR

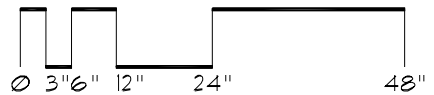

# Roof Corrective Action

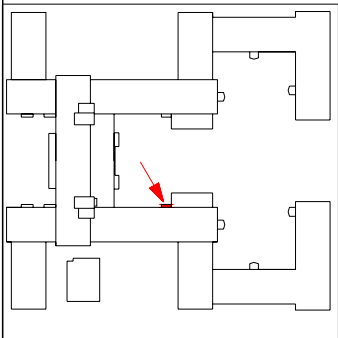
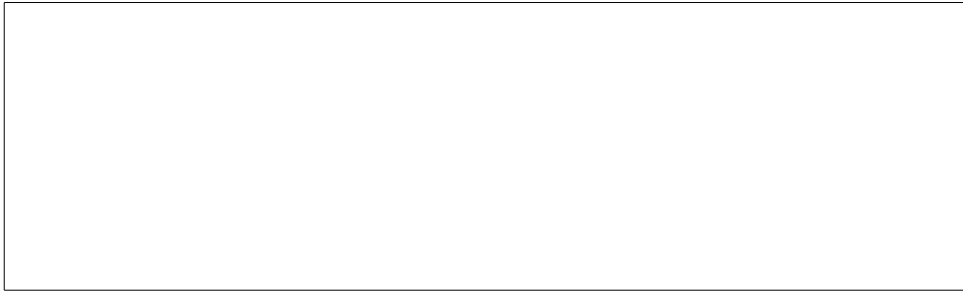

SYMBOLS KEY  
① DEFECT-REPAIR

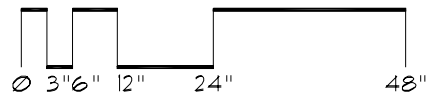



# Roof Corrective Action

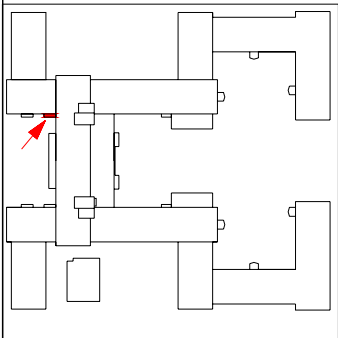
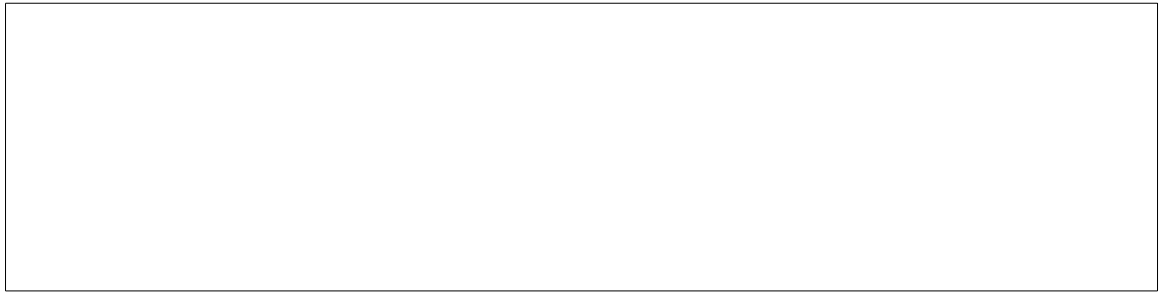

SYMBOLS KEY  
① DEFECT-REPAIR

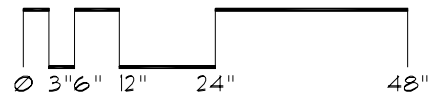

# Roof Corrective Action

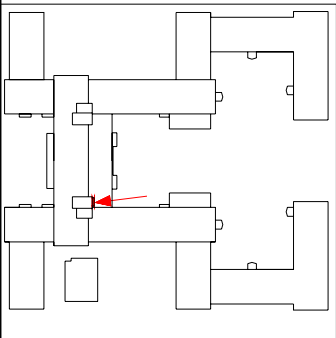
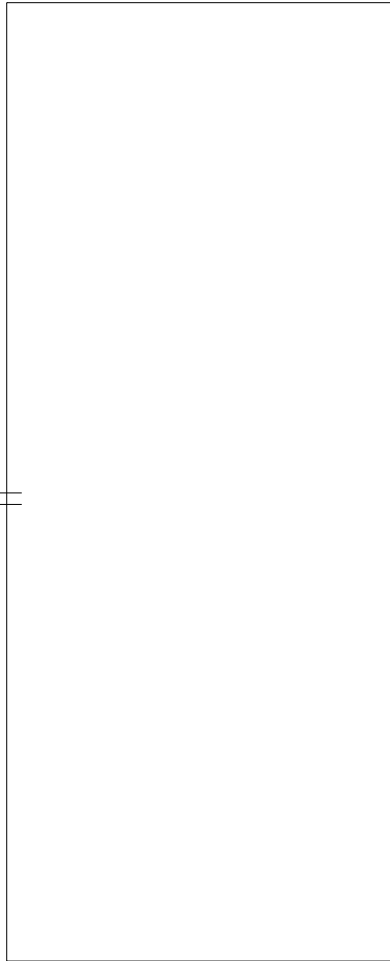

SYMBOLS KEY  
|| SCUPPER

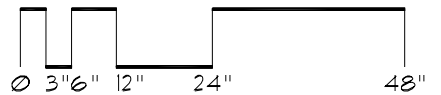

# Roof ID

Building: 150 - Como Community Center - ()

Total Area: 8,740 sf

A 8,740 sf

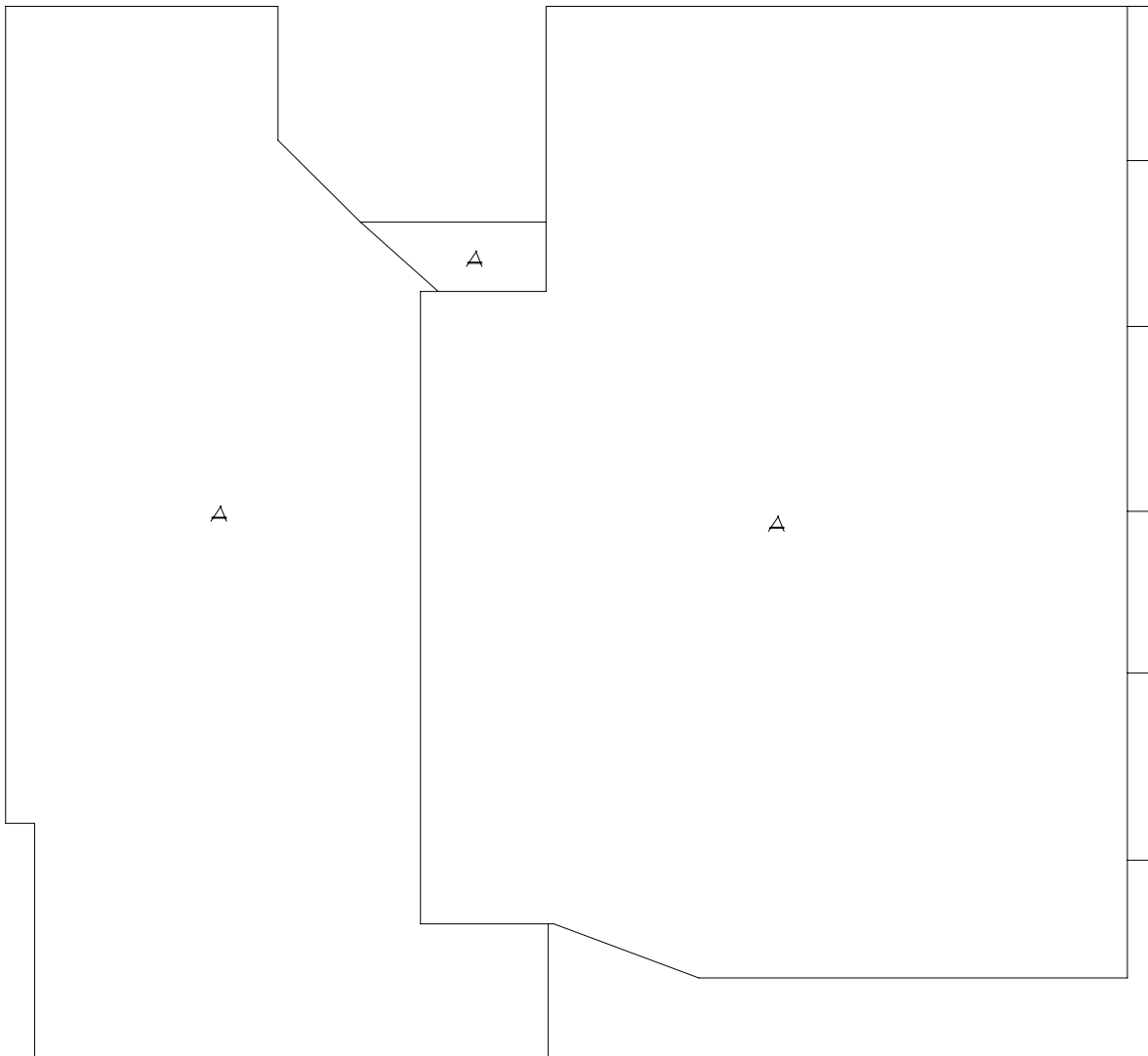

# Roof Corrective Action

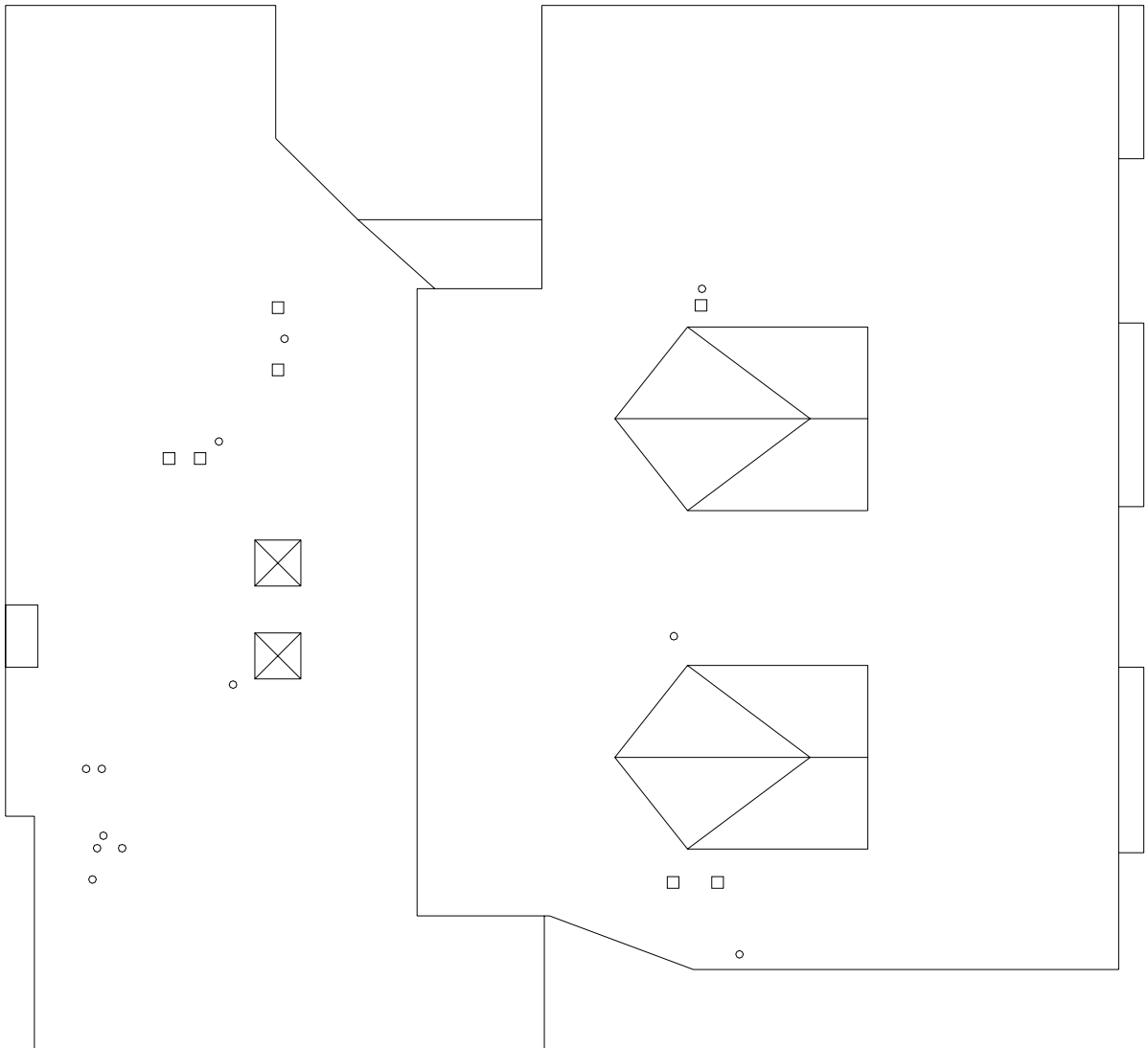

## SYMBOLS KEY

- ROOF CURB OR VENT
- ⊠ SKYLIGHT
- VENT STACK
- ⊗ LEAK LOCATION
- Ⓜ DEFECT-REPAIR

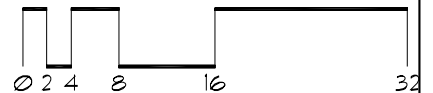

# Roof ID

Building: 151 - Como Student Housing - ()

Total Area: 156,700 sf

<u>1</u>	<u>15,100 sf</u>	<u>13</u>	<u>10,200 sf</u>	<u>6</u>	<u>15,100 sf</u>
<u>10</u>	<u>10,200 sf</u>	<u>2</u>	<u>15,100 sf</u>	<u>7</u>	<u>15,100 sf</u>
<u>11</u>	<u>15,100 sf</u>	<u>4</u>	<u>10,200 sf</u>	<u>8</u>	<u>15,100 sf</u>
<u>12</u>	<u>10,200 sf</u>	<u>5</u>	<u>15,100 sf</u>	<u>9</u>	<u>10,200 sf</u>

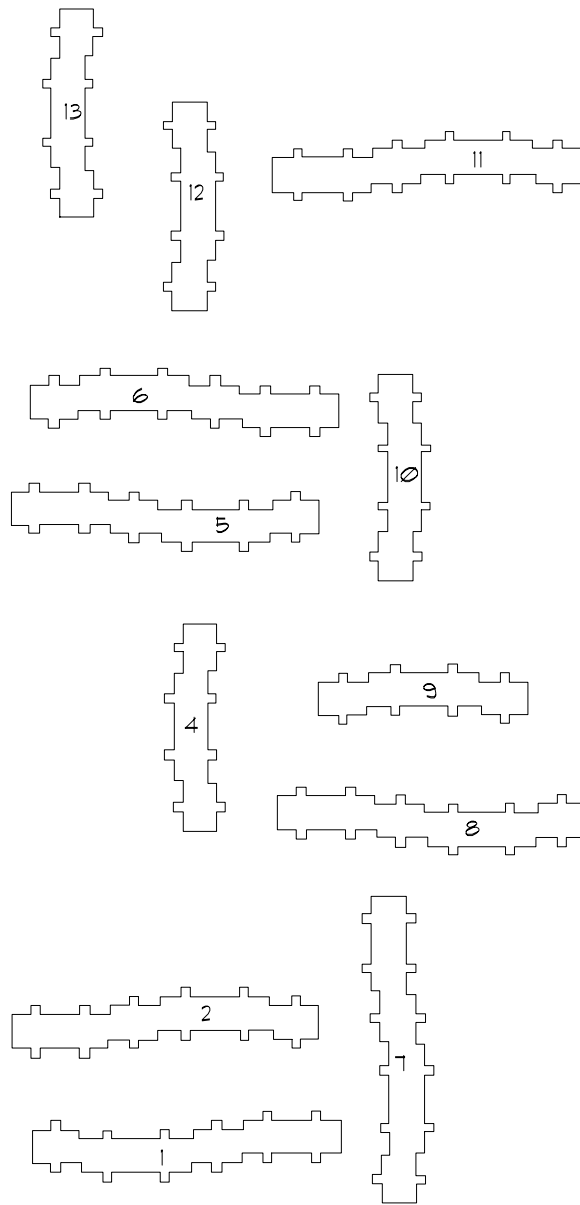

SYMBOLS KEY



# Roof Corrective Action

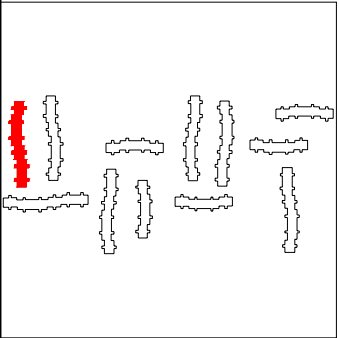
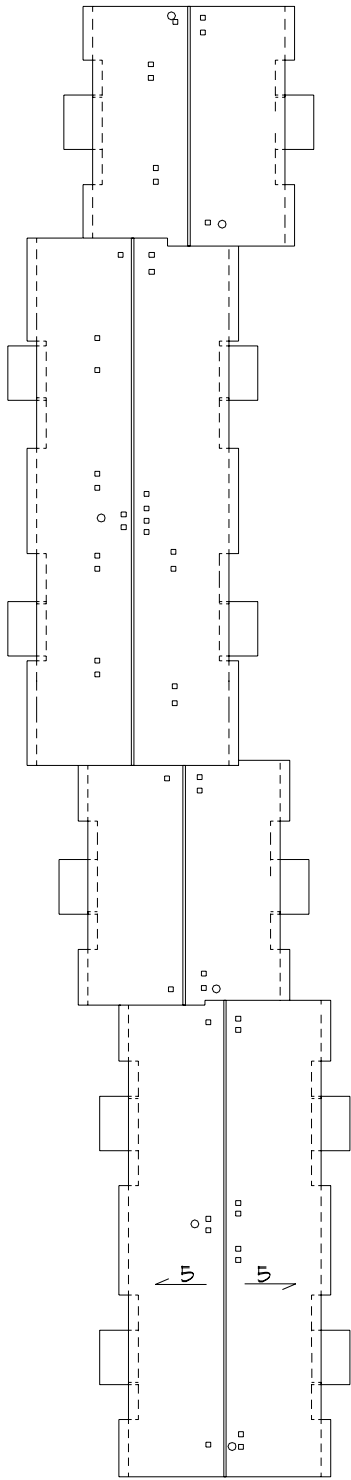

## SYMBOLS KEY

- ROOF CURB OR VENT
- VENT STACK
- SLOPE DIRECTION
- ⊖ DEFECT-REPAIR
- ⊕ DEFECT-NO REPAIR

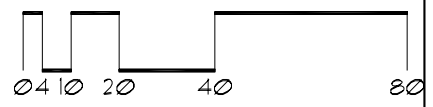

# Roof Corrective Action

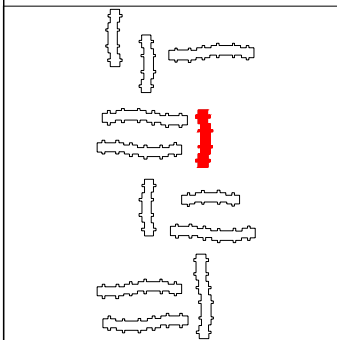
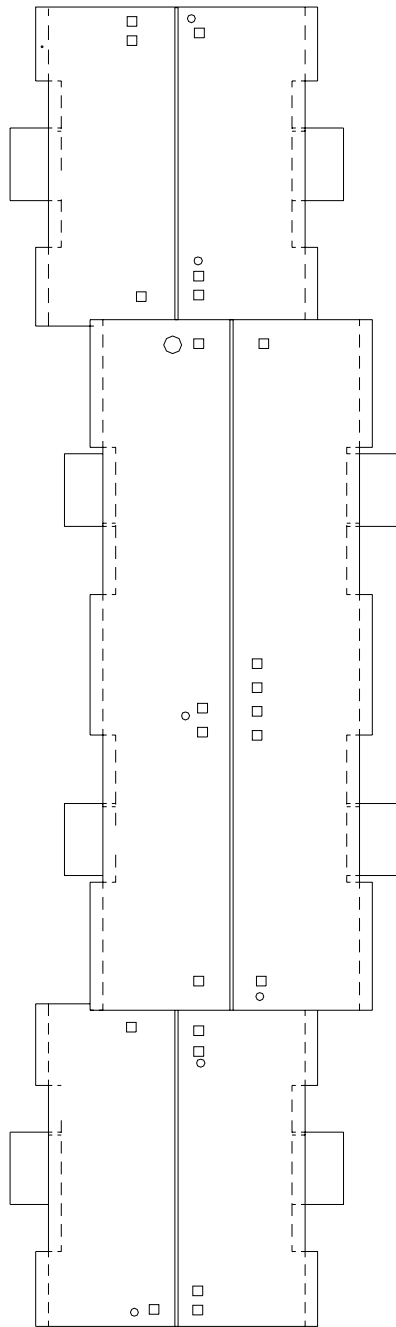

## SYMBOLS KEY

- ROOF CURB OR VENT
- VENT STACK
- Ⓢ DEFECT-REPAIR
- Ⓣ DEFECT-NO REPAIR

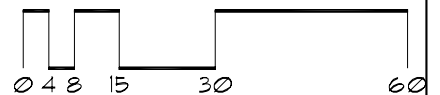

# Roof Corrective Action

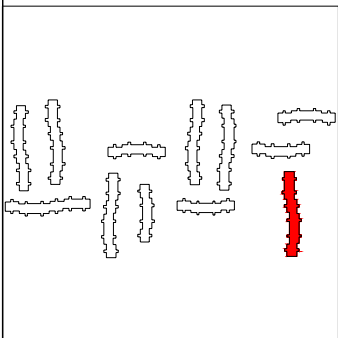
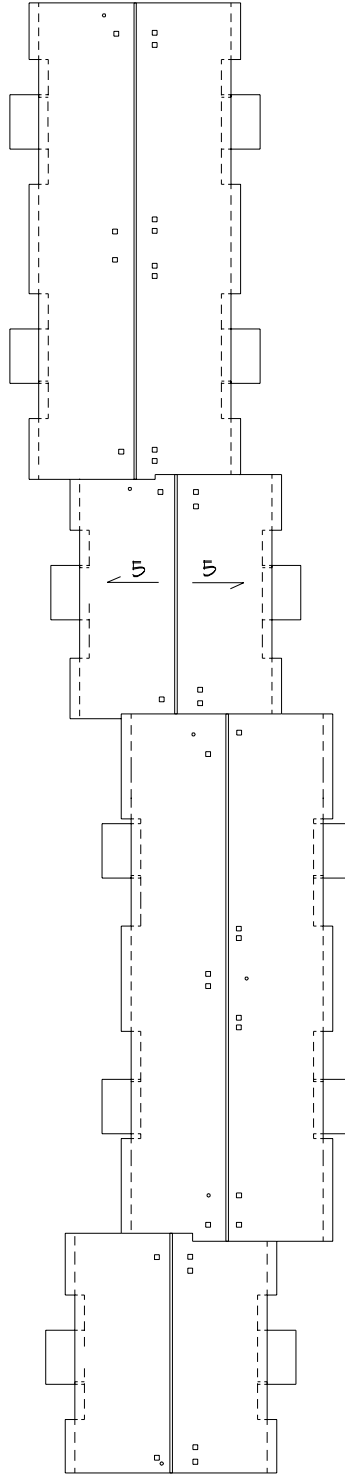

## SYMBOLS KEY

- ROOF CURB OR VENT
- VENT STACK
- SLOPE DIRECTION
- Ⓢ DEFECT-REPAIR

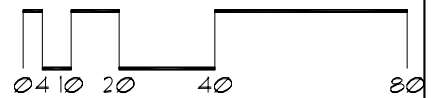
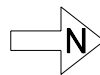



# Roof Corrective Action

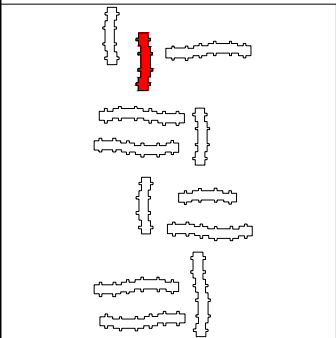
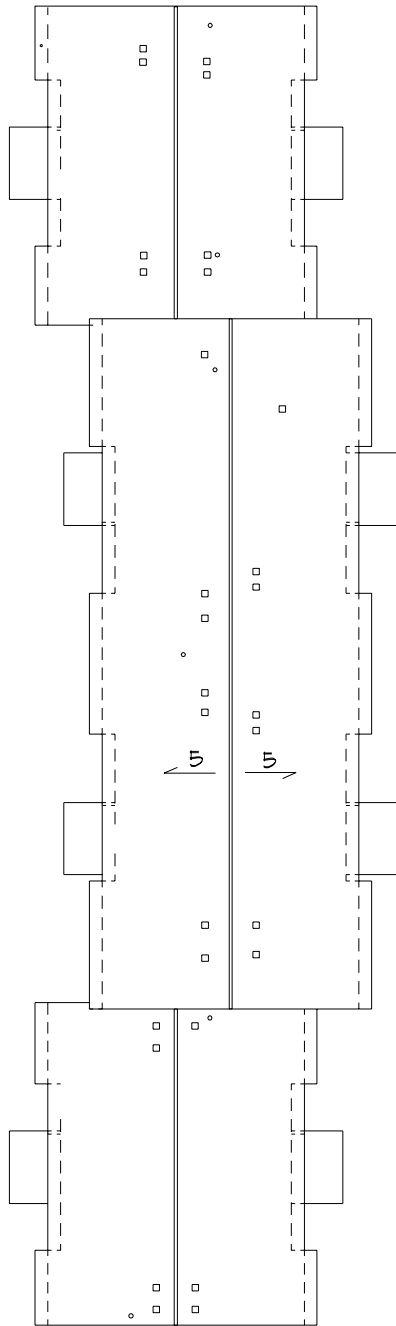

### SYMBOLS KEY

- ROOF CURB OR VENT
- VENT STACK
- ↗ SLOPE DIRECTION
- Ⓢ DEFECT-REPAIR
- Ⓣ DEFECT-NO REPAIR

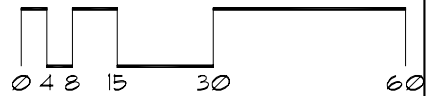

# Roof Corrective Action

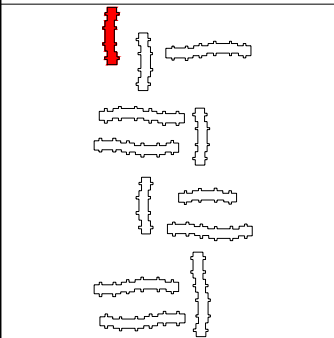
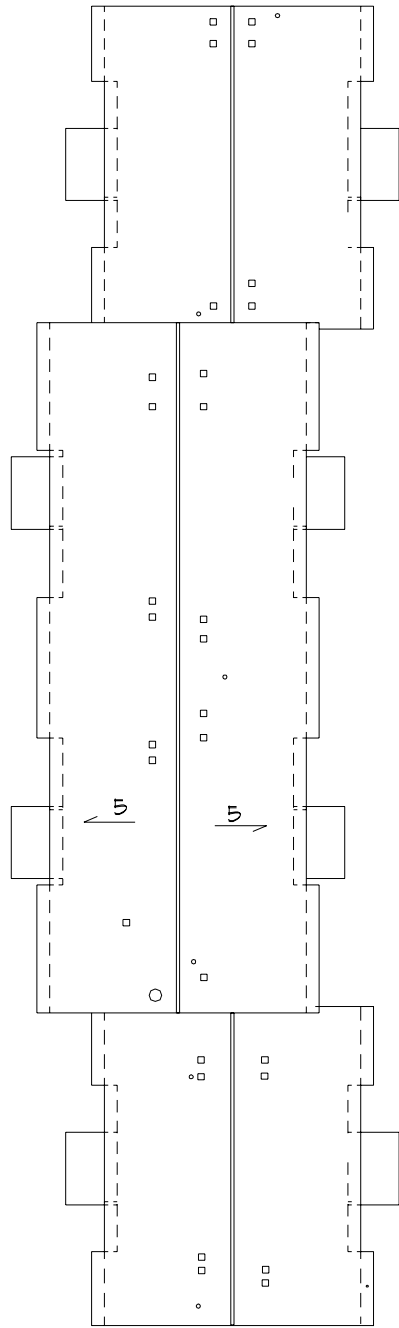

## SYMBOLS KEY

- ROOF CURB OR VENT
- VENT STACK
- SLOPE DIRECTION
- Ⓢ DEFECT-REPAIR

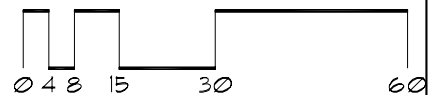

# Roof Corrective Action

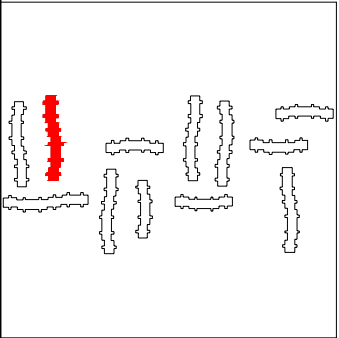
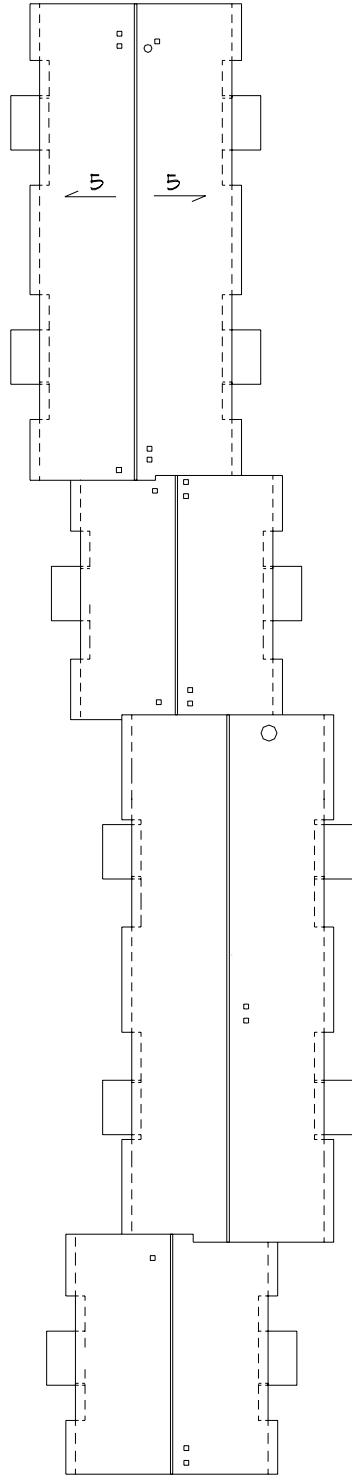

## SYMBOLS KEY

- ROOF CURB OR VENT
- VENT STACK
- ↗ SLOPE DIRECTION
- Ⓡ DEFECT-REPAIR
- Ⓢ DEFECT-NO REPAIR

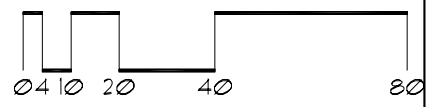

# Roof Corrective Action

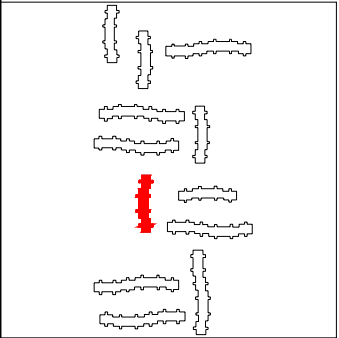
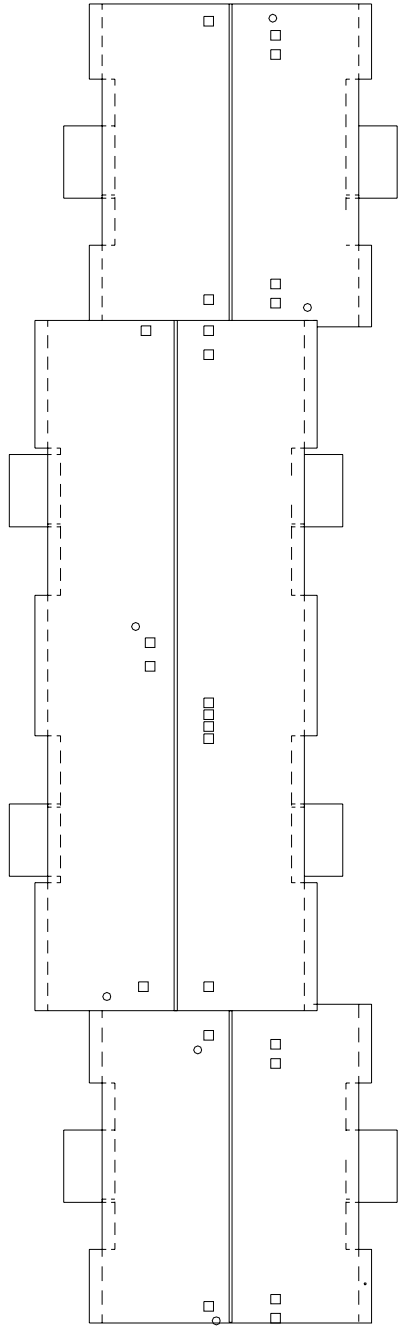

- SYMBOLS KEY**
- ROOF CURB OR VENT
  - VENT STACK
  - Ⓢ DEFECT-REPAIR
  - Ⓣ DEFECT-NO REPAIR

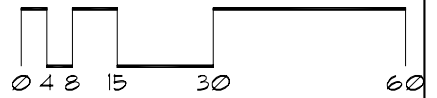

# Roof Corrective Action

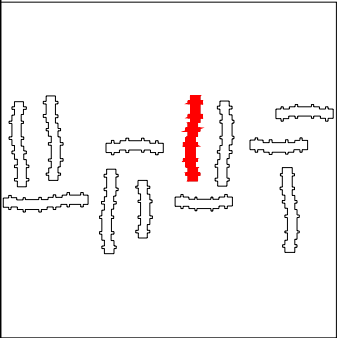
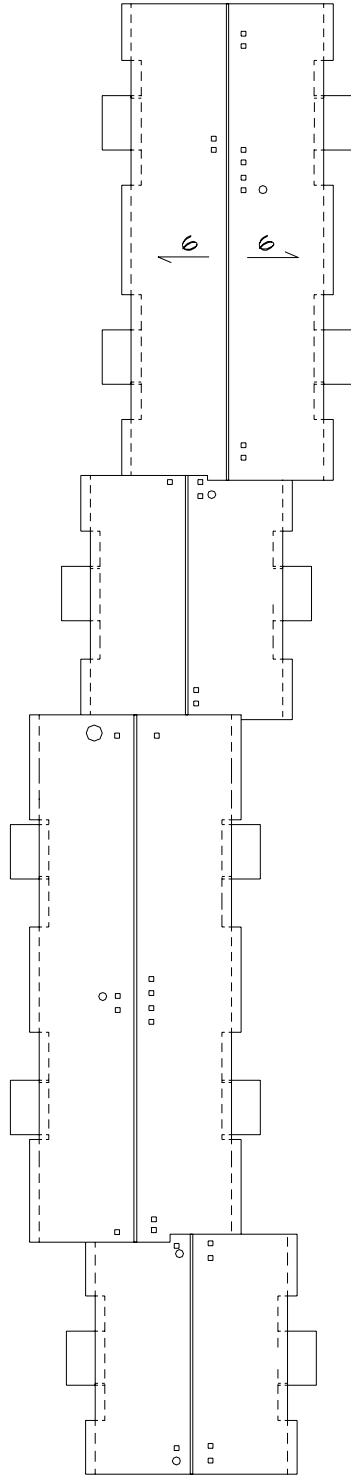

## SYMBOLS KEY

- ROOF CURB OR VENT
- VENT STACK
- SLOPE DIRECTION
- Ⓢ DEFECT-REPAIR

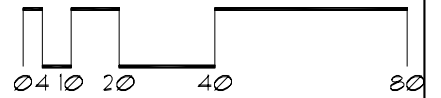

# Roof Corrective Action

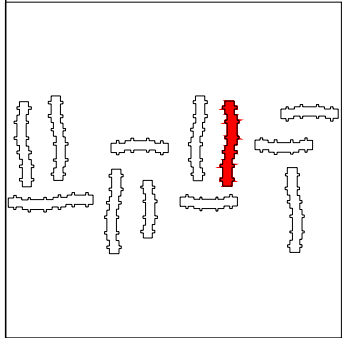
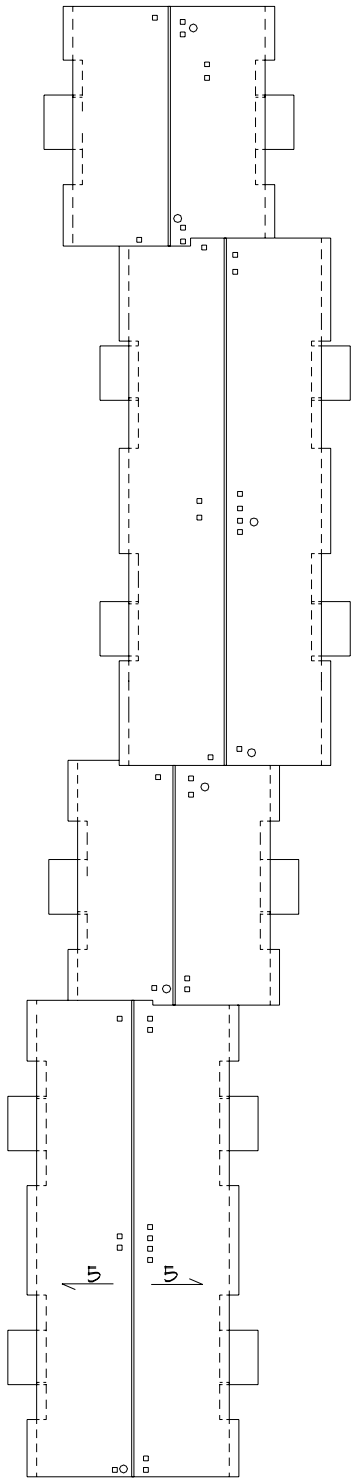

- SYMBOLS KEY**
- ROOF CURB OR VENT
  - VENT STACK
  - ↗ SLOPE DIRECTION
  - ① DEFECT-REPAIR

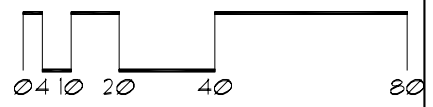
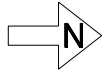

# Roof Corrective Action

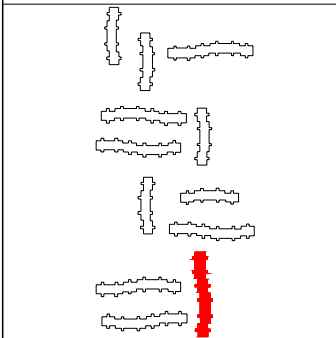
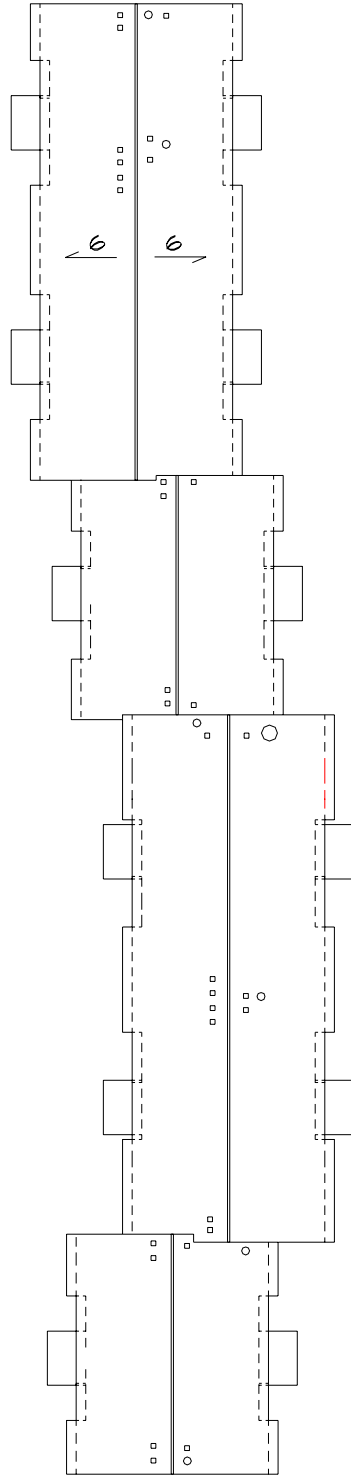

## SYMBOLS KEY

- ROOF CURB OR VENT
- VENT STACK
- SLOPE DIRECTION
- ⊙ DEFECT-REPAIR
- ⓪ DEFECT-NO REPAIR

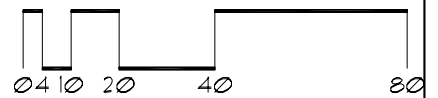

# Roof Corrective Action

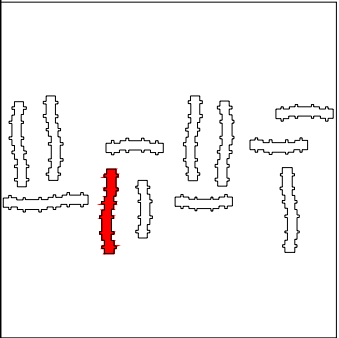
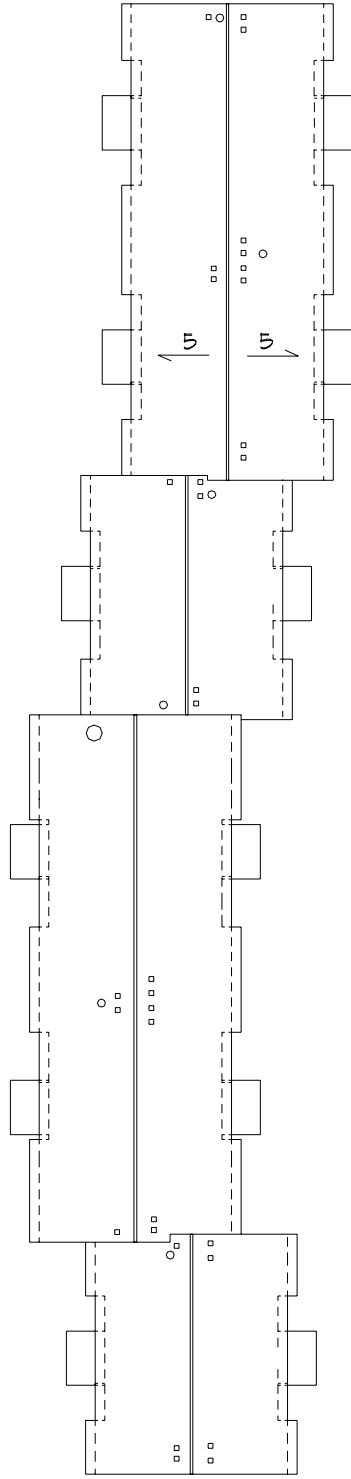

## SYMBOLS KEY

- ROOF CURB OR VENT
- VENT STACK
- SLOPE DIRECTION
- Ⓣ DEFECT-REPAIR

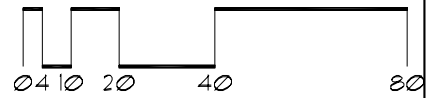



# Roof Corrective Action

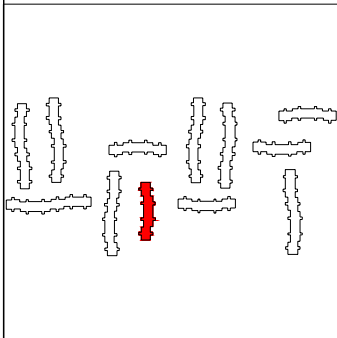
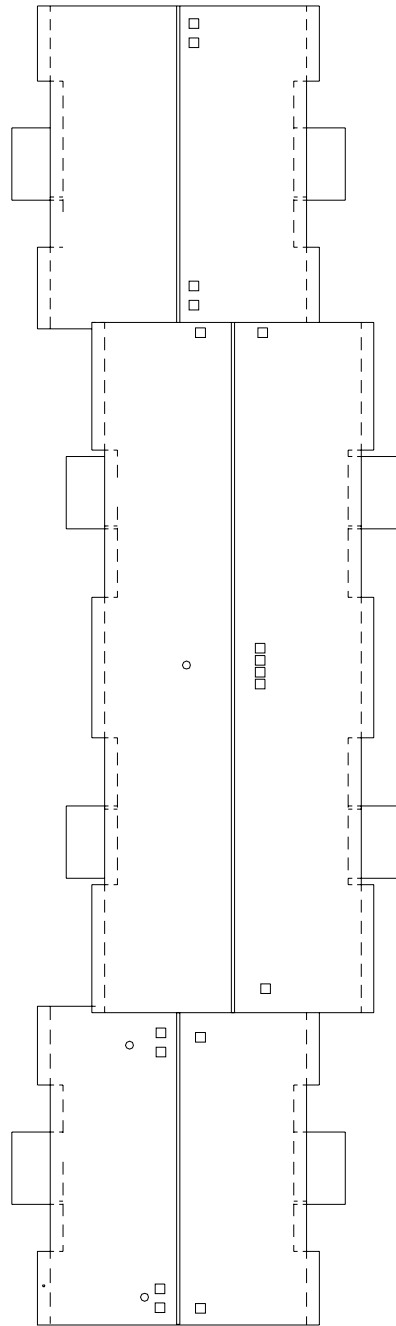

## SYMBOLS KEY

- ROOF CURB OR VENT
- VENT STACK
- Ⓢ DEFECT-REPAIR
- Ⓣ DEFECT-NO REPAIR

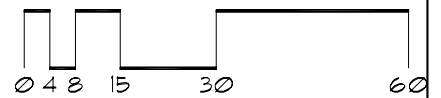

# Roof ID

Building: 063 - Comstock Hall - (210 Delaware St SE)

Total Area: 23,736 sf

<u>A</u>	<u>720</u> sf	<u>E</u>	<u>2,354</u> sf	<u>I</u>	<u>482</u> sf	<u>M</u>	<u>220</u> sf	<u>Q</u>	<u>3,268</u> sf
<u>B</u>	<u>3,288</u> sf	<u>F</u>	<u>2,250</u> sf	<u>J</u>	<u>480</u> sf	<u>N</u>	<u>3,476</u> sf	<u>R</u>	<u>240</u> sf
<u>C</u>	<u>204</u> sf	<u>G</u>	<u>450</u> sf	<u>K</u>	<u>1,677</u> sf	<u>O</u>	<u>2,577</u> sf		
<u>D</u>	<u>446</u> sf	<u>H</u>	<u>81</u> sf	<u>L</u>	<u>1,353</u> sf	<u>P</u>	<u>170</u> sf		

SYMBOLS KEY

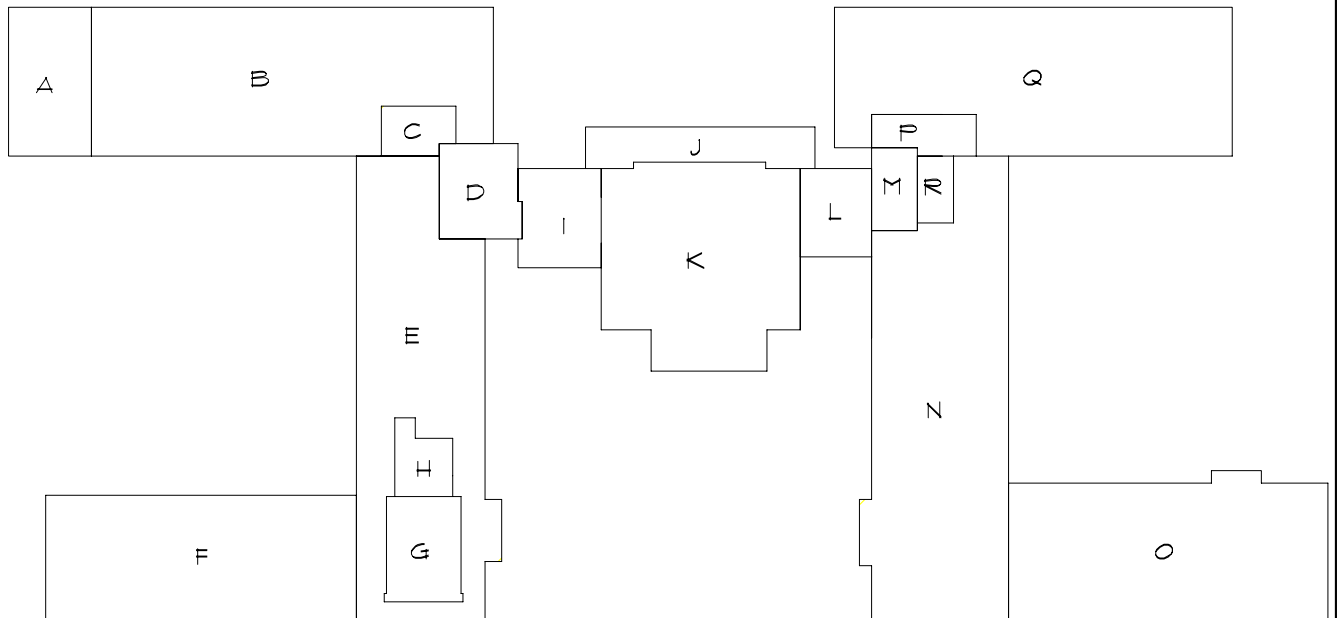

# Roof Corrective Action

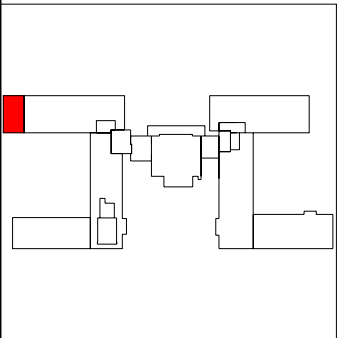
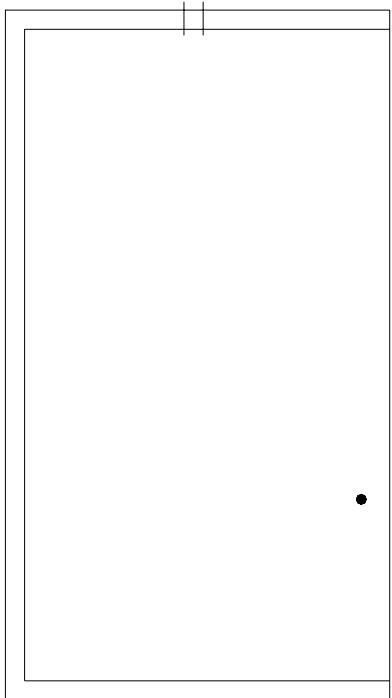

### SYMBOLS KEY

- ROOF DRAIN
- Ⓢ DEFECT-REPAIR
- ++ SCUPPER

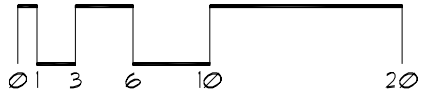

# Roof Corrective Action

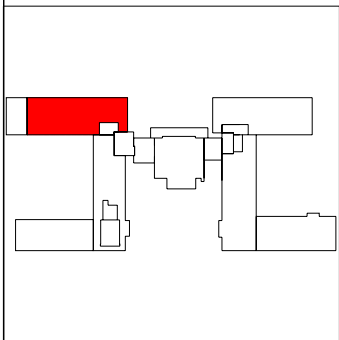
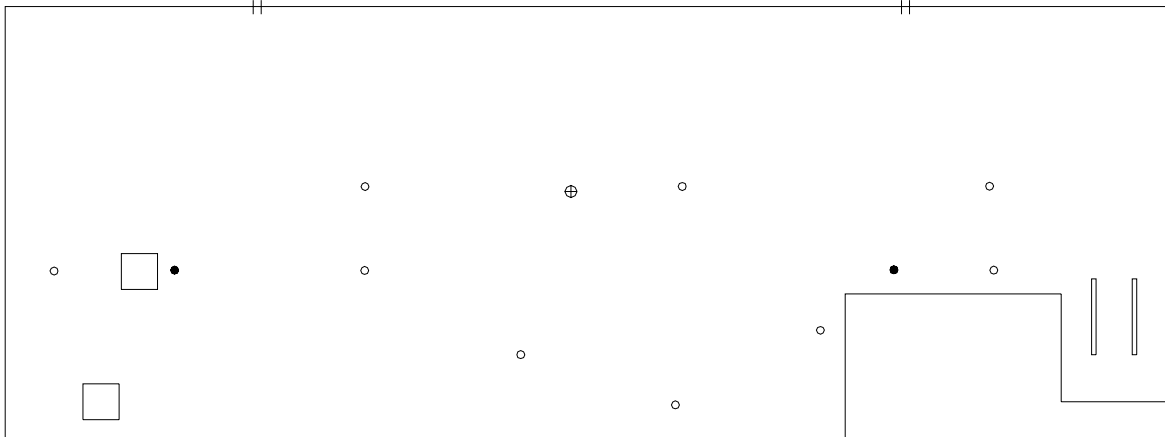

## SYMBOLS KEY

- ROOF CURB
- ROOF DRAIN
- VENT STACK
- ⊕ SCUPPER
- ⊕ FLASHED PEN.

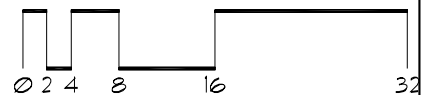

# Roof Corrective Action

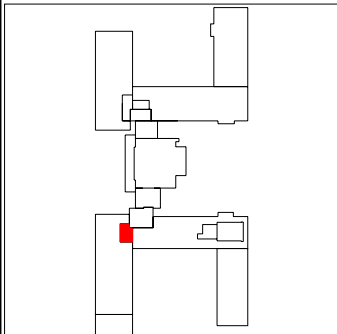
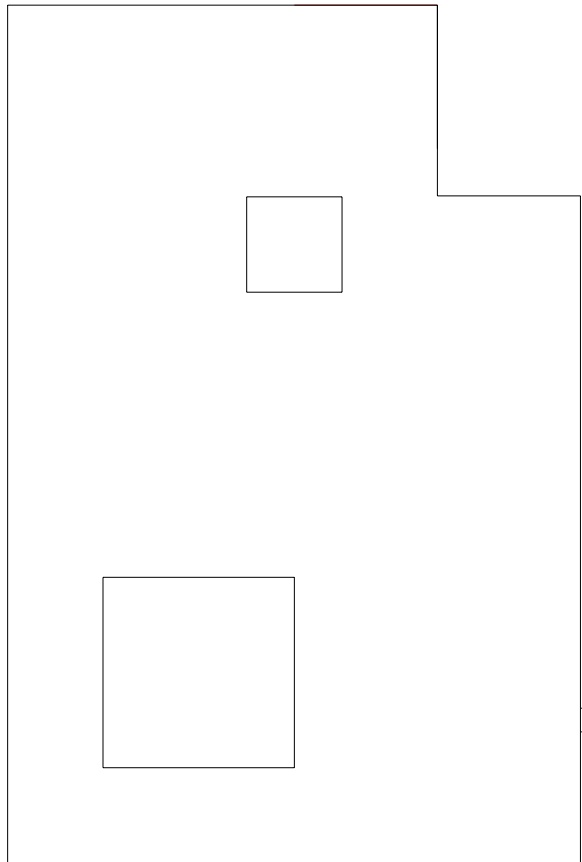

SYMBOLS KEY  
□ ROOF CURB  
I LADDER

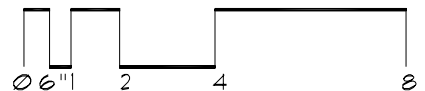

# Roof Corrective Action

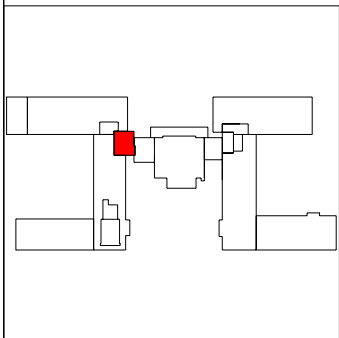
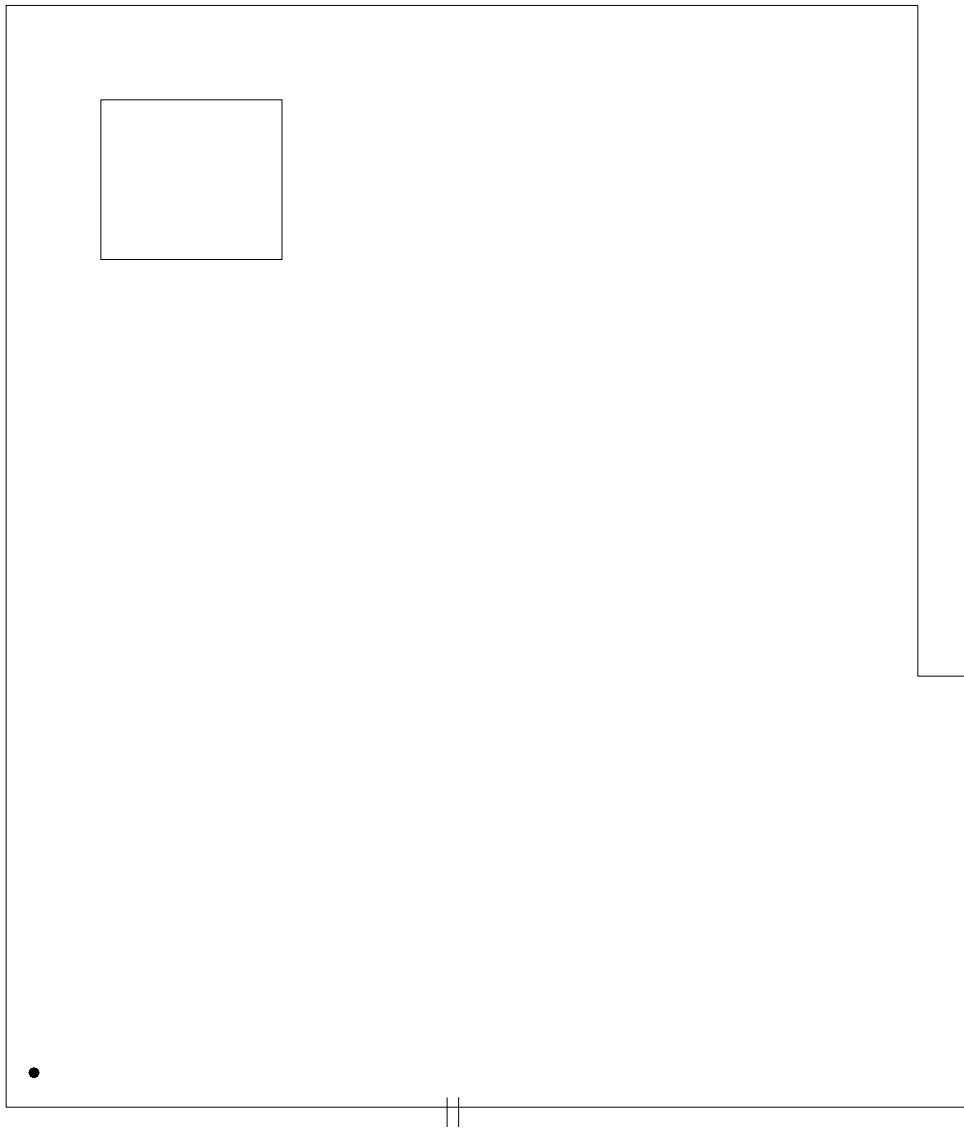

- SYMBOLS KEY
- ROOF DRAIN
  - ≡ SCUPPER
  - ROOF CURB OR VENT

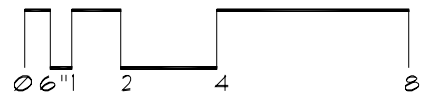

# Roof Corrective Action

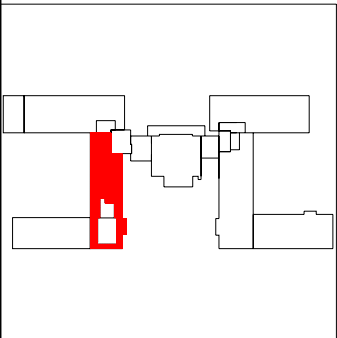
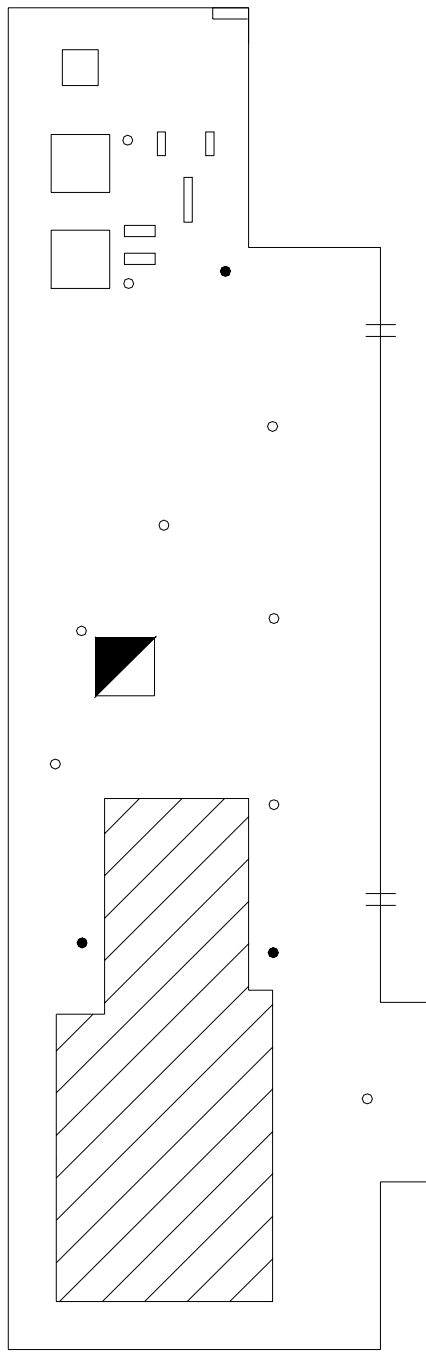

## SYMBOLS KEY

- ROOF CURB
- ROOF DRAIN
- VENT STACK
- ≡ SCUPPER
- ⊖ DEFECT-REPAIR
- ▣ CHIMNEY

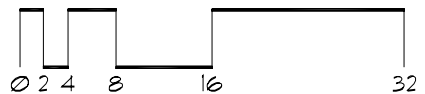

# Roof Corrective Action

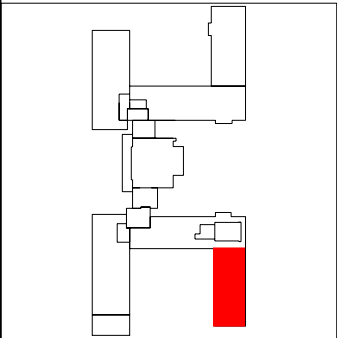
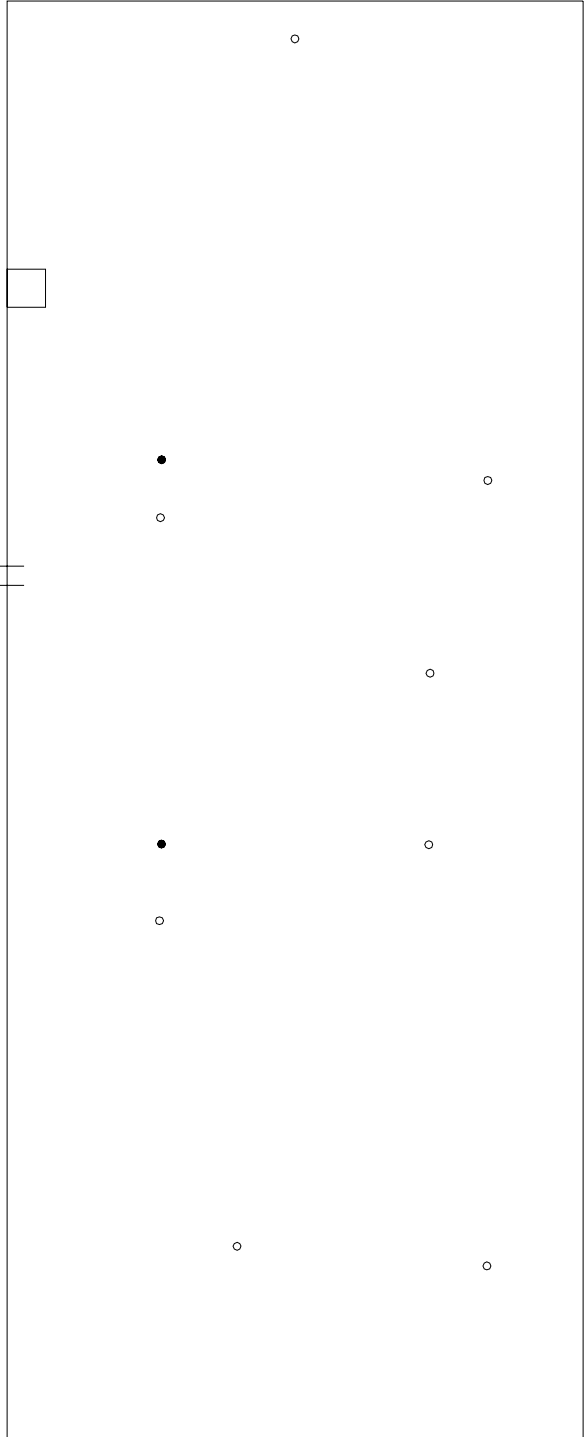

## SYMBOLS KEY

- ROOF CURB
- ROOF DRAIN
- VENT STACK
- || SCUPPER

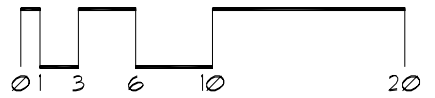



# Roof Corrective Action

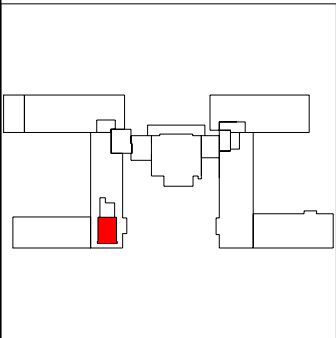
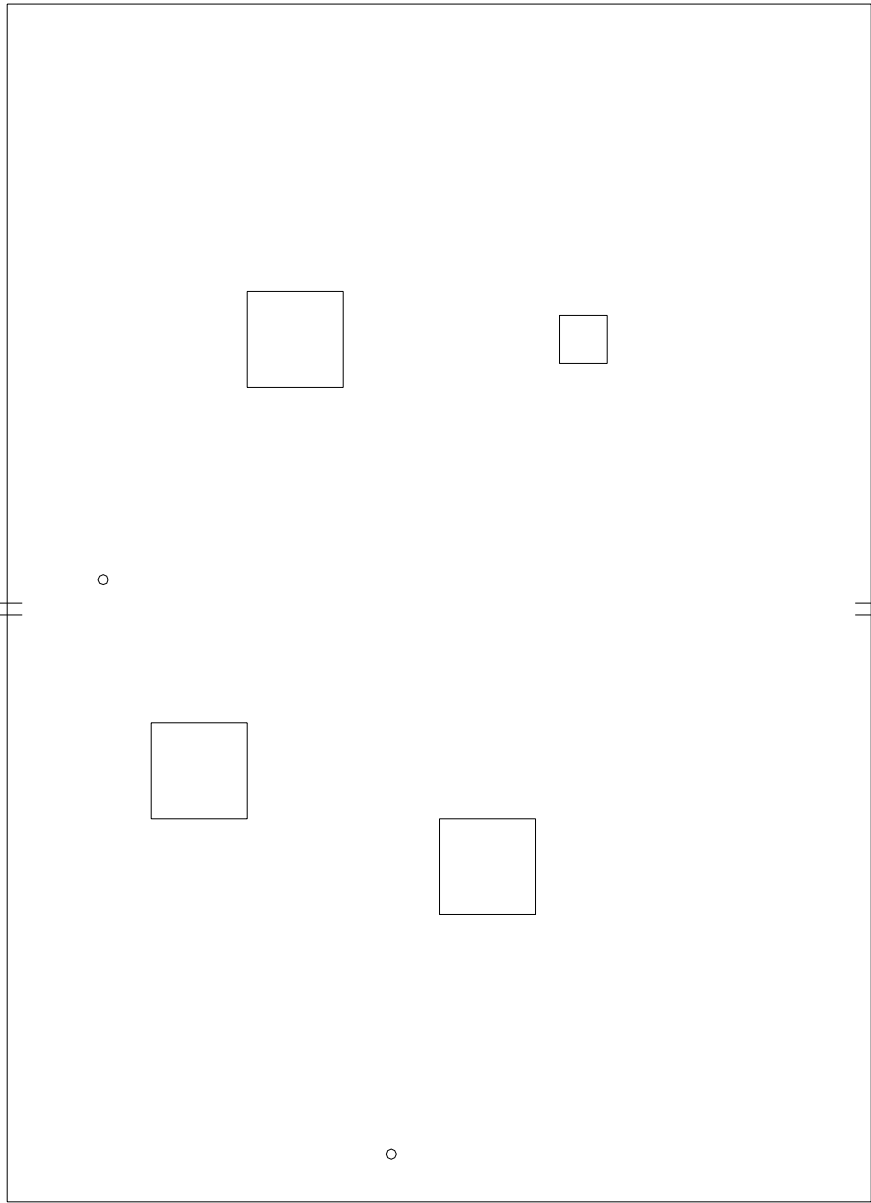

## SYMBOLS KEY

- ROOF CURB
- VENT STACK
- ≡ SCUPPER
- DEFECT-REPAIR

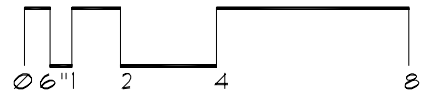

# Roof Corrective Action

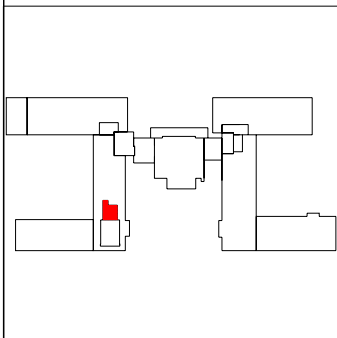
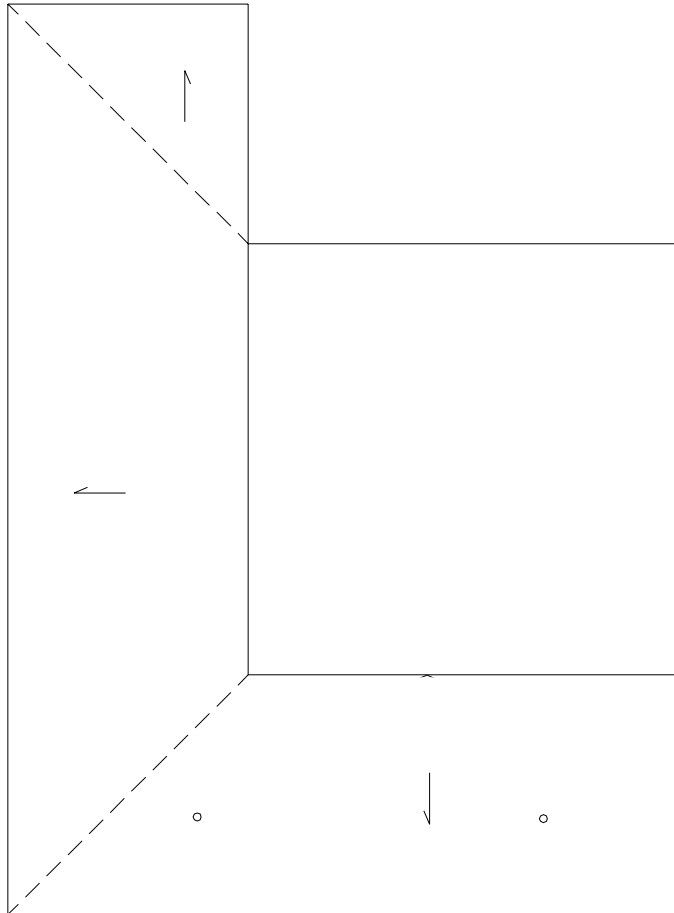

### SYMBOLS KEY

- VENT STACK
- SLOPE DIRECTION
- Ⓢ DEFECT-REPAIR
- ⓪ DEFECT-NO REPAIR

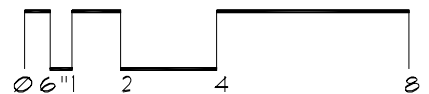

# Roof Corrective Action

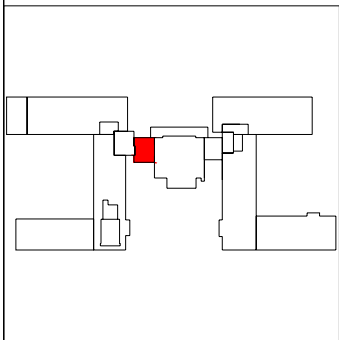
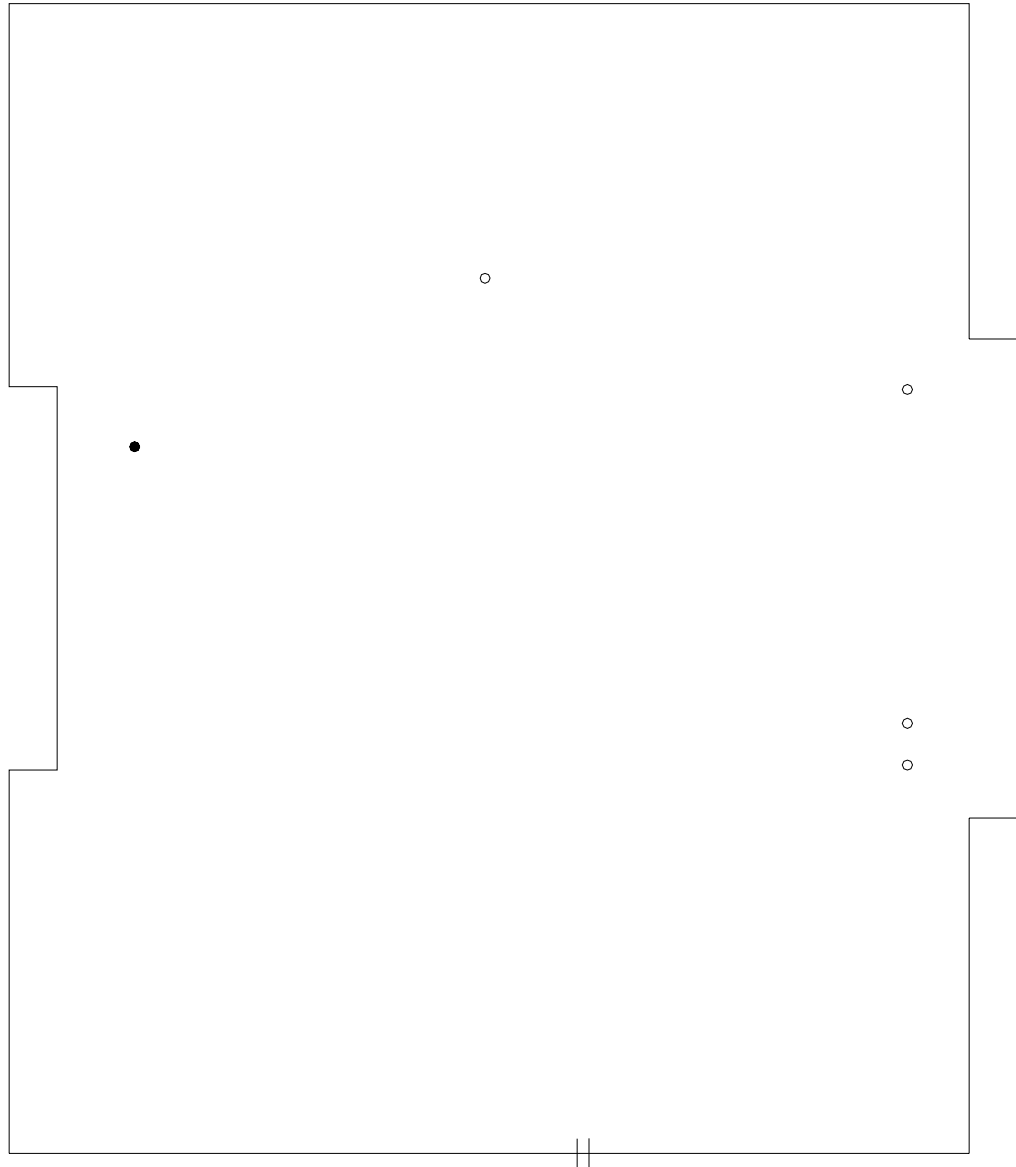

**SYMBOLS KEY**

	SCUPPER
●	ROOF DRAIN
○	VENT STACK

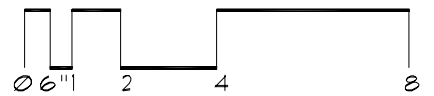

# Roof Corrective Action

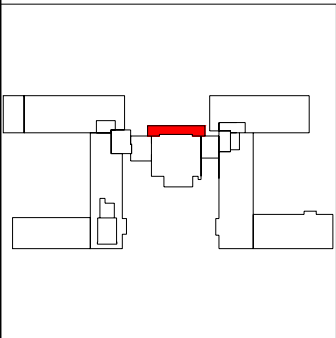

SYMBOLS KEY  
• ROOF DRAIN

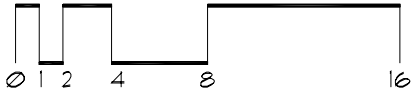

# Roof Corrective Action

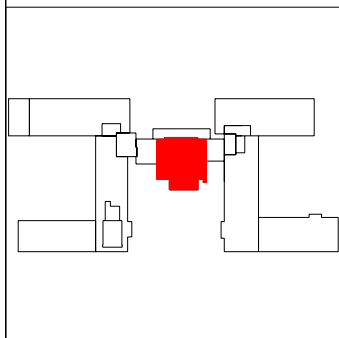
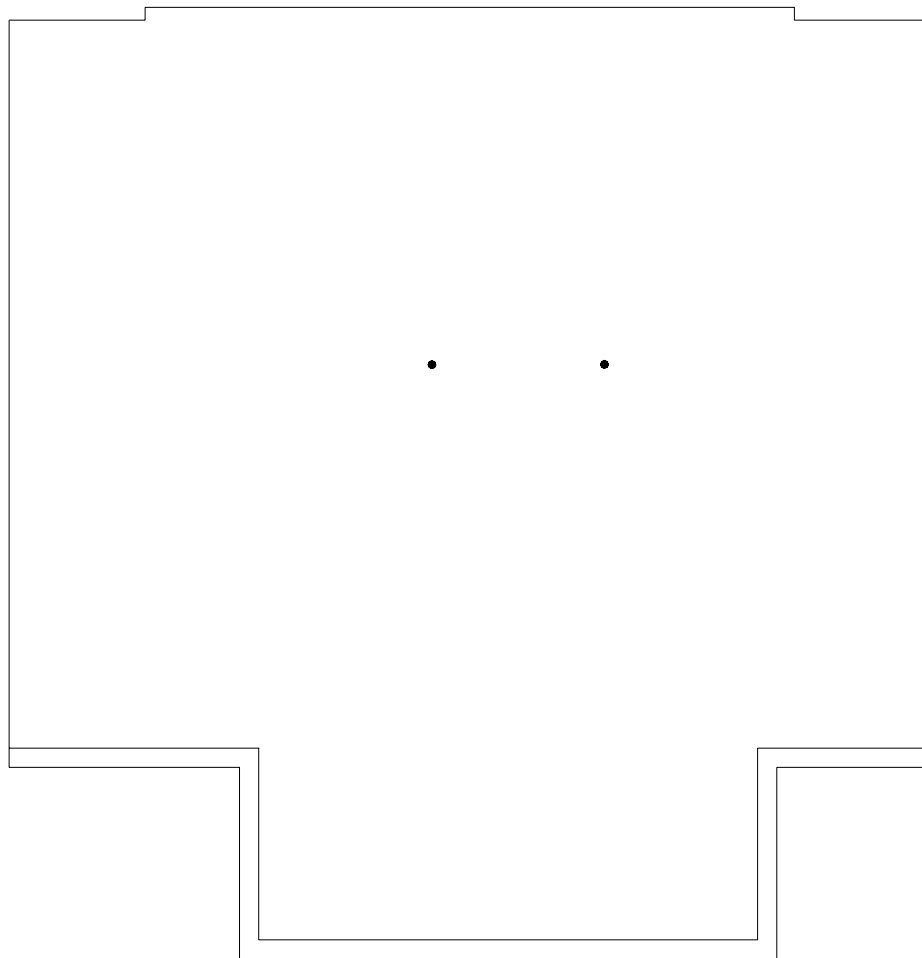

SYMBOLS KEY  
• ROOF DRAIN

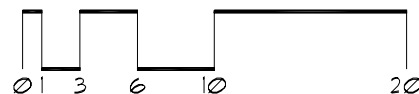

# Roof Corrective Action

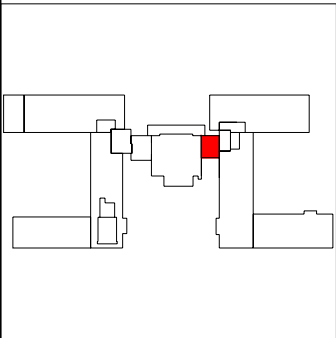
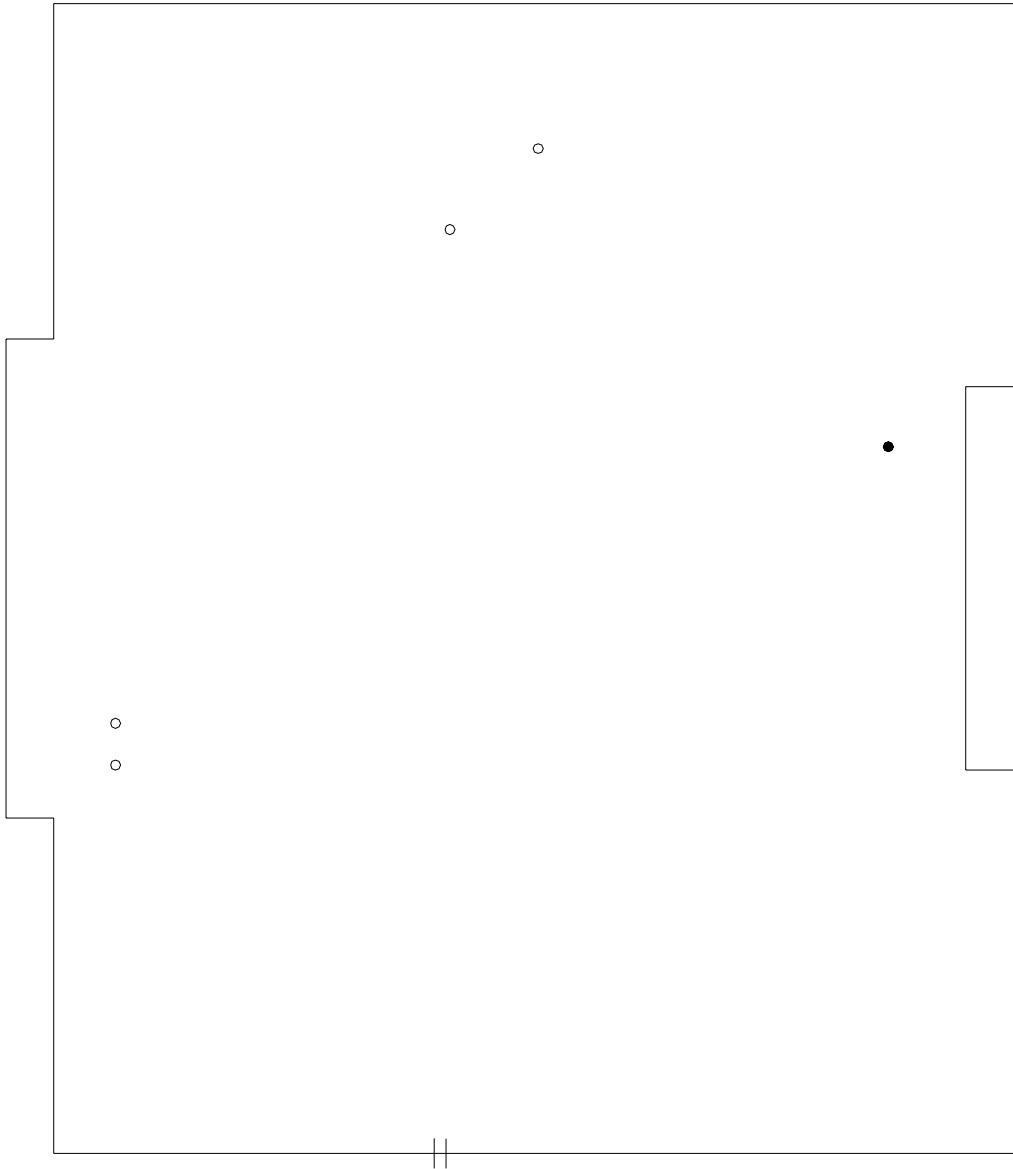

SYMBOLS KEY	
	SCUPPER
●	ROOF DRAIN
○	VENT STACK

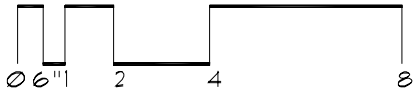

# Roof Corrective Action

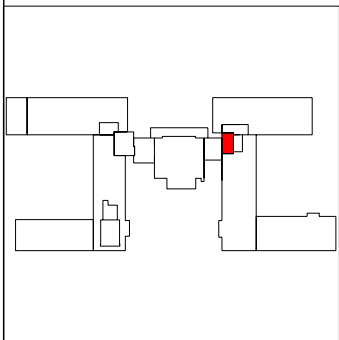
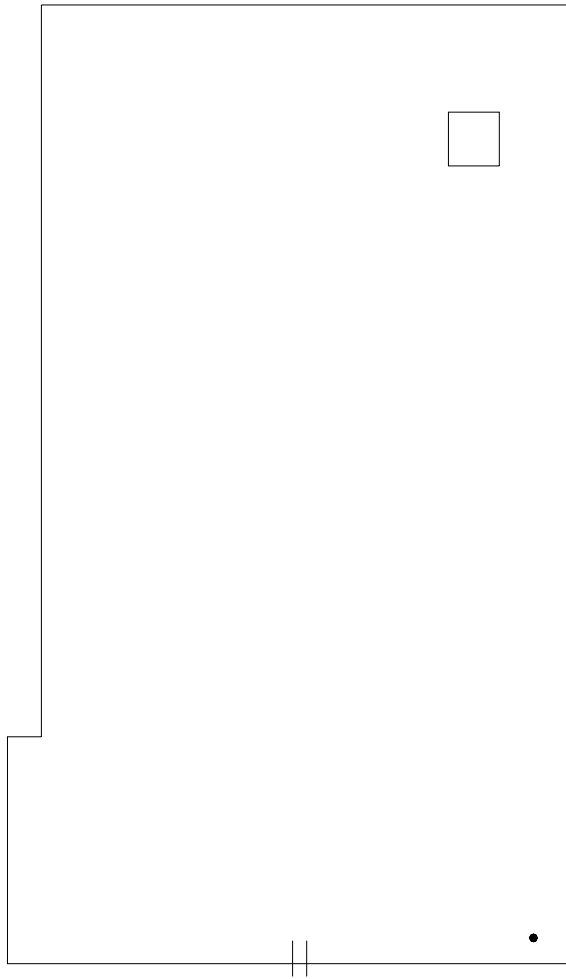

- SYMBOLS KEY
- ROOF CURB
  - ROOF DRAIN
  - || SCUPPER

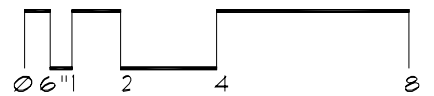

# Roof Corrective Action

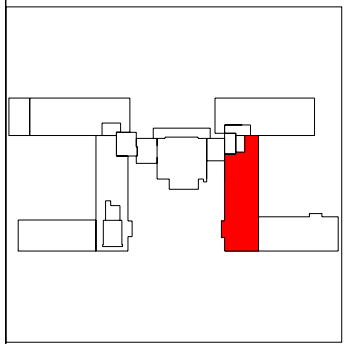
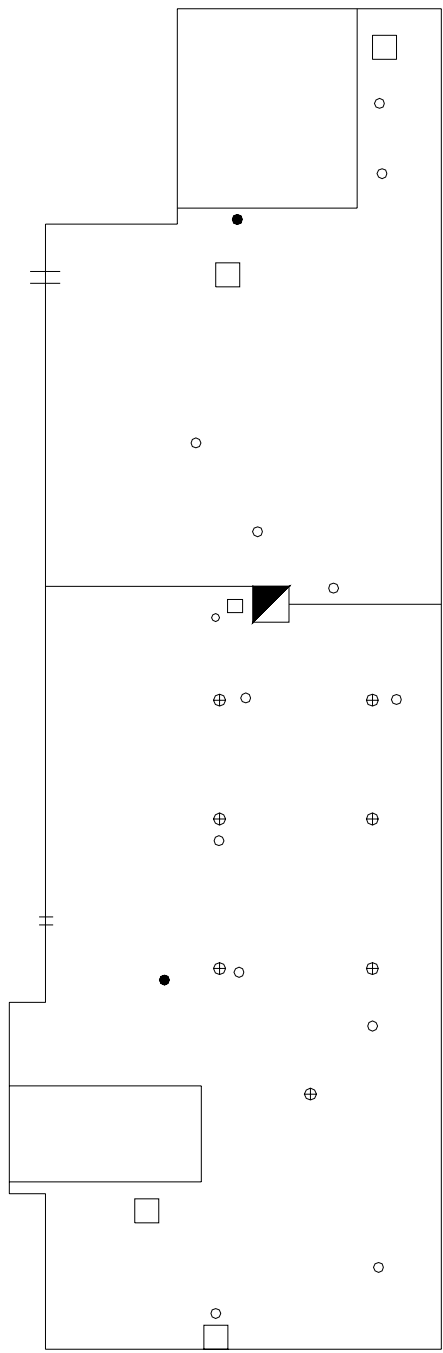

**SYMBOLS KEY**

- ROOF CURB
- ROOF DRAIN
- VENT STACK
- † SCUPPER
- ▀ CHIMNEY
- ⊕ FLASHED PEN.

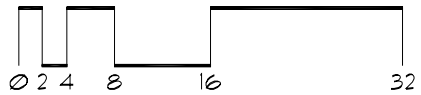



# Roof Corrective Action

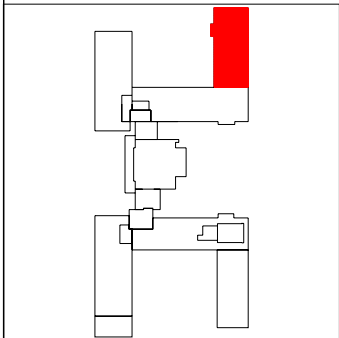
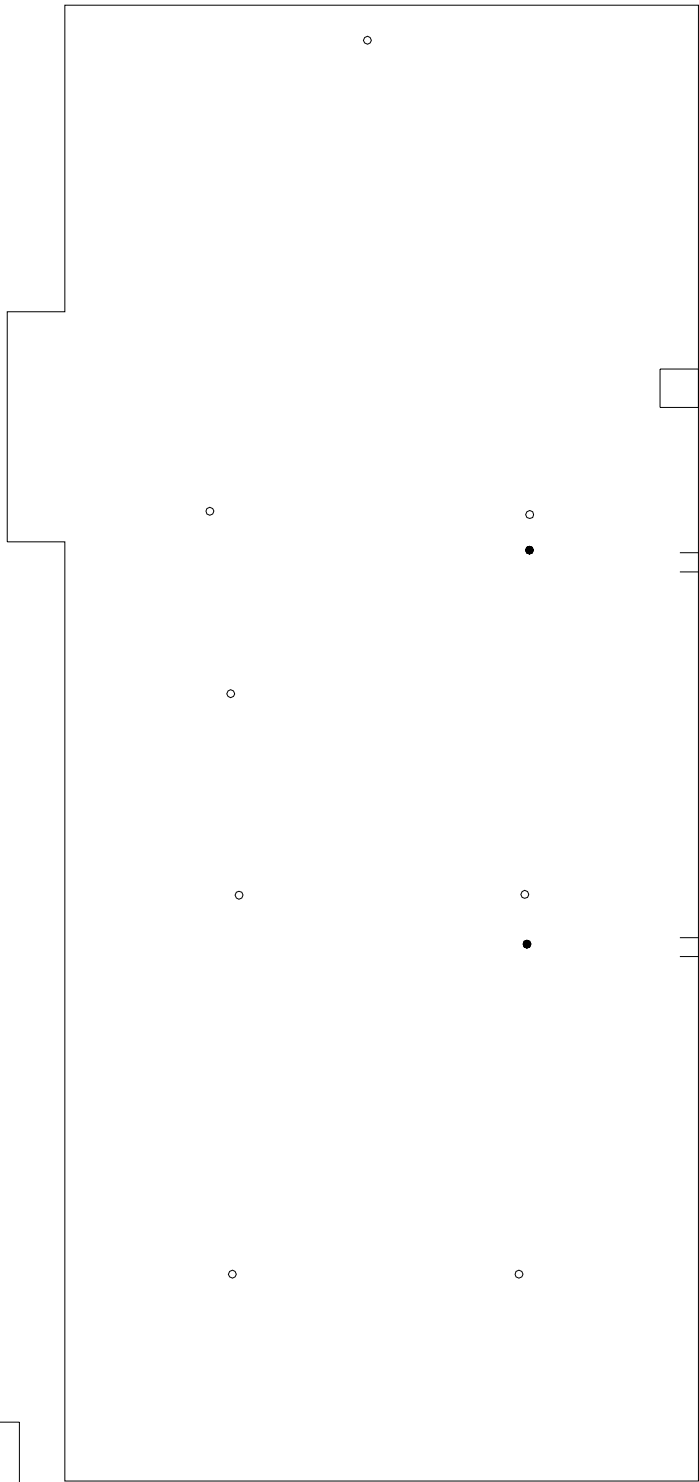

## SYMBOLS KEY

- ROOF CURB
- ROOF DRAIN
- VENT STACK
- † SCUPPER
- Ⓢ DEFECT-REPAIR
- Ⓣ DEFECT-NO REPAIR

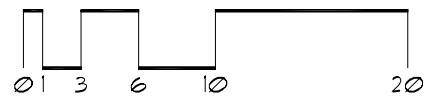

# Roof Corrective Action

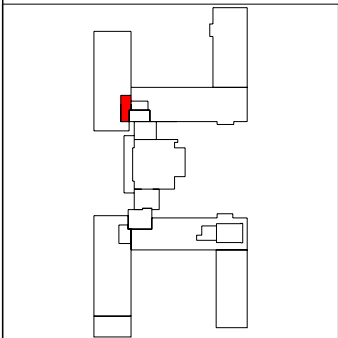
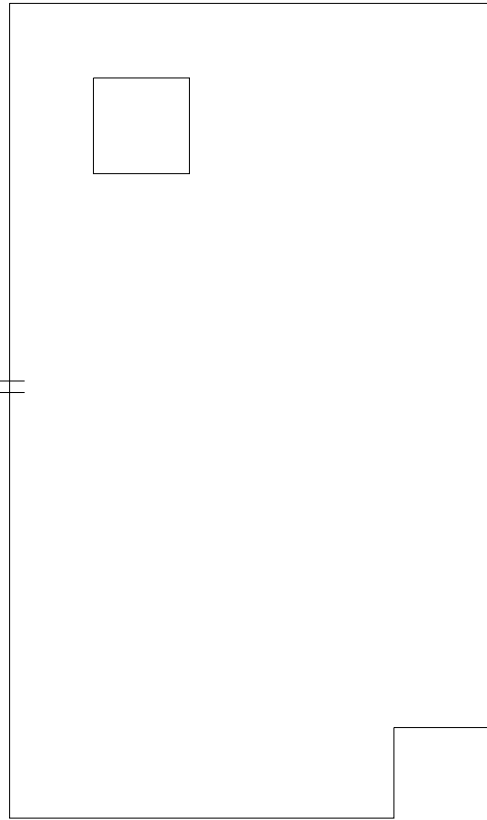

SYMBOLS KEY  
□ ROOF CURB  
⊥ SCUPPER

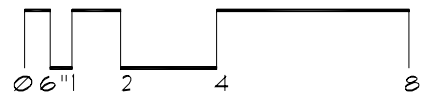

# Roof Corrective Action

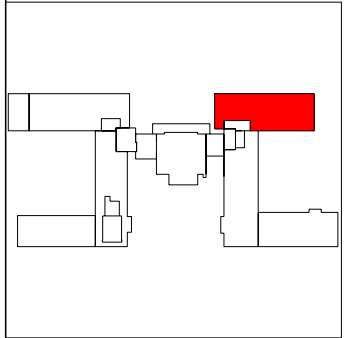
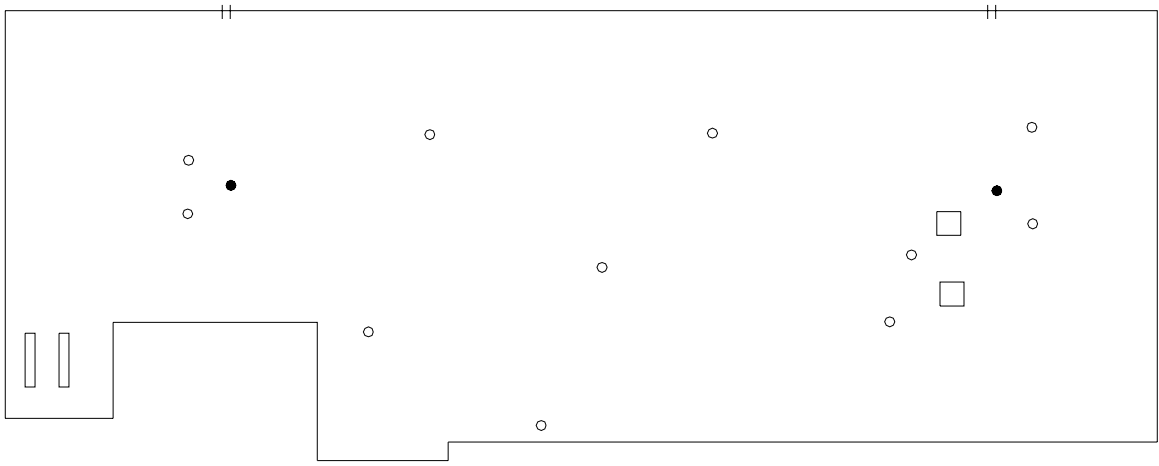

- SYMBOLS KEY
- ROOF CURB
  - ROOF DRAIN
  - VENT STACK
  - ≡ SCUPPER

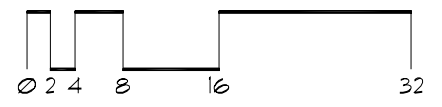

# Roof Corrective Action

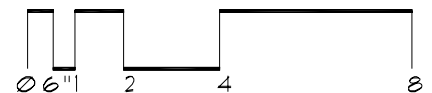
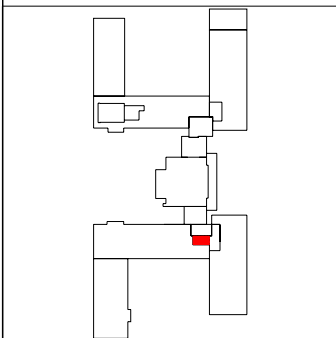
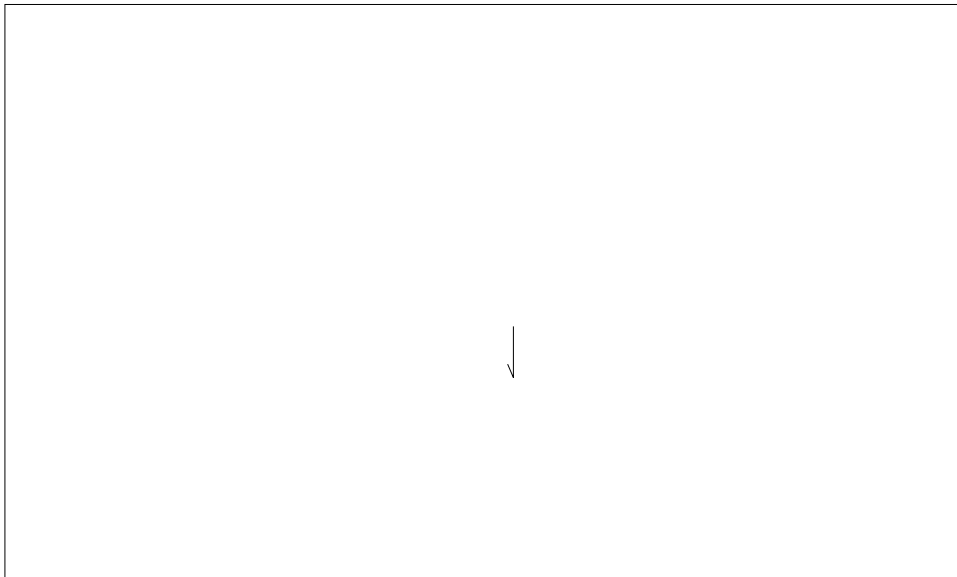

# Roof ID

Building: 110 - Frontier Hall - (701 Fulton St SE)

Total Area: 38,735 sf

<u>A</u>	<u>26,215</u> sf	<u>E</u>	<u>210</u> sf	<u>I</u>	<u>62</u> sf
<u>B</u>	<u>221</u> sf	<u>F</u>	<u>588</u> sf	<u>J</u>	<u>3,232</u> sf
<u>C</u>	<u>221</u> sf	<u>G</u>	<u>3,348</u> sf	<u>K</u>	<u>3,664</u> sf
<u>D</u>	<u>221</u> sf	<u>H</u>	<u>536</u> sf	<u>L</u>	<u>217</u> sf

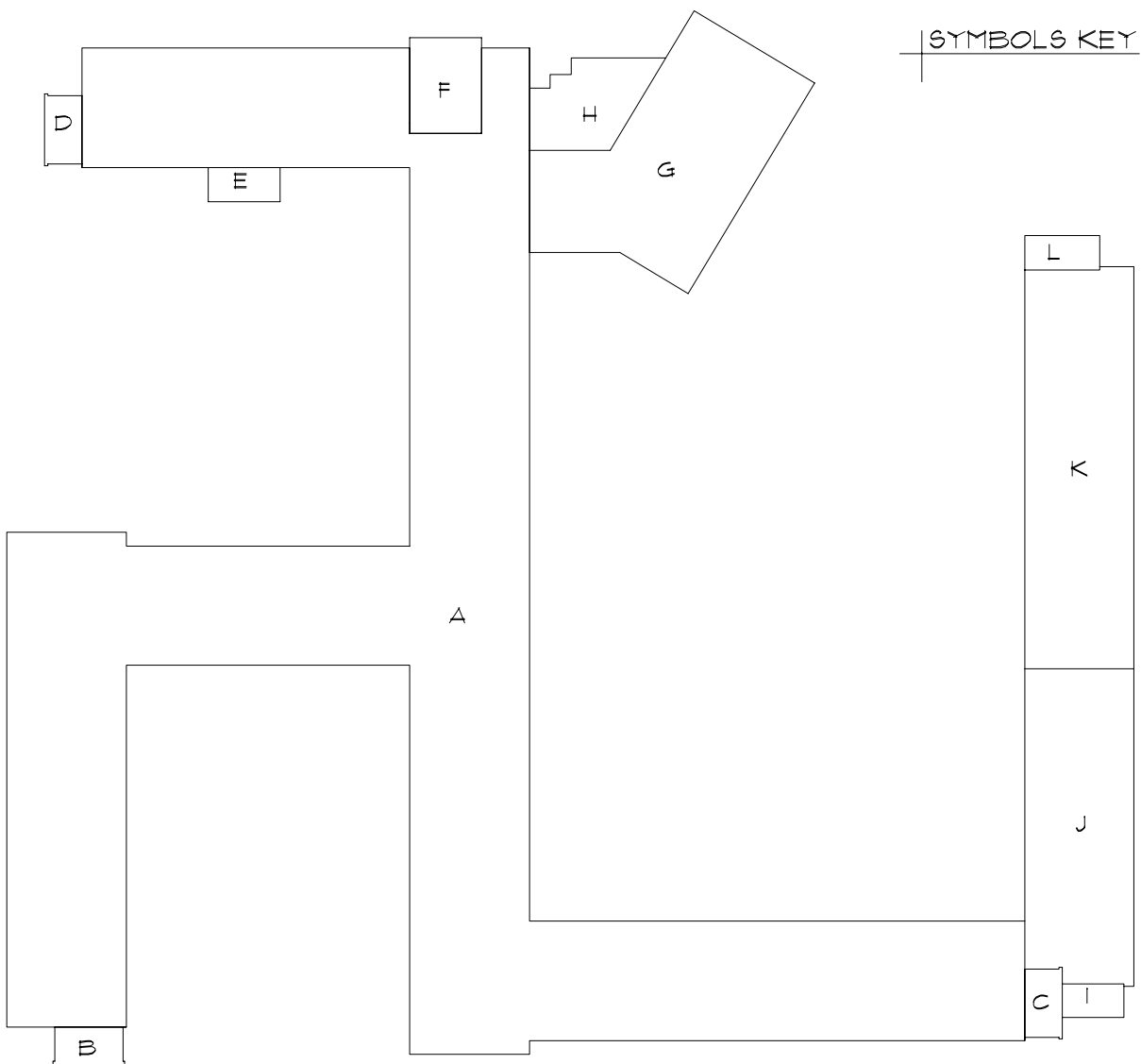

SYMBOLS KEY



# Roof Corrective Action

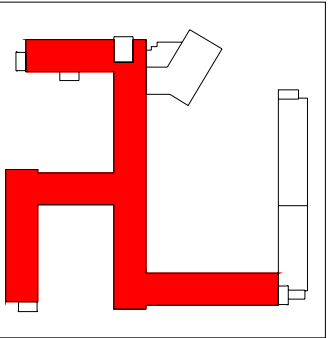

- SYMBOLS KEY**
- ROOF CURB
  - ROOF DRAIN
  - VENT STACK
  - || SCUPPER

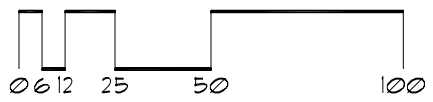

# Roof Corrective Action

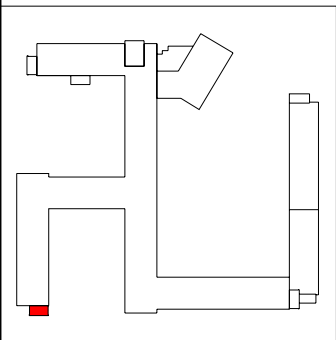
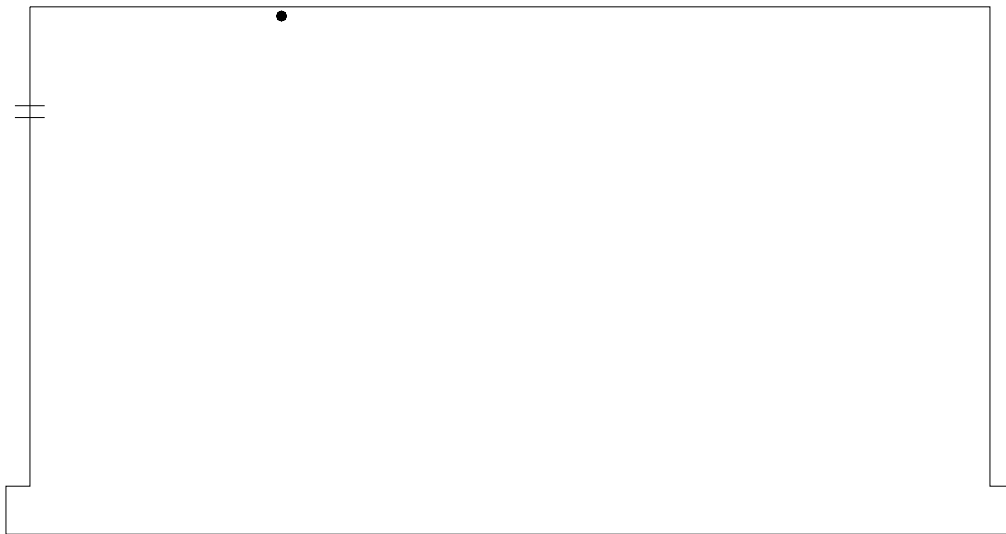

SYMBOLS KEY  
|| SCUPPER  
• ROOF DRAIN

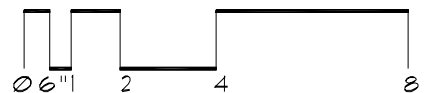

# Roof Corrective Action

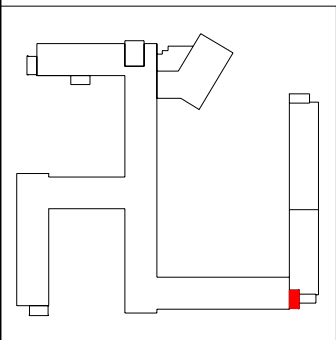
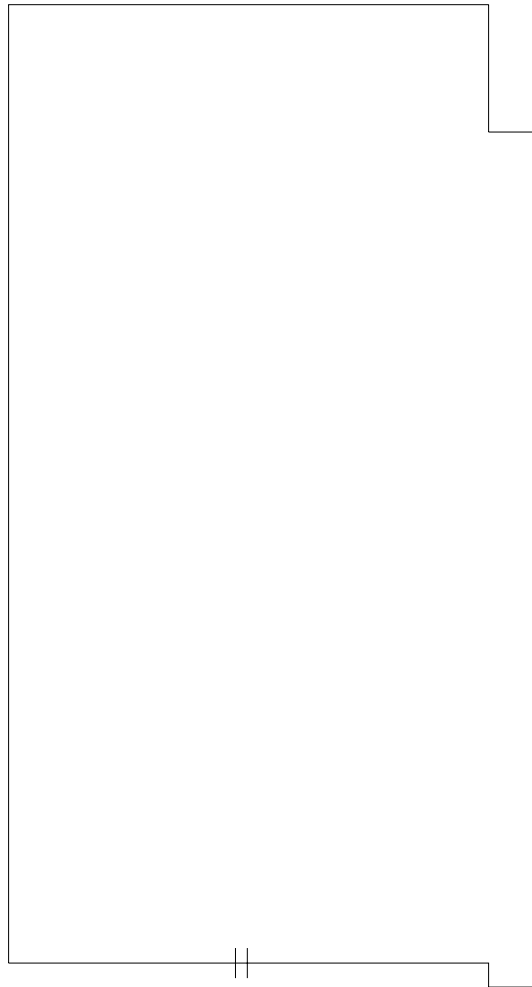

SYMBOLS KEY  
|| SCUPPER

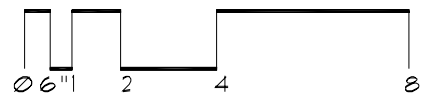
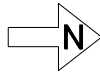



# Roof Corrective Action

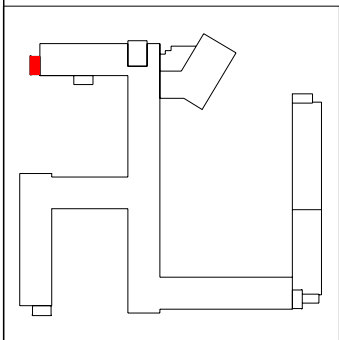
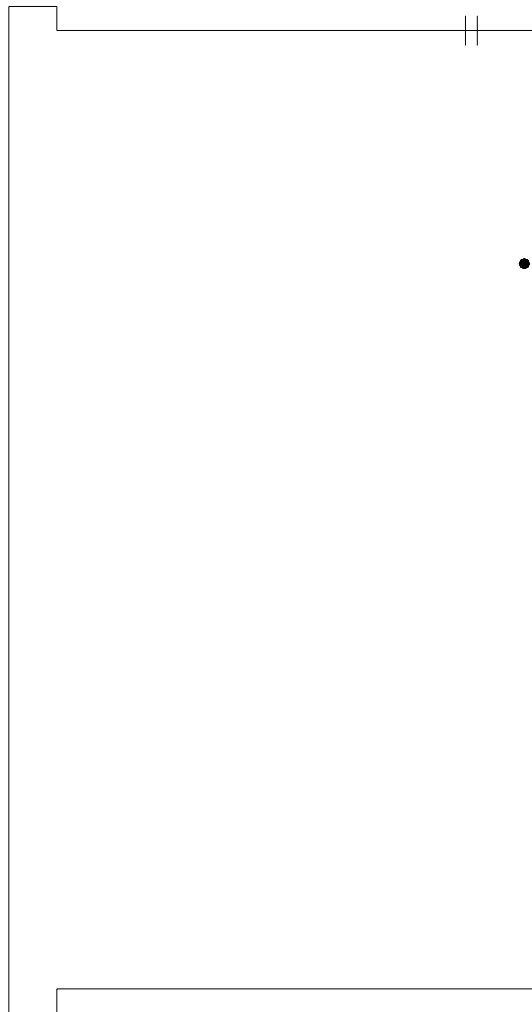

SYMBOLS KEY  
|| SCUPPER  
• ROOF DRAIN

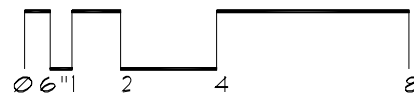

# Roof Corrective Action

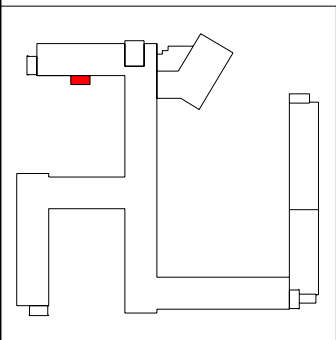
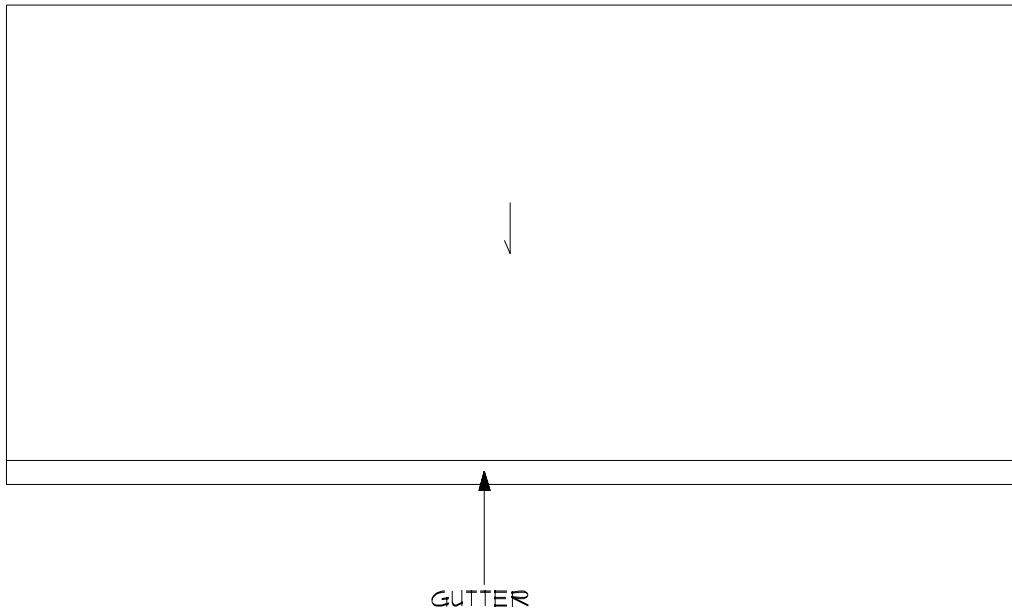

SYMBOLS KEY  
→ SLOPE DIRECTION

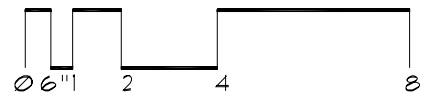

# Roof Corrective Action

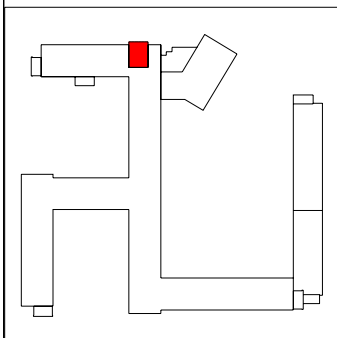
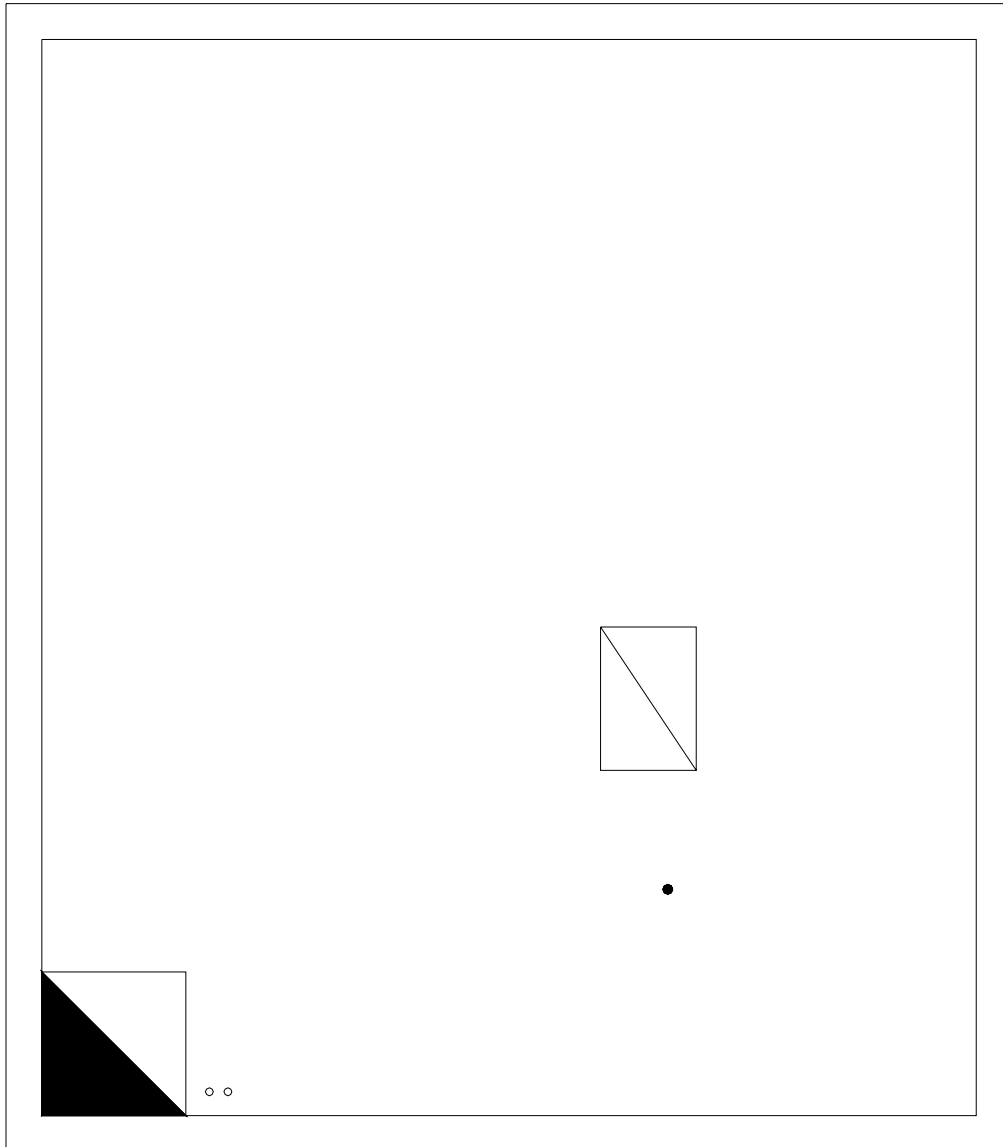

## SYMBOLS KEY

- ROOF DRAIN
- VENT STACK
- ▣ CHIMNEY
- ▤ ROOF HATCH

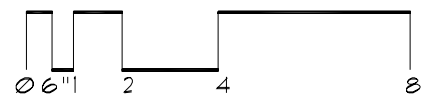
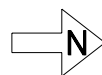

# Roof Corrective Action

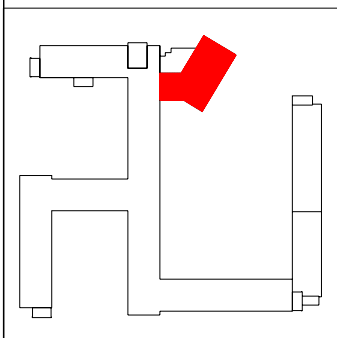
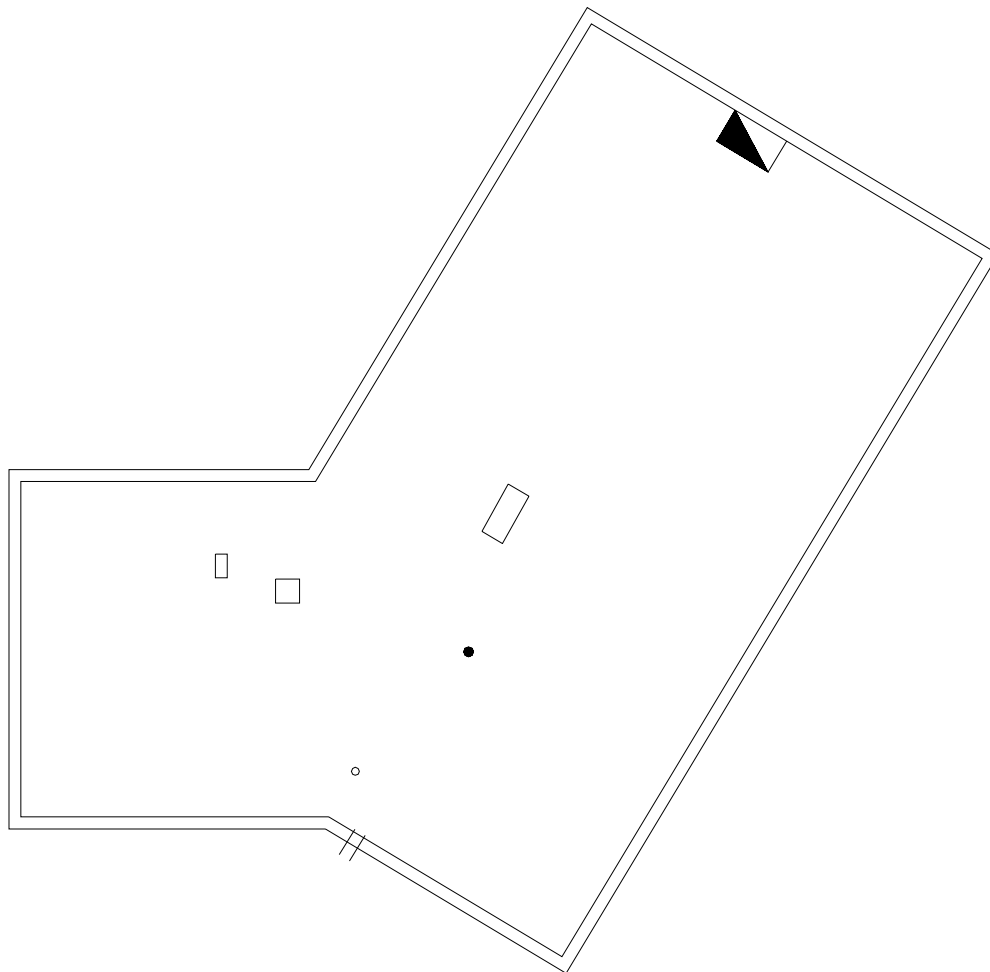

## SYMBOLS KEY

- ROOF CURB
- ROOF DRAIN
- VENT STACK
- ▴ CHIMNEY
- ⊖ DEFECT-NO REPAIR
- ⊕ DEFECT-REPAIR



# Roof Corrective Action

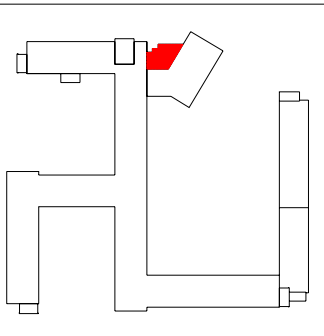
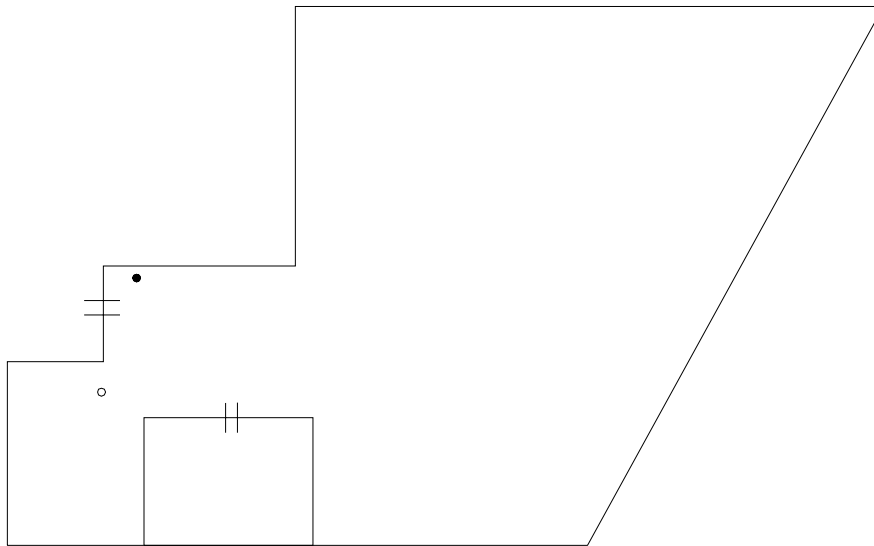

## SYMBOLS KEY

- ROOF DRAIN
- ⊥ SCUPPER
- ⊖ DEFECT-REPAIR
- VENT STACK
- ⓪ DEFECT-NO REPAIR

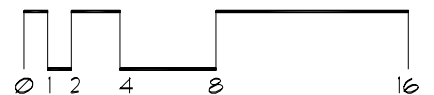

# Roof Corrective Action

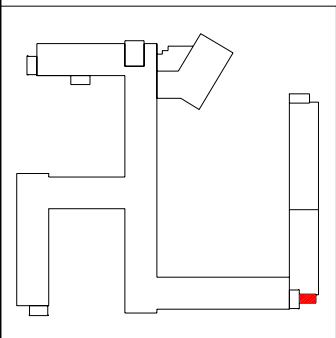
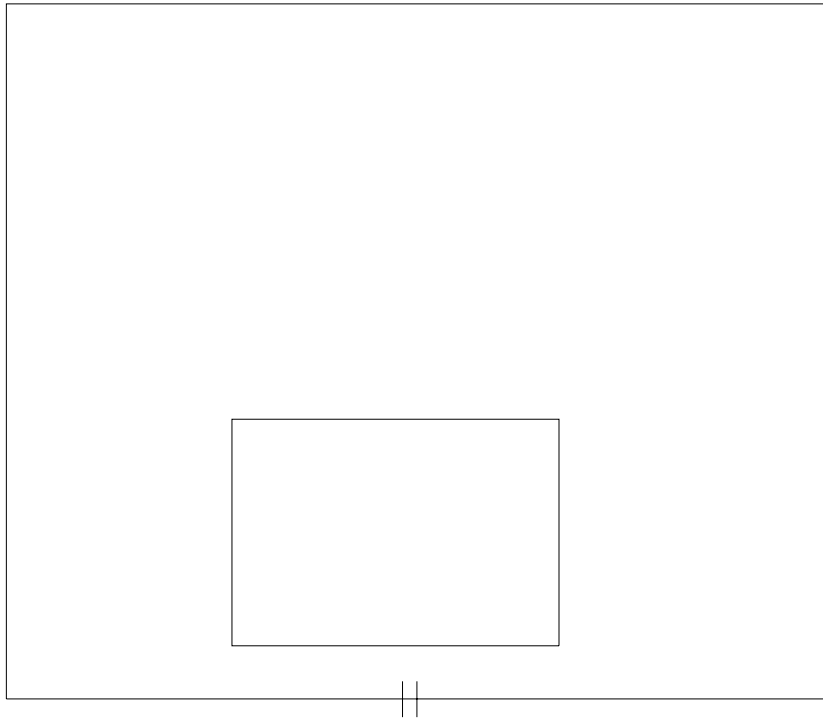

## SYMBOLS KEY

- ROOF CURB
- † SCUPPER
- ① DEFECT-NO REPAIR

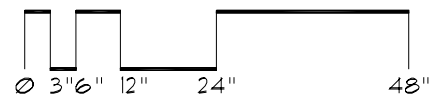

# Roof Corrective Action

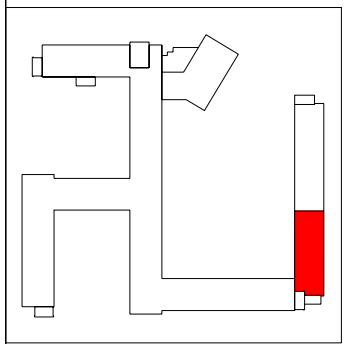
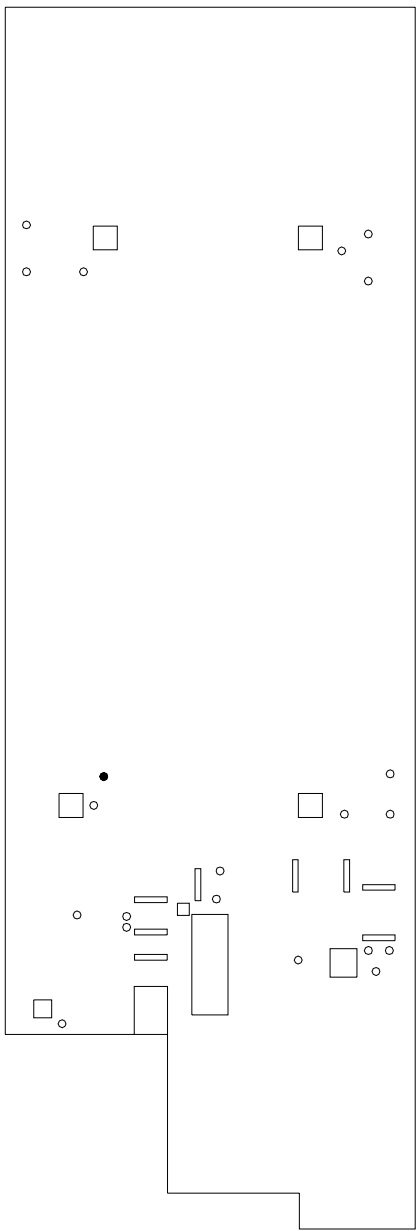

- SYMBOLS KEY**
- ROOF CURB
  - ROOF DRAIN
  - VENT STACK
  - Ⓢ DEFECT-REPAIR

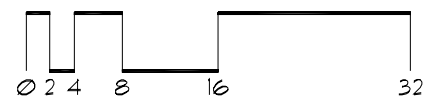

# Roof Corrective Action

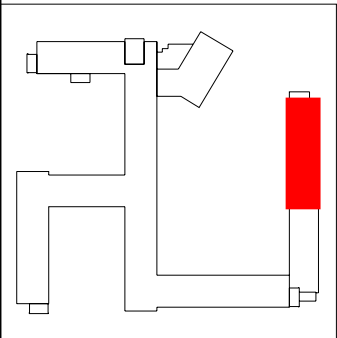
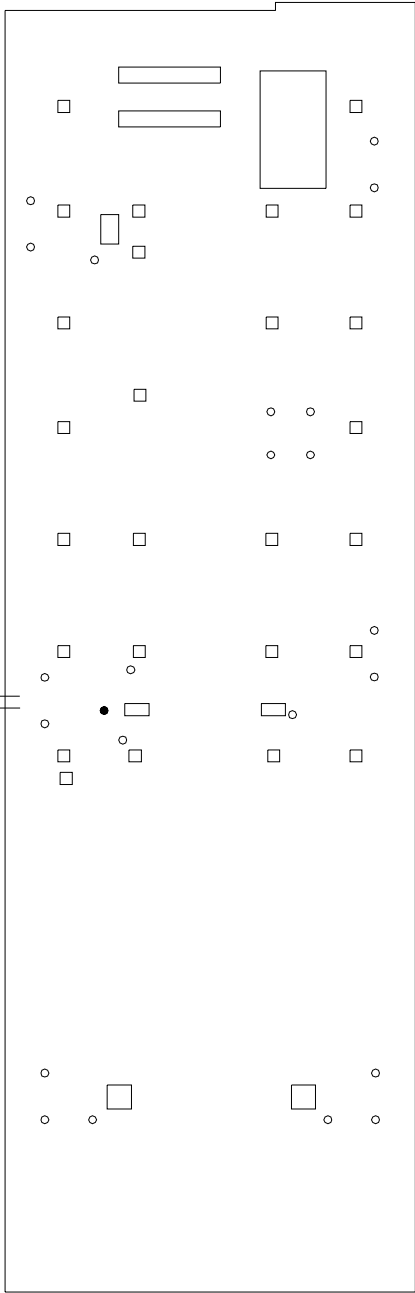

- SYMBOLS KEY**
- ROOF CURB
  - ROOF DRAIN
  - VENT STACK
  - ① DEFECT-REPAIR

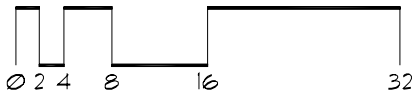



# Roof Corrective Action

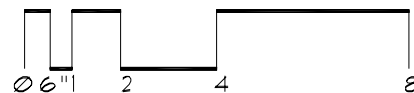
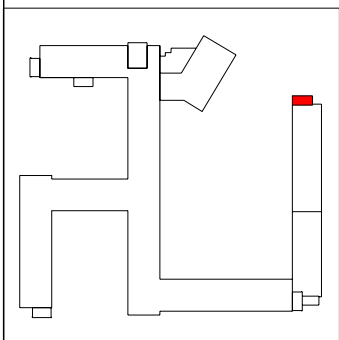
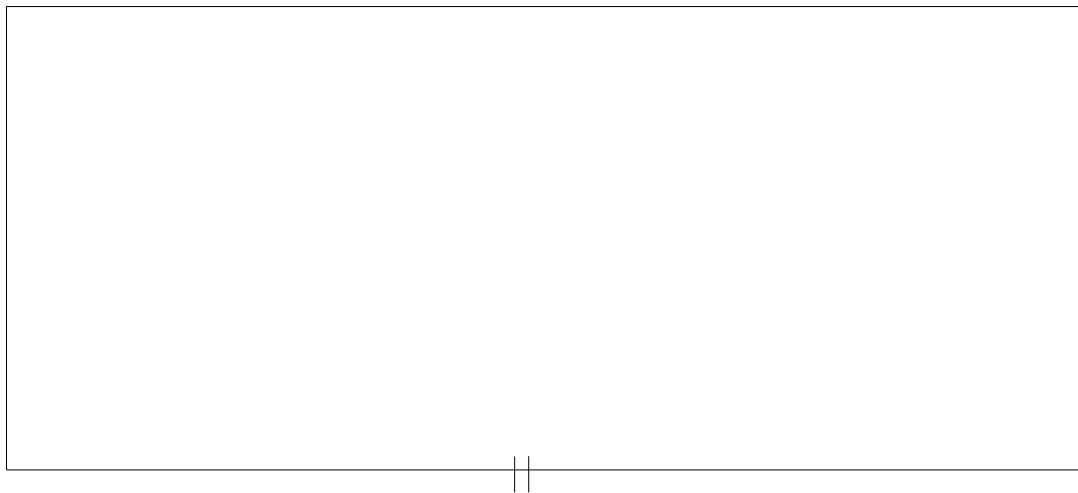

# Roof ID

**Building:** 120 - Pillsbury Court - (10th Ave & 5th St SE)

**Roof Access:** Ladder

**Total Area:** 23,664 sf

<u>A</u>	<u>2,958</u> sf	<u>E</u>	<u>2,958</u> sf
<u>B</u>	<u>2,958</u> sf	<u>F</u>	<u>2,958</u> sf
<u>C</u>	<u>2,958</u> sf	<u>G</u>	<u>2,958</u> sf
<u>D</u>	<u>2,958</u> sf	<u>H</u>	<u>2,958</u> sf

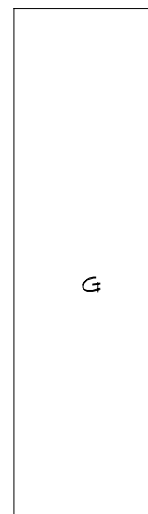
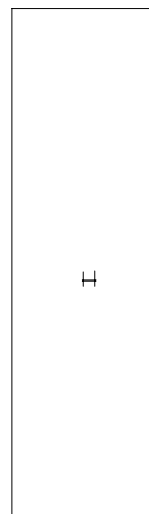
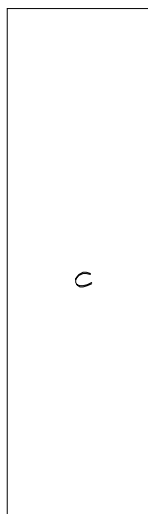
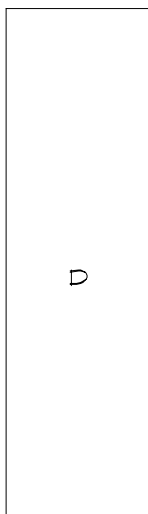
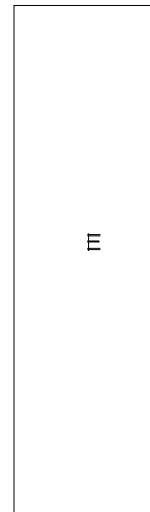
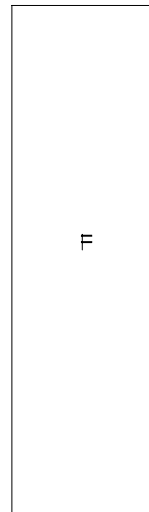
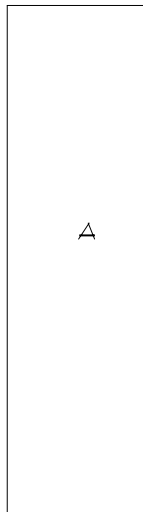
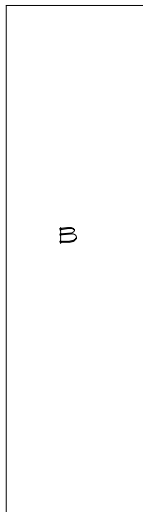

# Roof Corrective Action

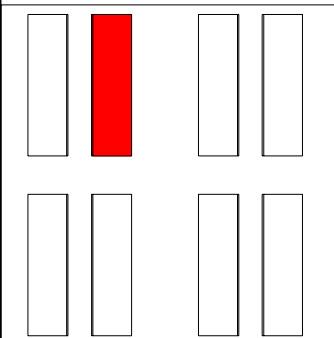
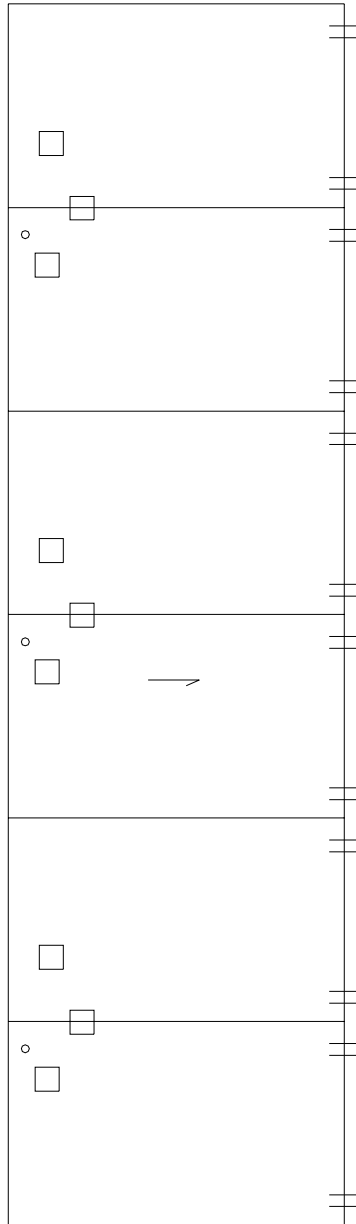

**SYMBOLS KEY**

- ROOF CURB
- SLOPE DIRECTION
- VENT STACK
- ⊥ SCUPPER
- Ⓢ DEFECT-REPAIR

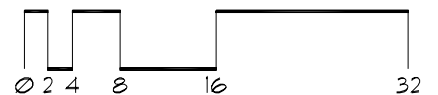

# Roof Corrective Action

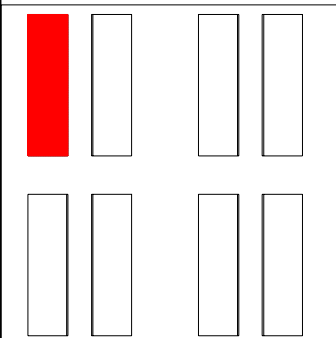
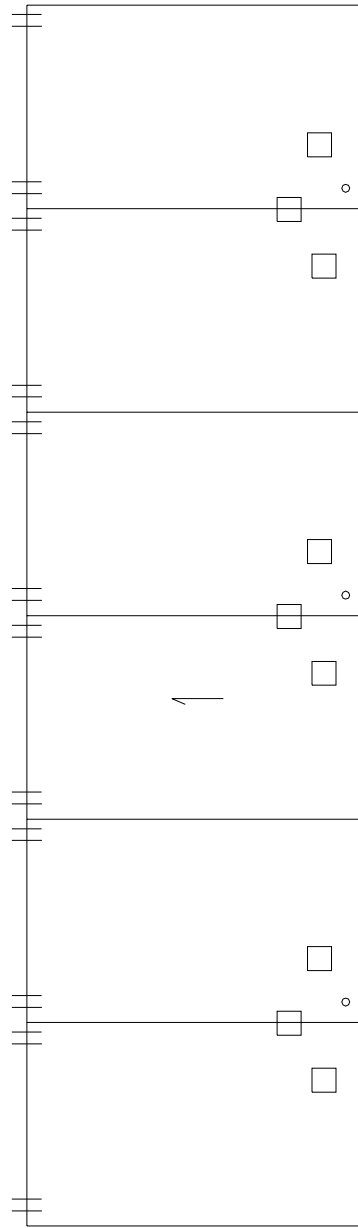

**SYMBOLS KEY**

- ROOF CURB
- VENT STACK
- SLOPE DIRECTION
- Ⓢ DEFECT-REPAIR
- ⦶ SCUPPER

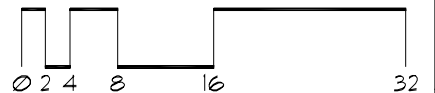

# Roof Corrective Action

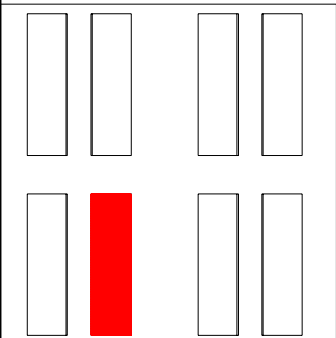
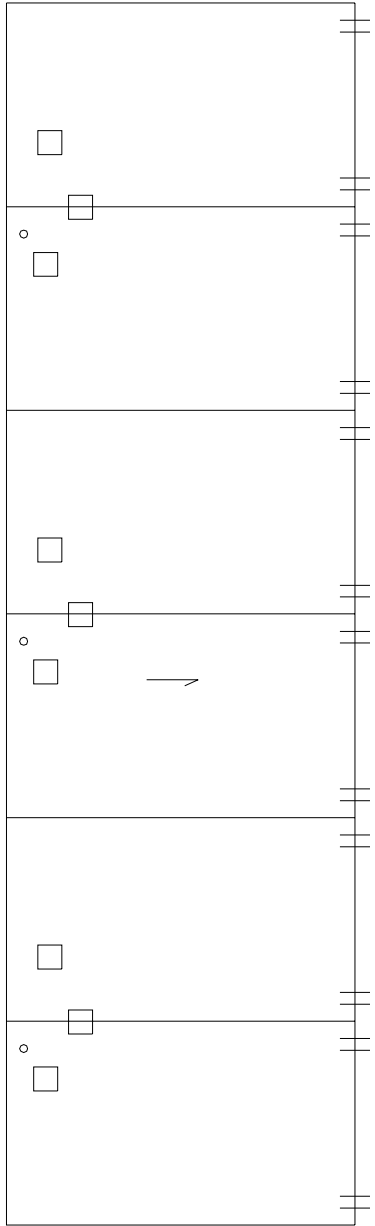

**SYMBOLS KEY**

- ROOF CURB
- VENT STACK
- SLOPE DIRECTION
- ≡ SCUPPER
- ⊖ DEFECT-REPAIR
- ⊕ DEFECT-NO REPAIR

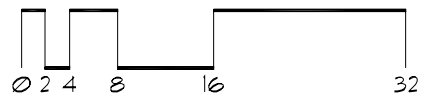

# Roof Corrective Action

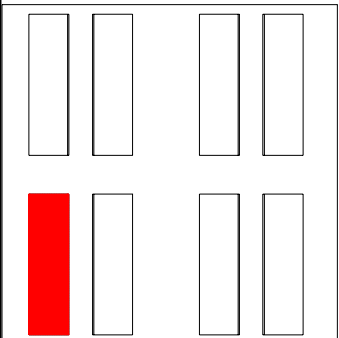
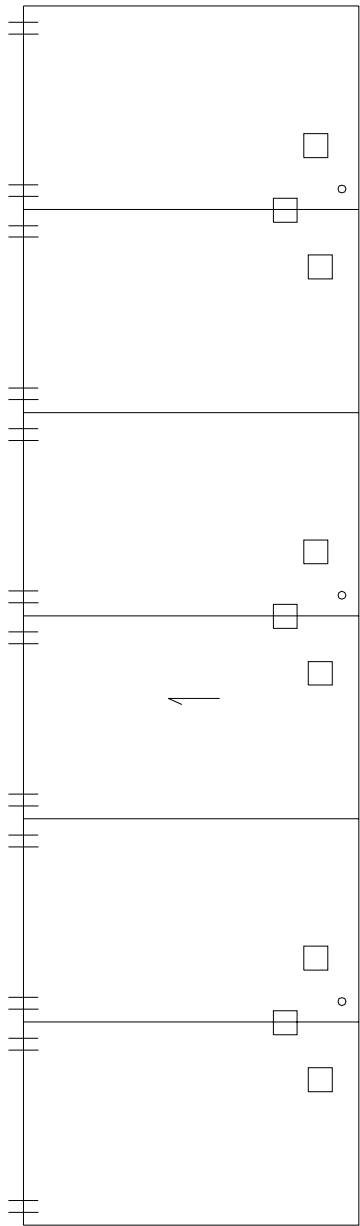

**SYMBOLS KEY**

- ROOF CURB
- VENT STACK
- SLOPE DIRECTION
- ⦶ SCUPPER
- ⊖ DEFECT-REPAIR
- ⊕ DEFECT-NO REPAIR

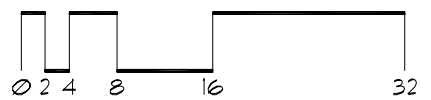

# Roof Corrective Action

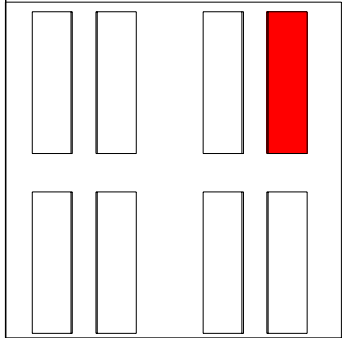
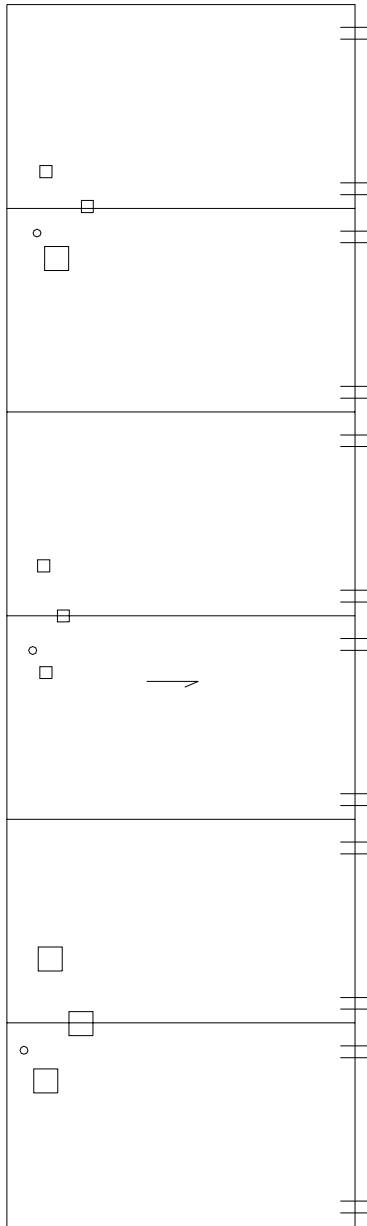

- SYMBOLS KEY**
- ROOF CURB
  - VENT STACK
  - ↘ SLOPE DIRECTION
  - ≡ SCUPPER

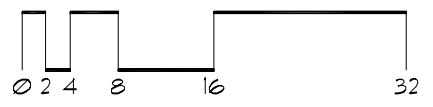

# Roof Corrective Action

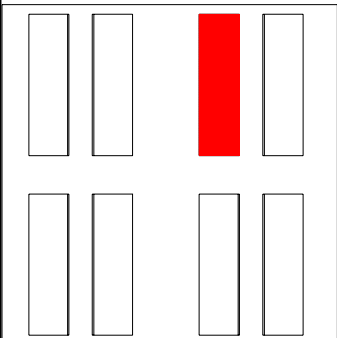
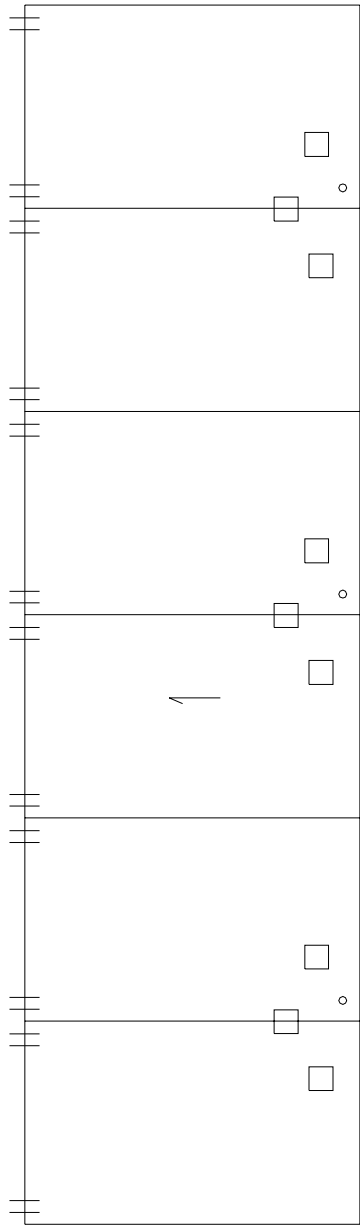

## SYMBOLS KEY

- ROOF CURB
- VENT STACK
- ↗ SLOPE DIRECTION
- ≡ SCUPPER
- ⊕ DEFECT-NO REPAIR

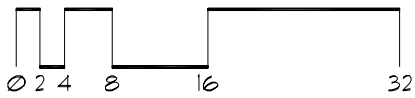



# Roof Corrective Action

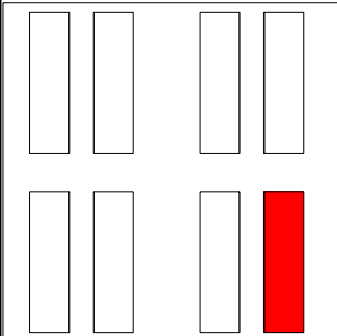
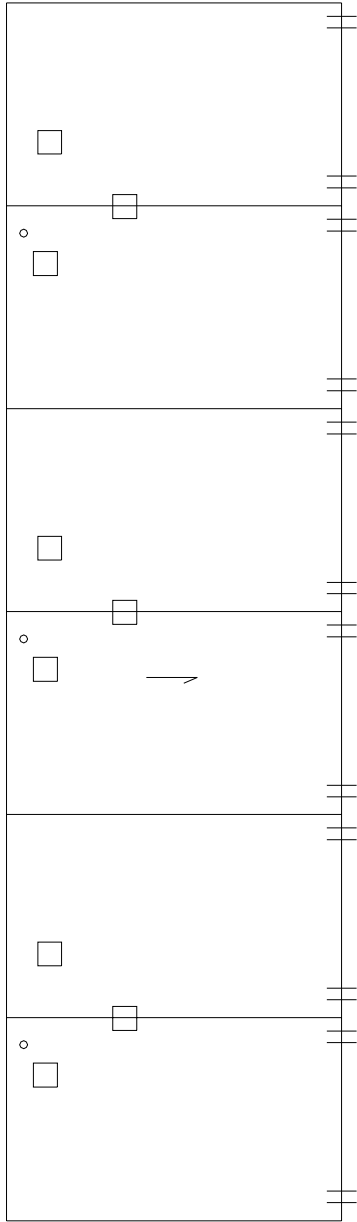

**SYMBOLS KEY**

- ROOF CURB
- VENT STACK
- SLOPE DIRECTION
- ≡ SCUPPER

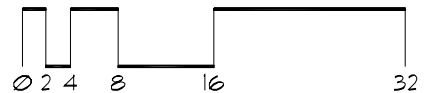

# Roof Corrective Action

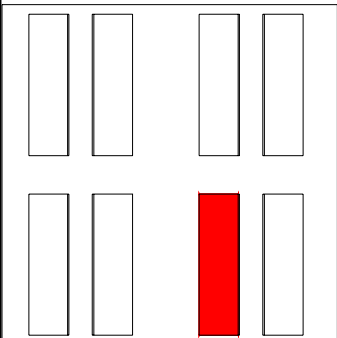
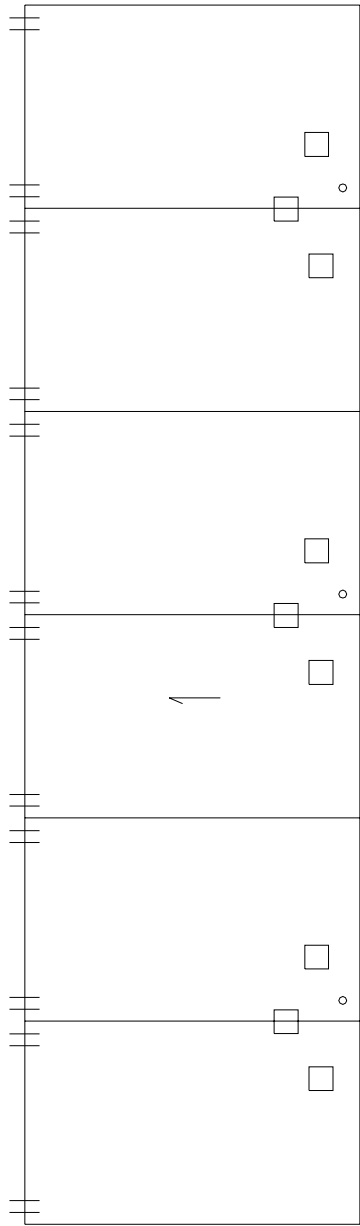

## SYMBOLS KEY

- ROOF CURB
- VENT STACK
- SLOPE DIRECTION
- ≡ SCUPPER
- ⓪ DEFECT-NO REPAIR

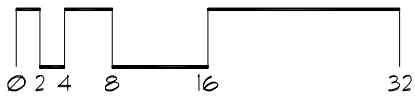

# Roof ID

Building: 052 - Pioneer Hall - (615 Fulton St. SE)

Total Area: 46,626 sf

<u>A</u>	<u>17,064</u> sf	<u>E</u>	<u>17,064</u> sf
<u>B</u>	<u>1,560</u> sf	<u>F</u>	<u>2,206</u> sf
<u>C</u>	<u>1,162</u> sf	<u>G</u>	<u>2,280</u> sf
<u>D</u>	<u>5,290</u> sf		

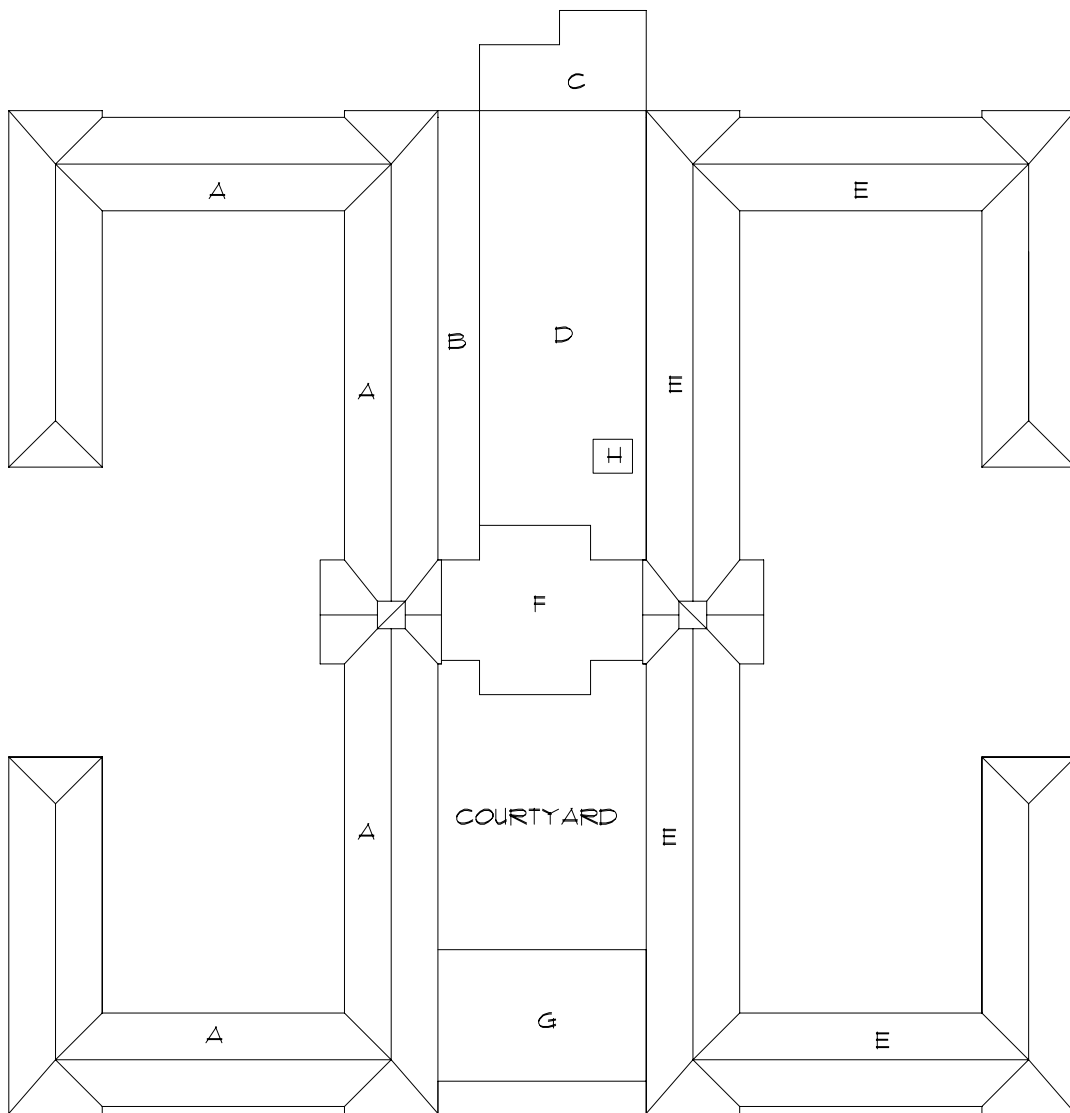

SYMBOLS KEY

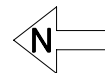

# Roof Corrective Action

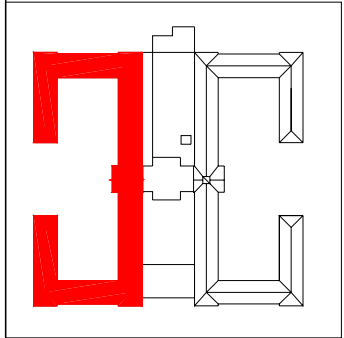
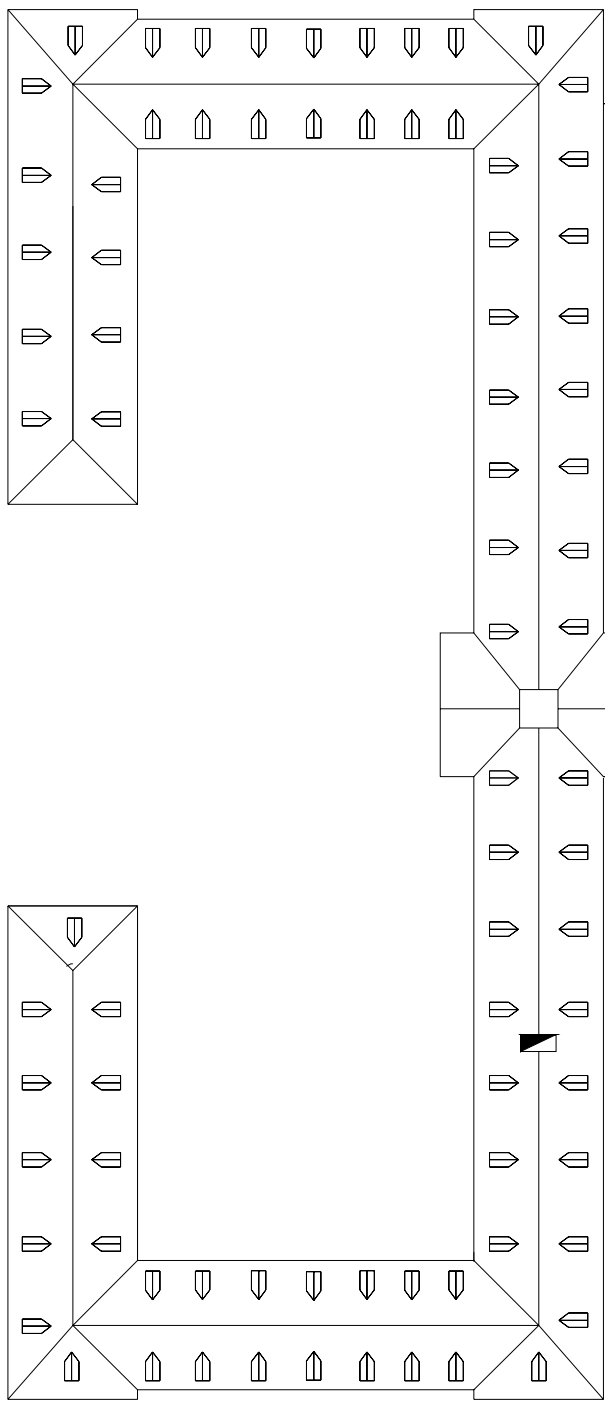

**SYMBOLS KEY**  
■ CHIMNEY  
ⓐ DEFECT-NO REPAIR

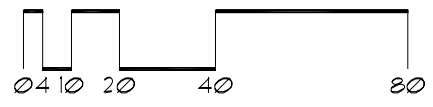
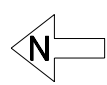

# Roof Corrective Action

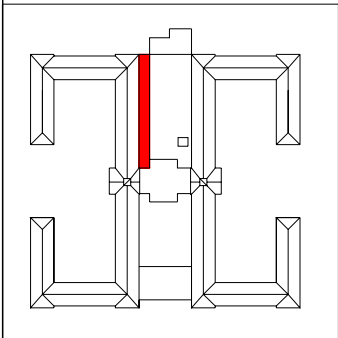
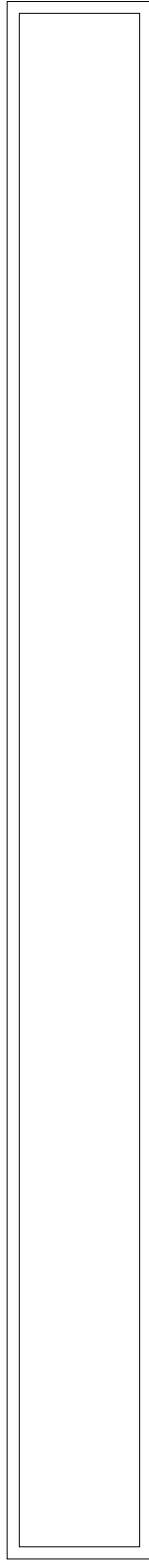

SYMBOLS KEY

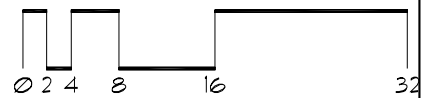

# Roof Corrective Action

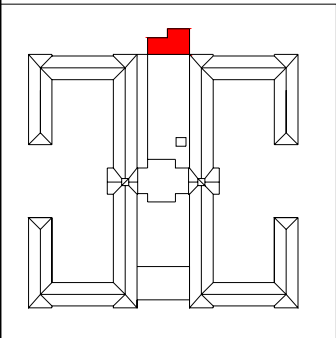
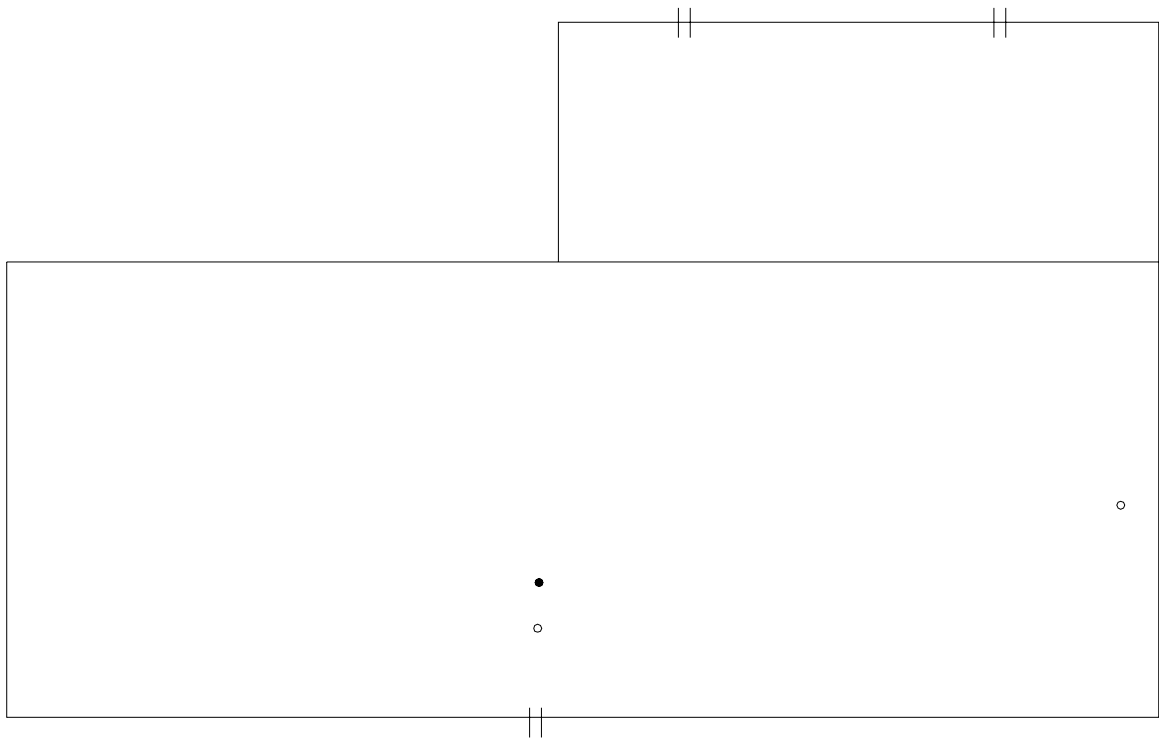

**SYMBOLS KEY**  
● ROOF DRAIN  
○ VENT STACK  
|| SCUPPER

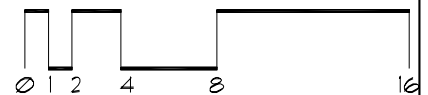

# Roof Corrective Action

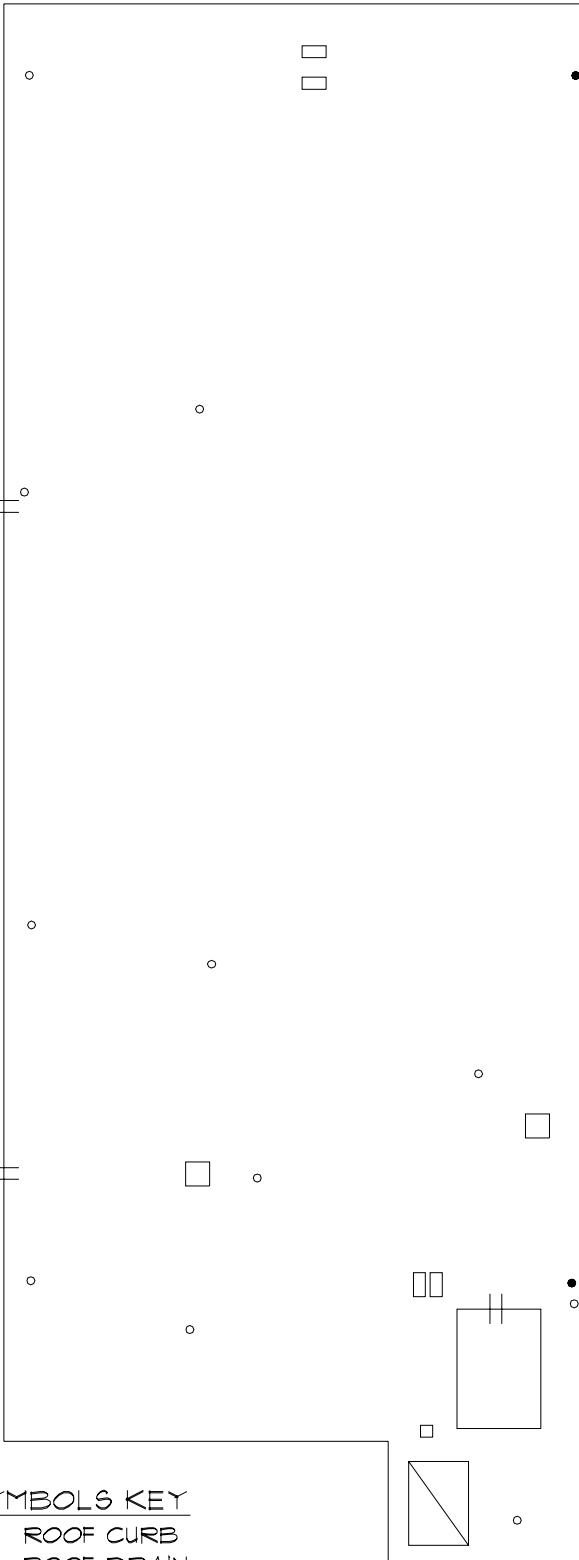

- SYMBOLS KEY**
- ROOF CURB
  - ROOF DRAIN
  - VENT STACK
  - † SCUPPER
  - ▣ ROOF HATCH
  - DEFECT-REPAIR
  - ① DEFECT-NO REPAIR

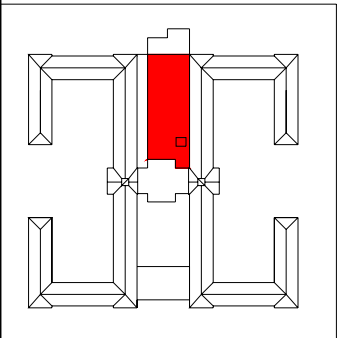
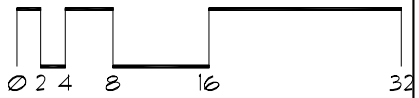

# Roof Corrective Action

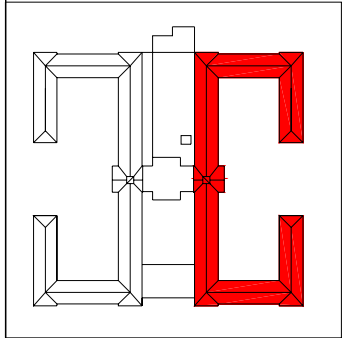
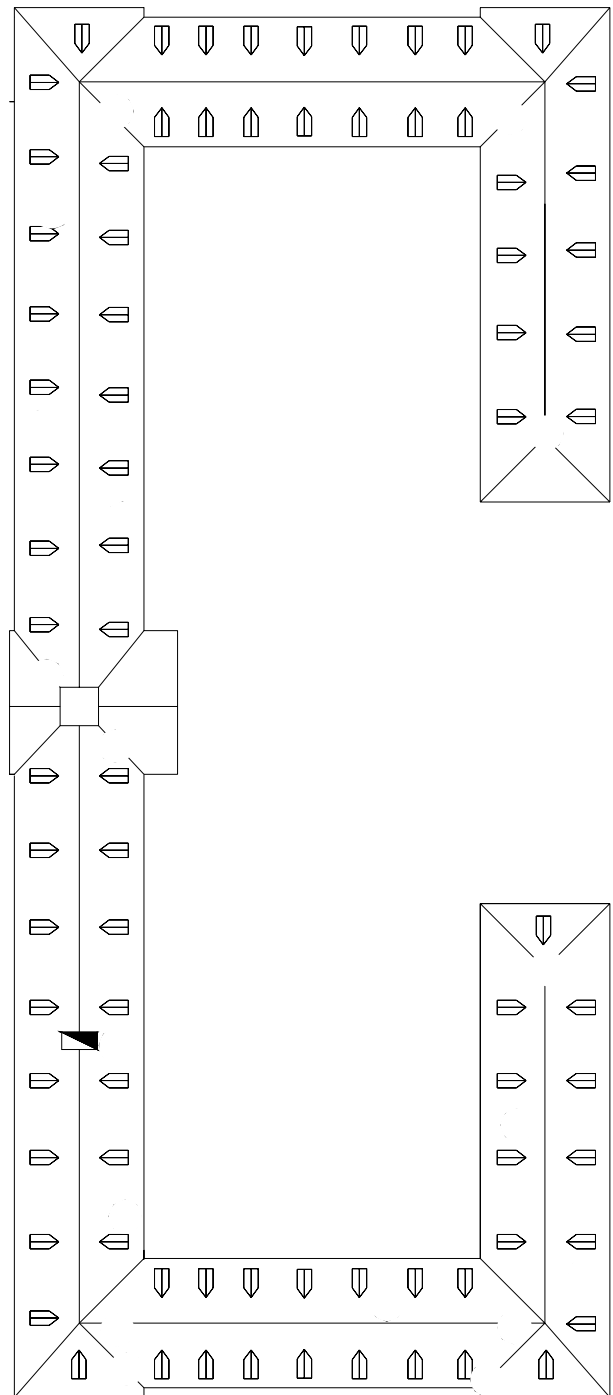

SYMBOLS KEY  
■ CHIMNEY  
⓪ DEFECT-NO REPAIR

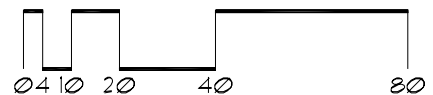
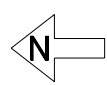



# Roof Corrective Action

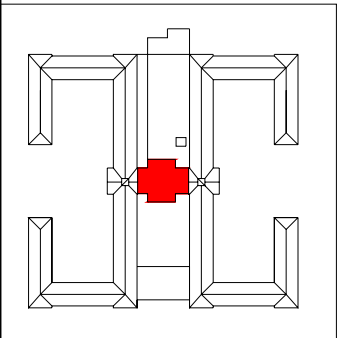
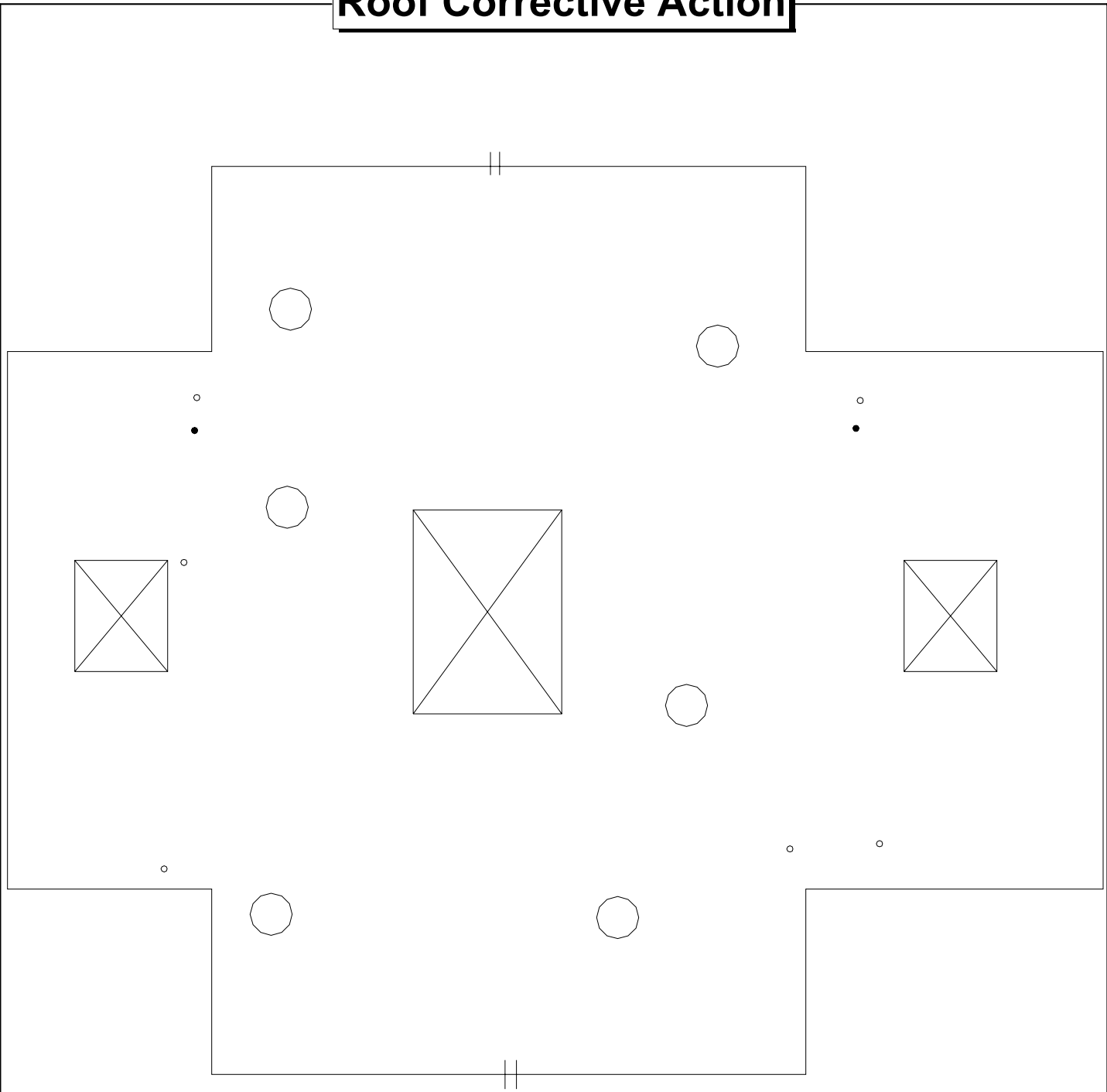

- SYMBOLS KEY**
- ROOF DRAIN
  - VENT STACK
  - ⦶ SCUPPER
  - ⊠ SKYLIGHT

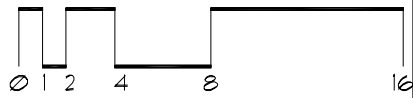

# Roof Corrective Action

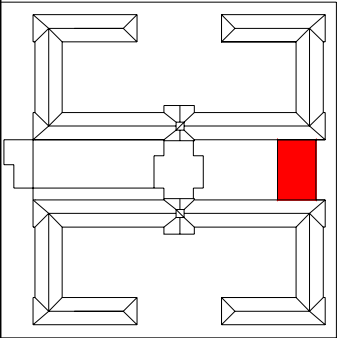
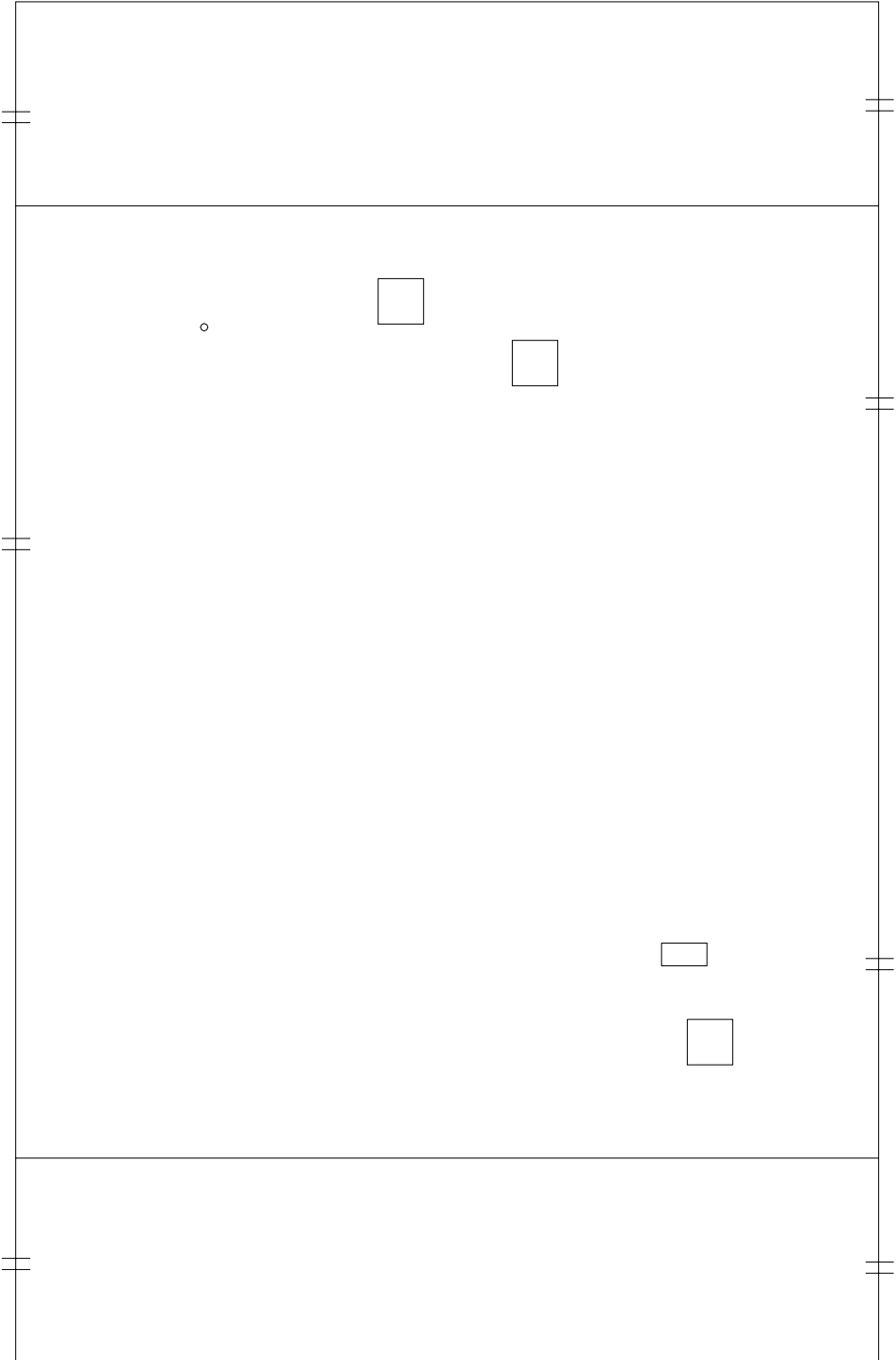

SYMBOLS KEY  
□ ROOF CURB  
○ VENT STACK  
† SCUPPER

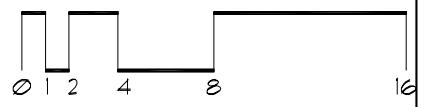
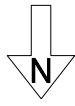

# Roof ID

Building: EB028 - Sanford Hall - (1122 University Ave SE)

Total Area: 50,259 sf

A	242	E	5,074	I	30,155	M	230
B	465	F	850	J	1,100		
C	242	G	450	K	7,500		
D	1,221	H	1,480	L	1,250		

## SYMBOLS KEY

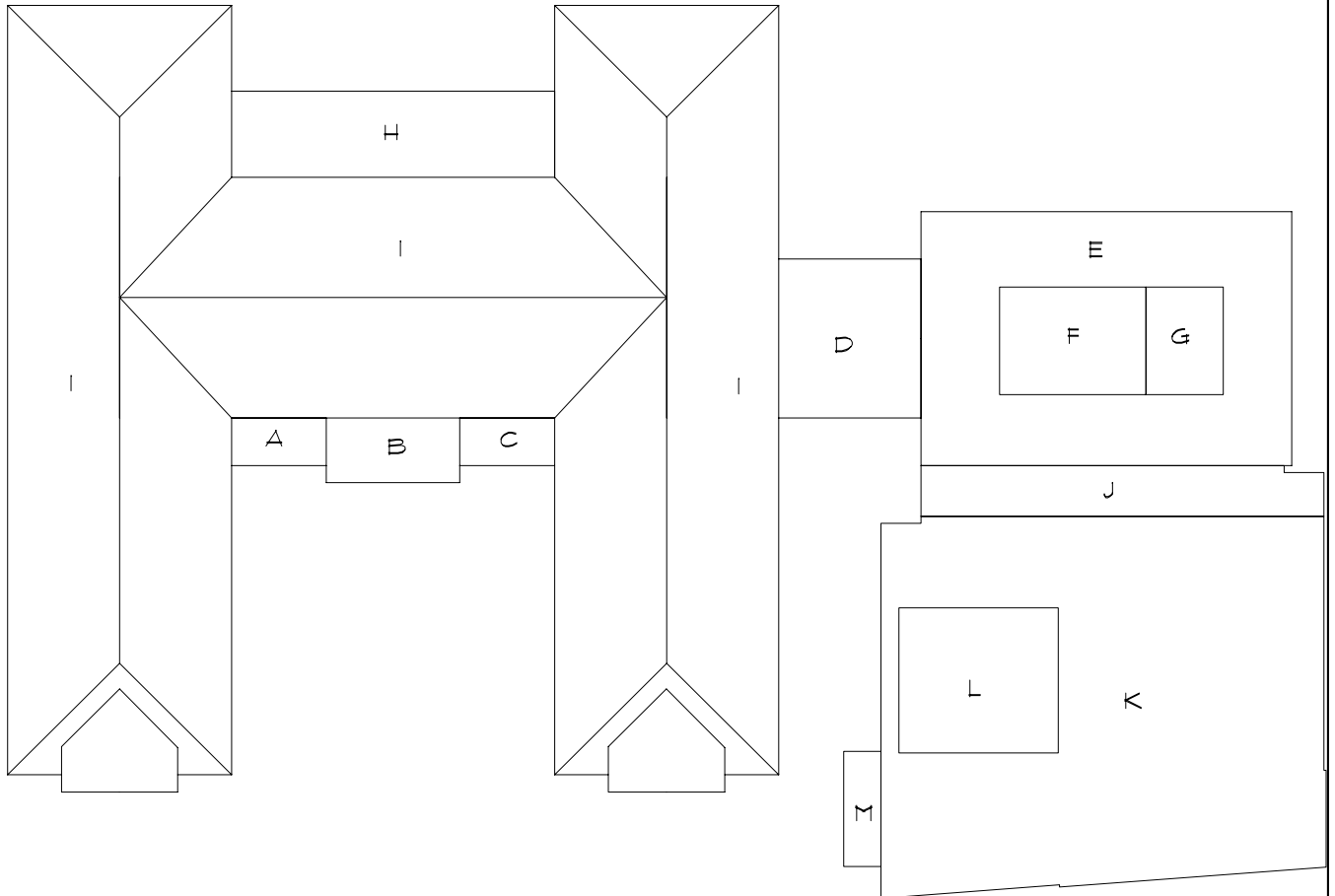

# Roof Corrective Action

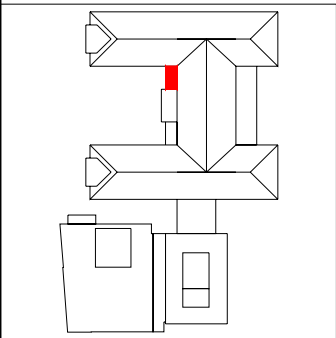
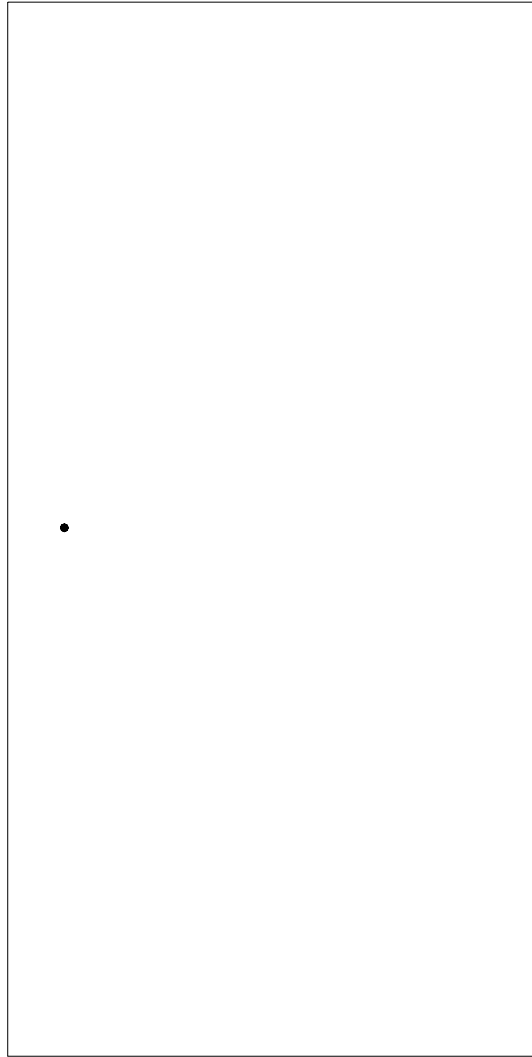

## SYMBOLS KEY

- ROOF CURB
- ROOF DRAIN
- ① DEFECT-NO REPAIR

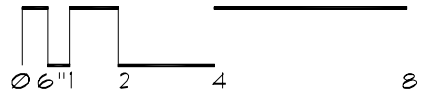

# Roof Corrective Action

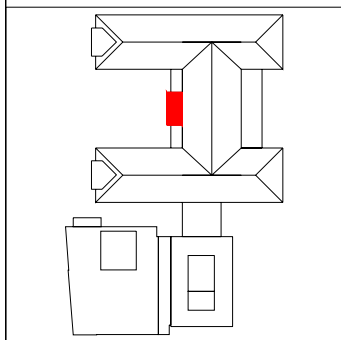
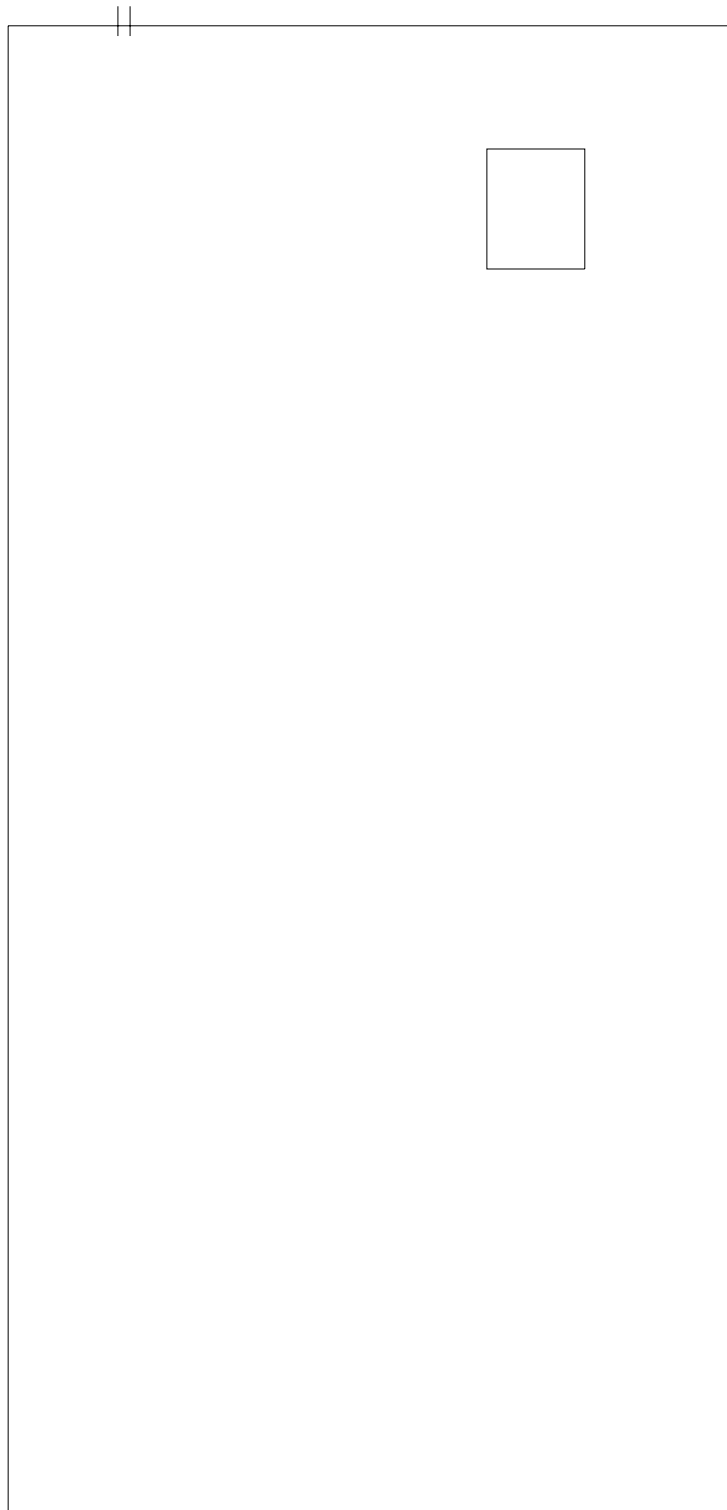

- SYMBOLS KEY**
- ⊥ SCUPPER
  - Ⓢ DEFECT-REPAIR
  - ROOF CURB

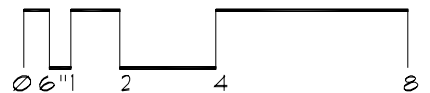

# Roof Corrective Action

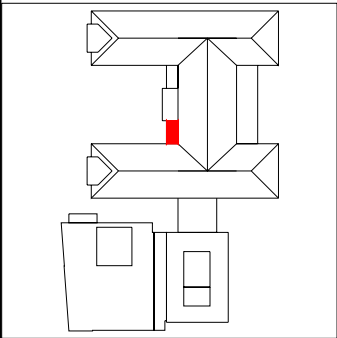

- SYMBOLS KEY
- ROOF DRAIN
  - ⓪ DEFECT-NO REPAIR
  - Ⓢ DEFECT-REPAIR

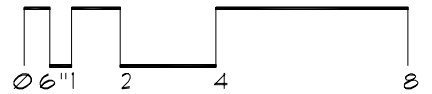

# Roof Corrective Action

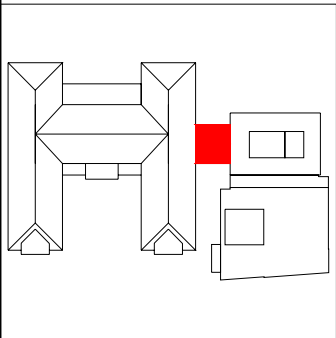
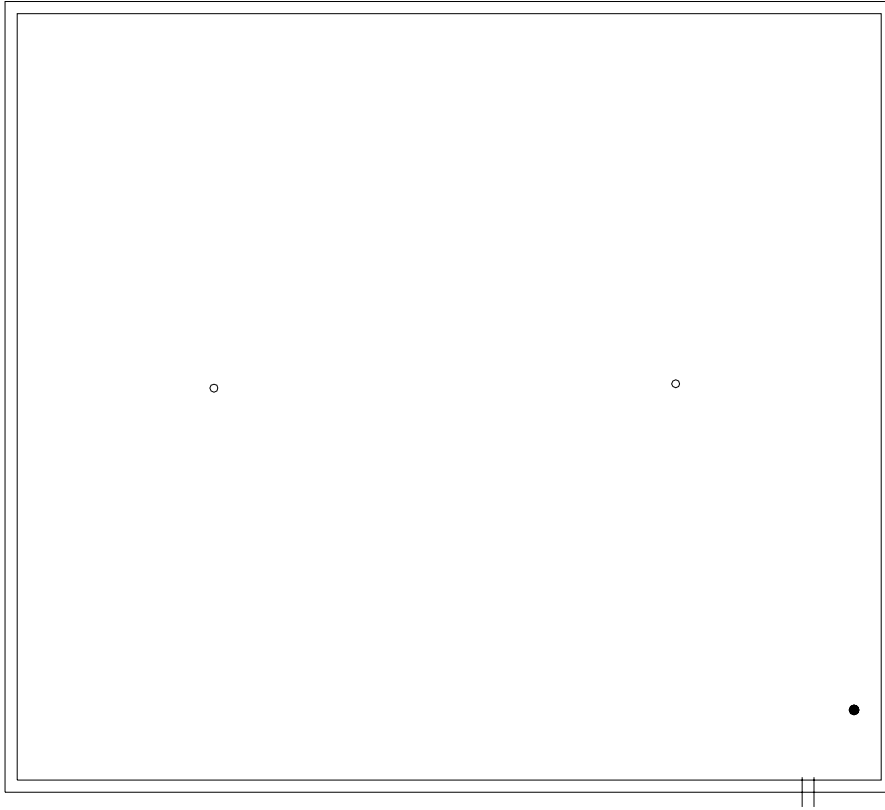

SYMBOLS KEY	
●	ROOF DRAIN
○	VENT STACK
≡	SCUPPER

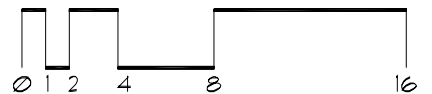

# Roof Corrective Action

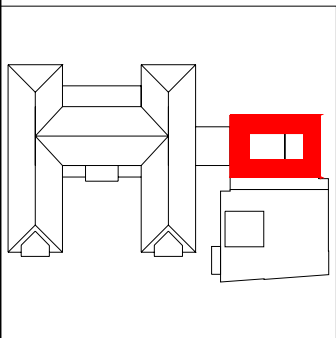
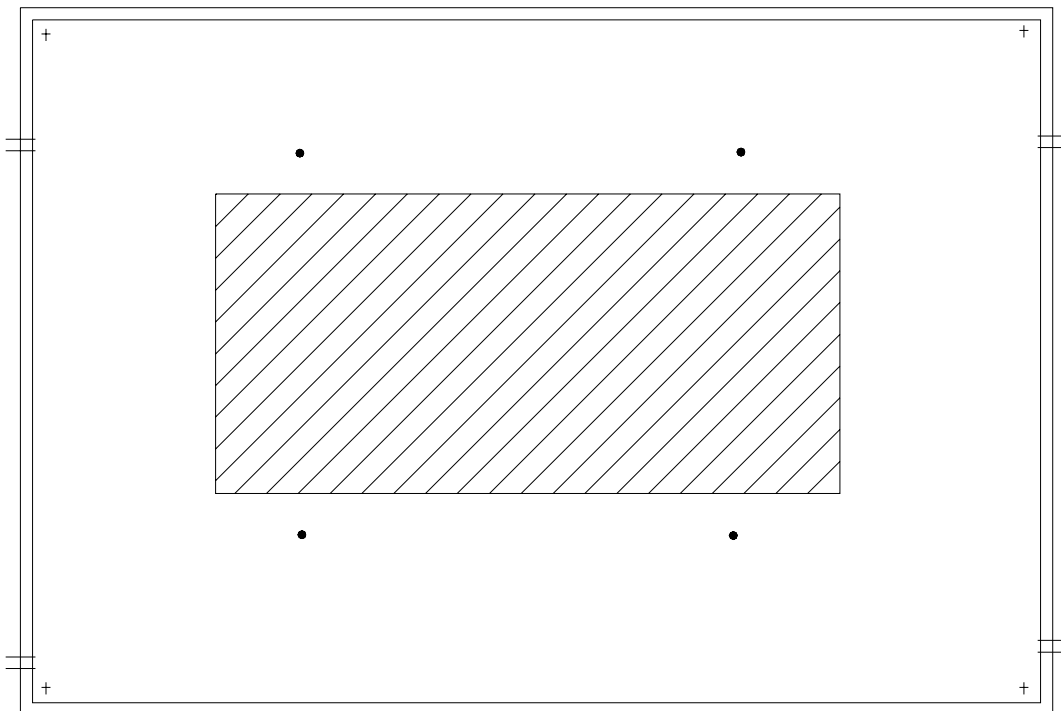

## SYMBOLS KEY

- ROOF DRAIN
- ≡ SCUPPER
- † FLASHED PENETRATION

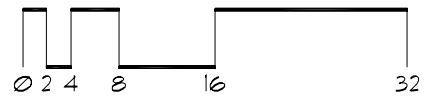



# Roof Corrective Action

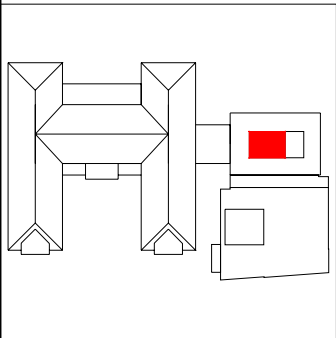
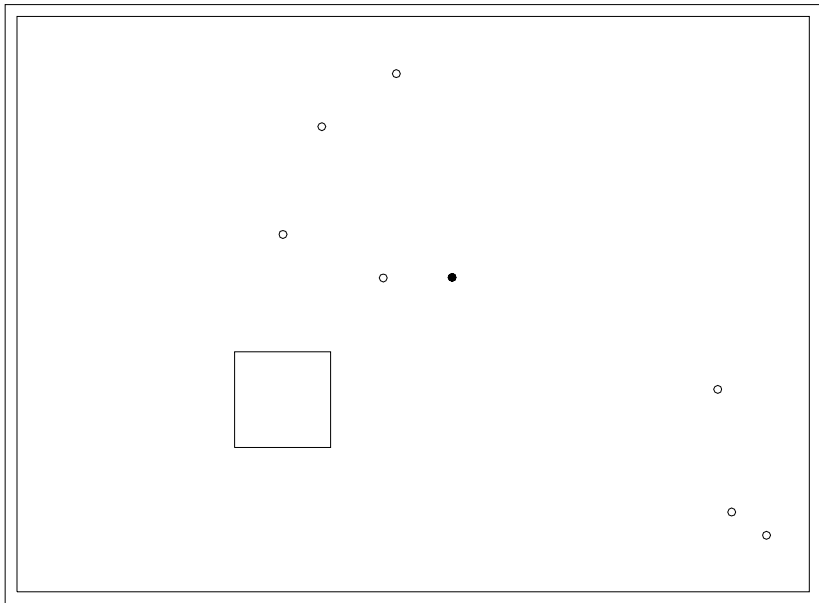

## SYMBOLS KEY

- ROOF CURB OR VENT
- ROOF DRAIN
- VENT STACK

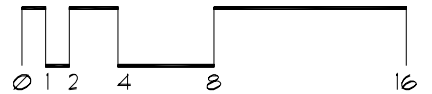

# Roof Corrective Action

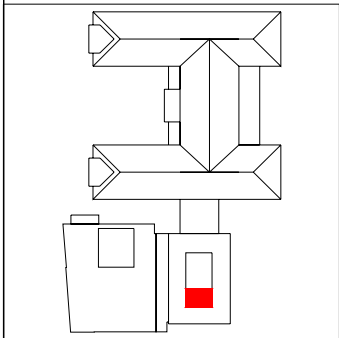
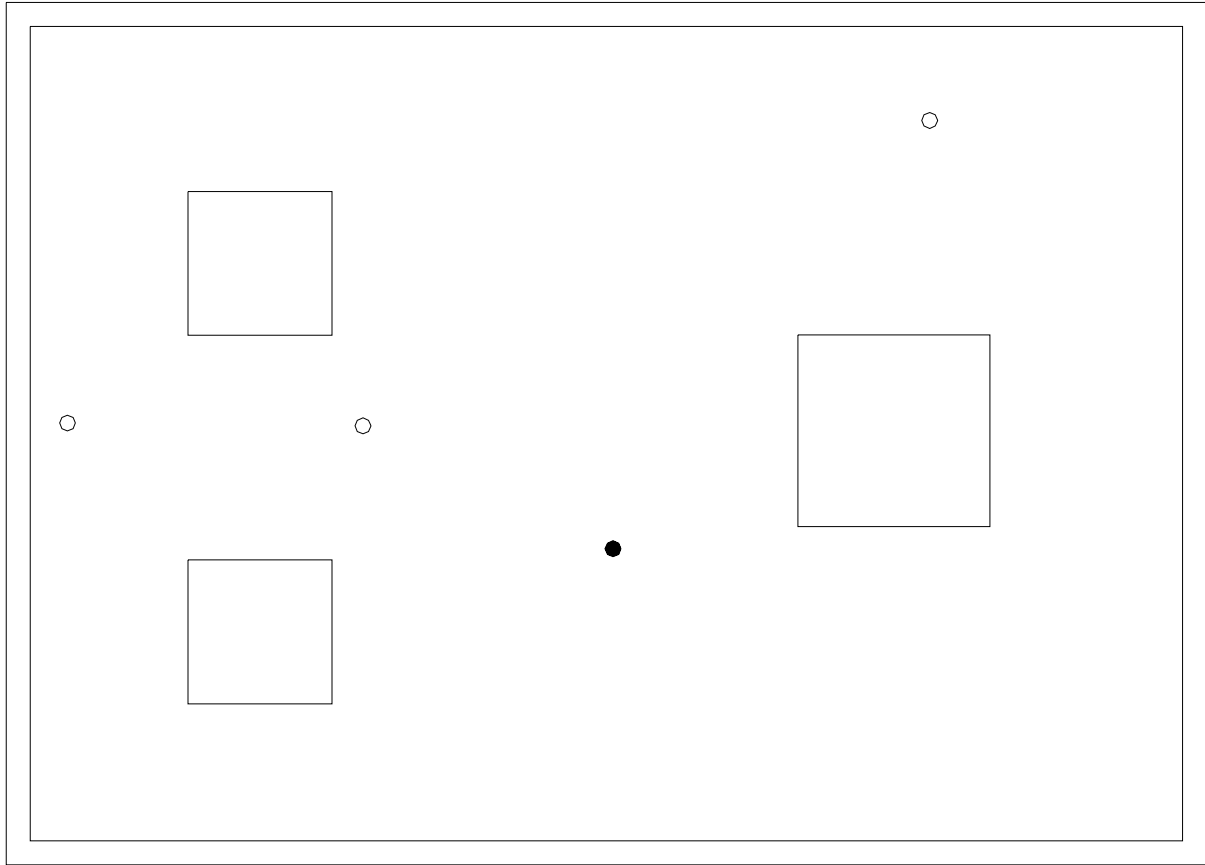

## SYMBOLS KEY

- ROOF CURB
- ROOF DRAIN
- VENT STACK

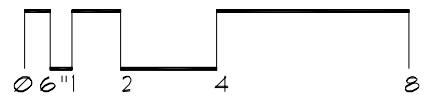

# Roof Corrective Action

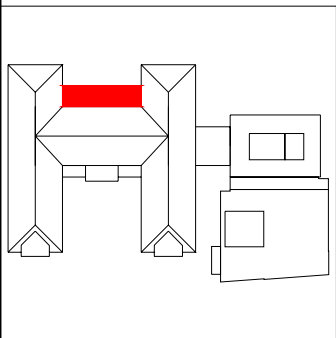
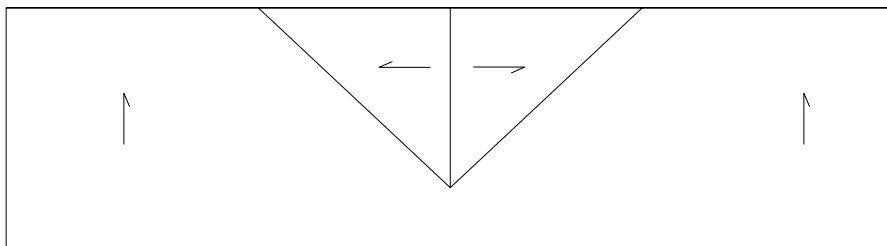

SYMBOLS KEY  
→ SLOPE DIRECTION

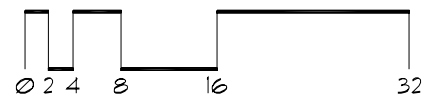

# Roof Corrective Action

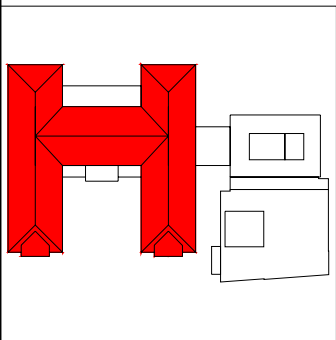
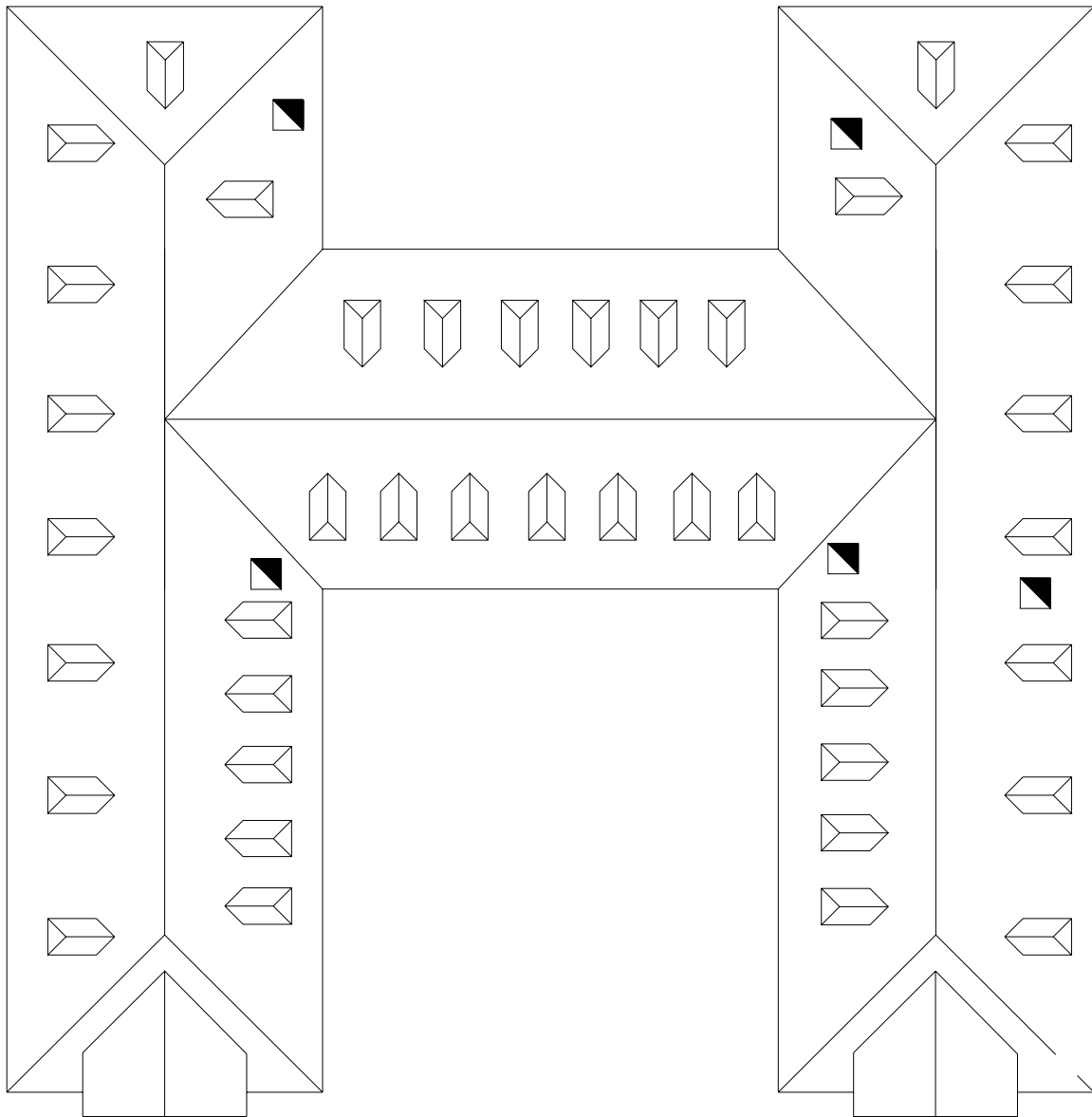

## SYMBOLS KEY

- CHIMNEY
- ⓧ DEFECT-REPAIR

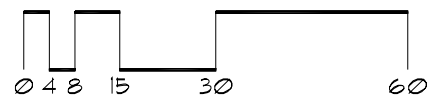

# Roof Corrective Action

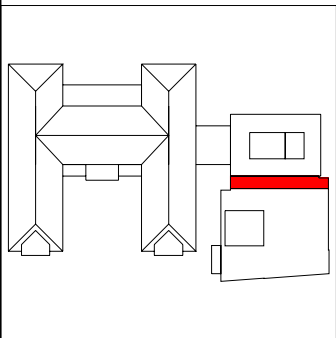
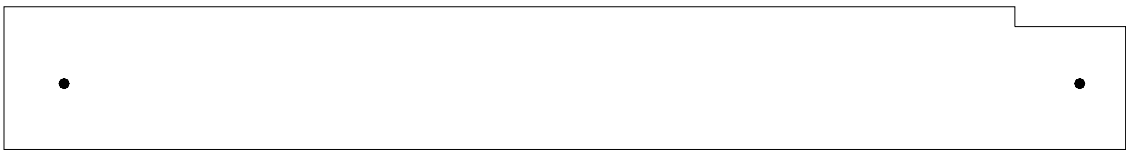

SYMBOLS KEY  
• ROOF DRAIN

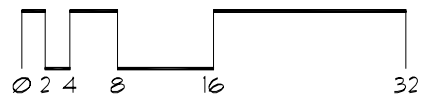

# Roof Corrective Action

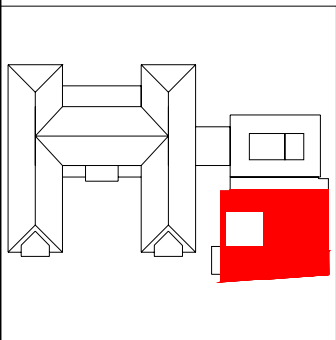
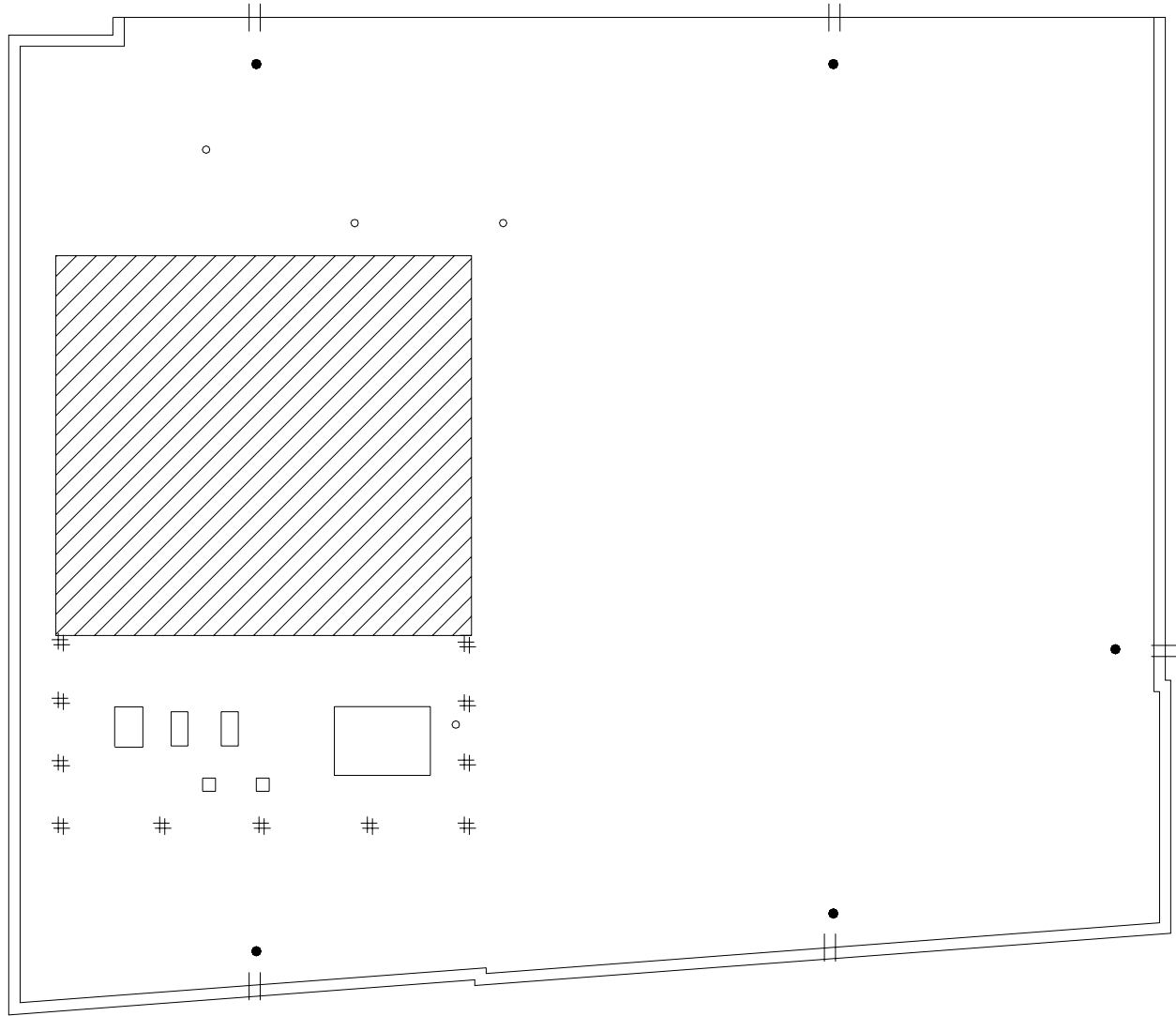

**SYMBOLS KEY**

- ROOF CURB
- ROOF DRAIN
- || SCUPPER
- VENT STACK
- # PITCH PAN
- Ⓡ DEFECT-REPAIR

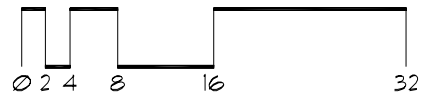

# Roof Corrective Action

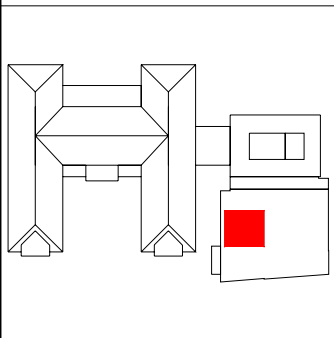
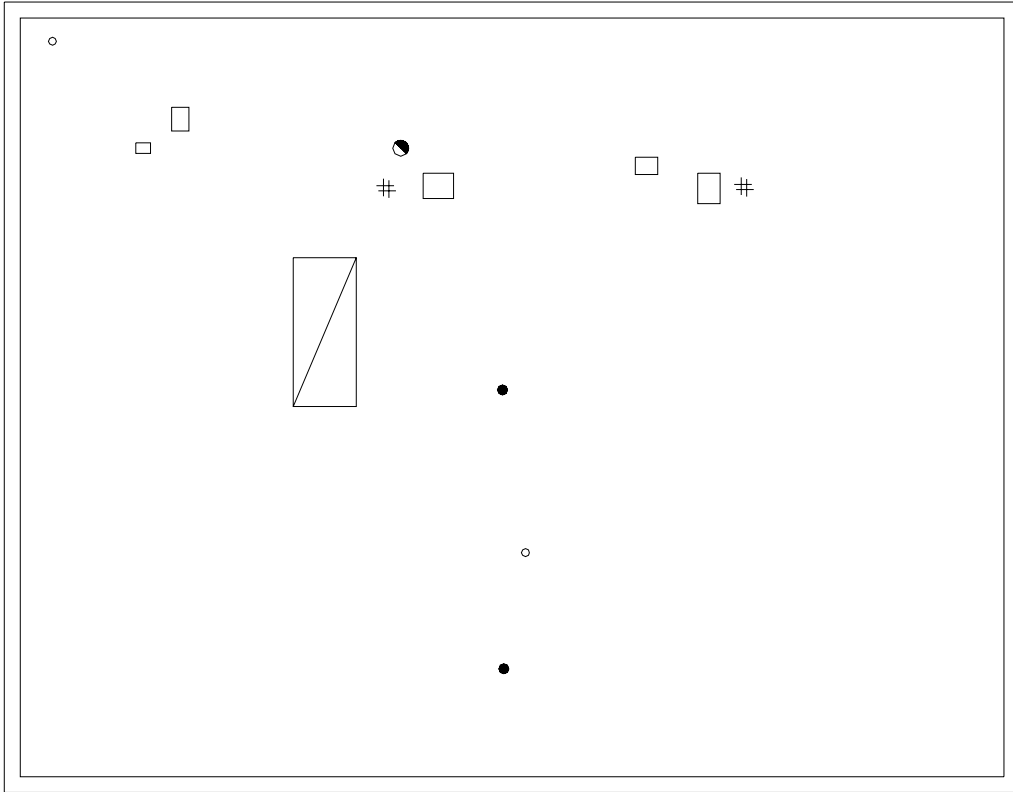

## SYMBOLS KEY

- ROOF DRAIN
- ⊕ SCUPPER
- ▣ ROOF HATCH
- ROOF CURB
- Ⓢ DEFECT-REPAIR

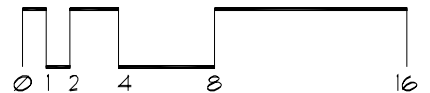

# Roof Corrective Action

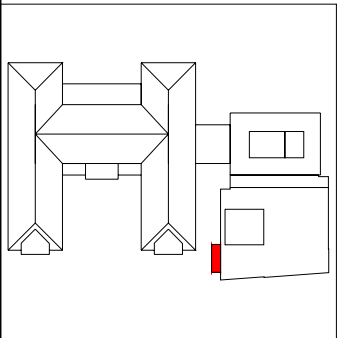
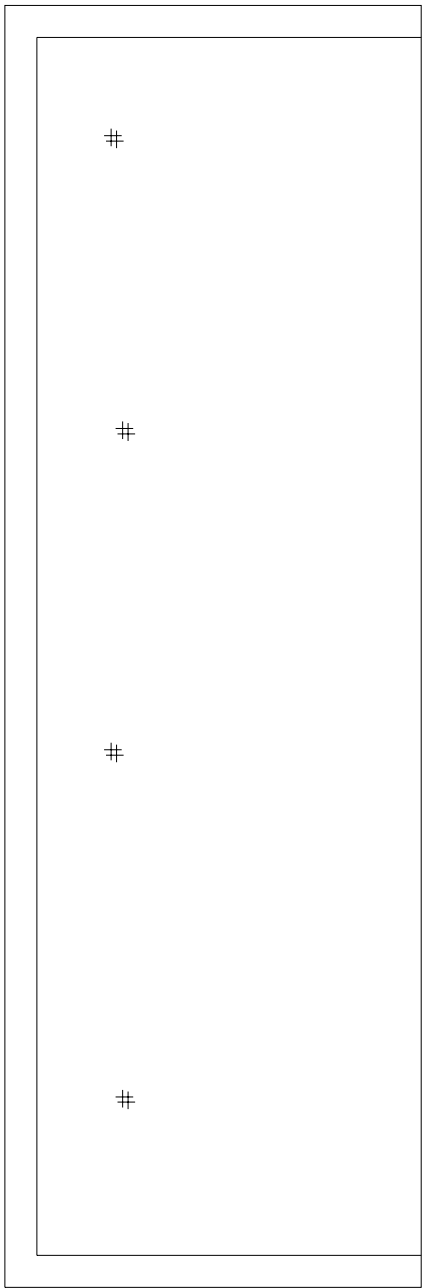

SYMBOLS KEY  
# PITCH PAN

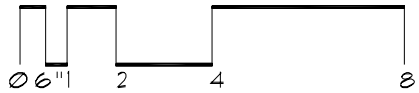



# Roof ID

Building: EB030 - Roy Wilkins Hall - (1212 University Ave SE)

Total Area: 19,165 sf

A 19,165

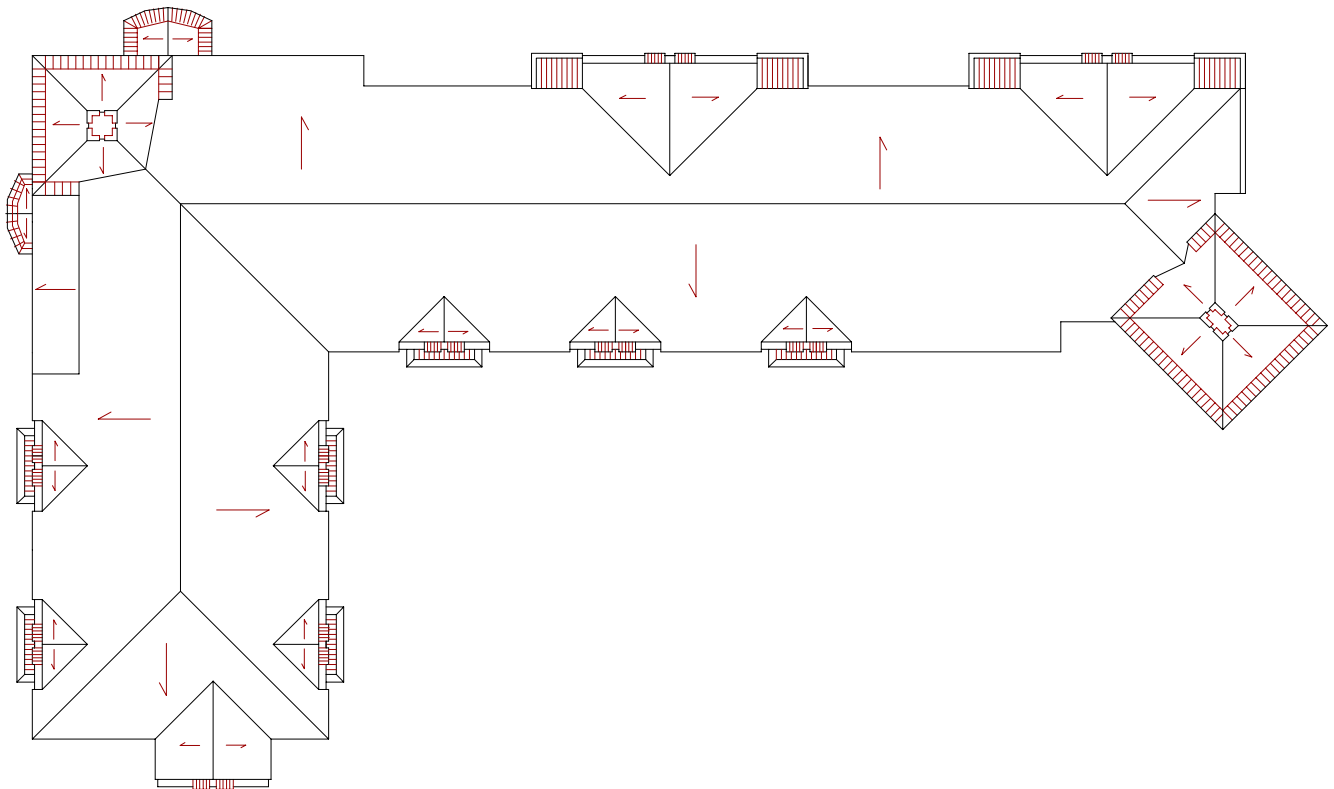

# Roof Corrective Action

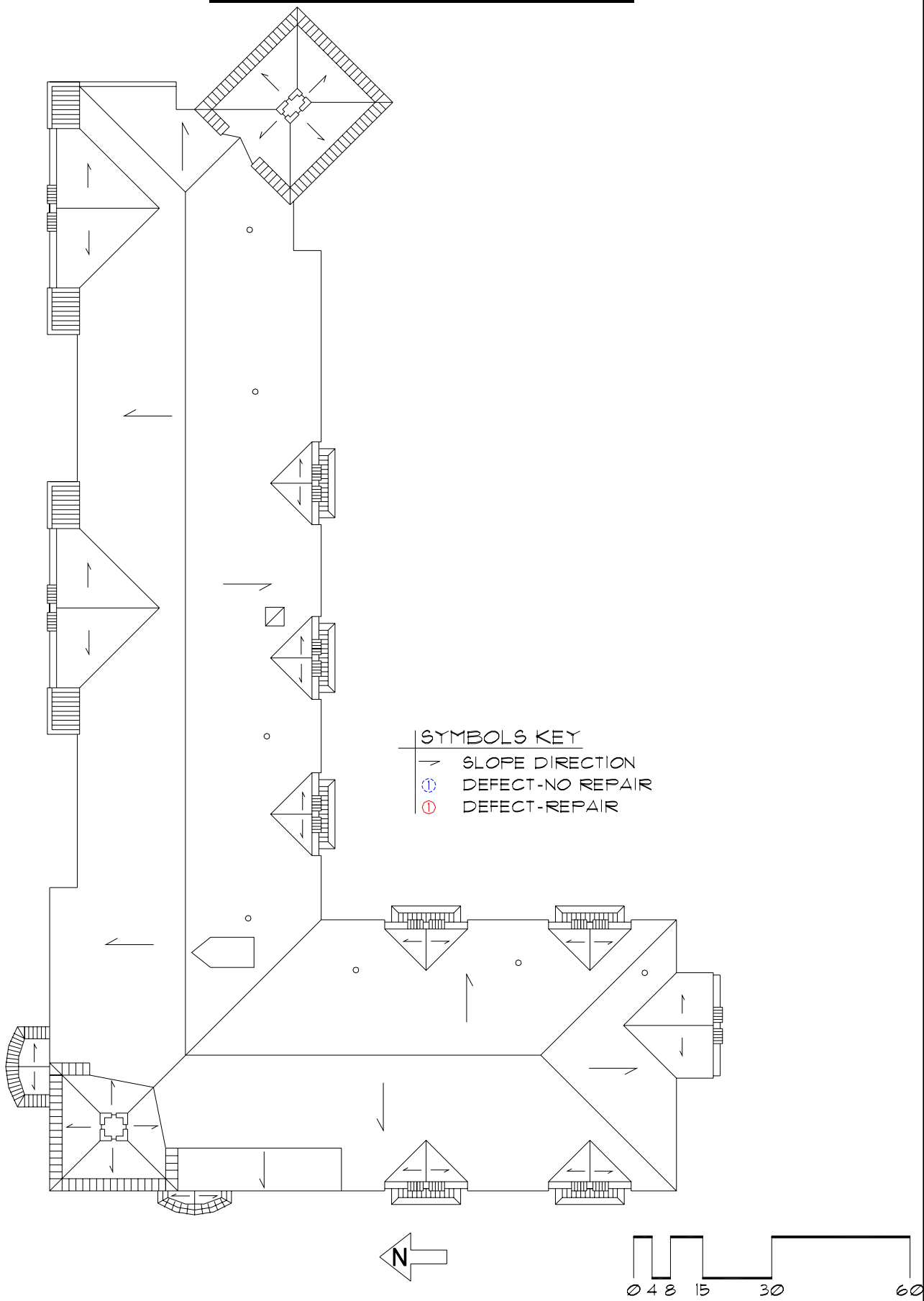

# Roof ID

Building: 105 - Territorial Hall - (417 Walnut St SE)

Total Area: 36,674 sf

<u>A</u>	<u>221 sf</u>	<u>E</u>	<u>81 sf</u>	<u>I</u>	<u>221 sf</u>
<u>B</u>	<u>16,835 sf</u>	<u>F</u>	<u>3,345 sf</u>	<u>J</u>	<u>264 sf</u>
<u>C</u>	<u>504 sf</u>	<u>G</u>	<u>8,400 sf</u>	<u>K</u>	<u>5,754 sf</u>
<u>D</u>	<u>620 sf</u>	<u>H</u>	<u>221 sf</u>	<u>L</u>	<u>208 sf</u>

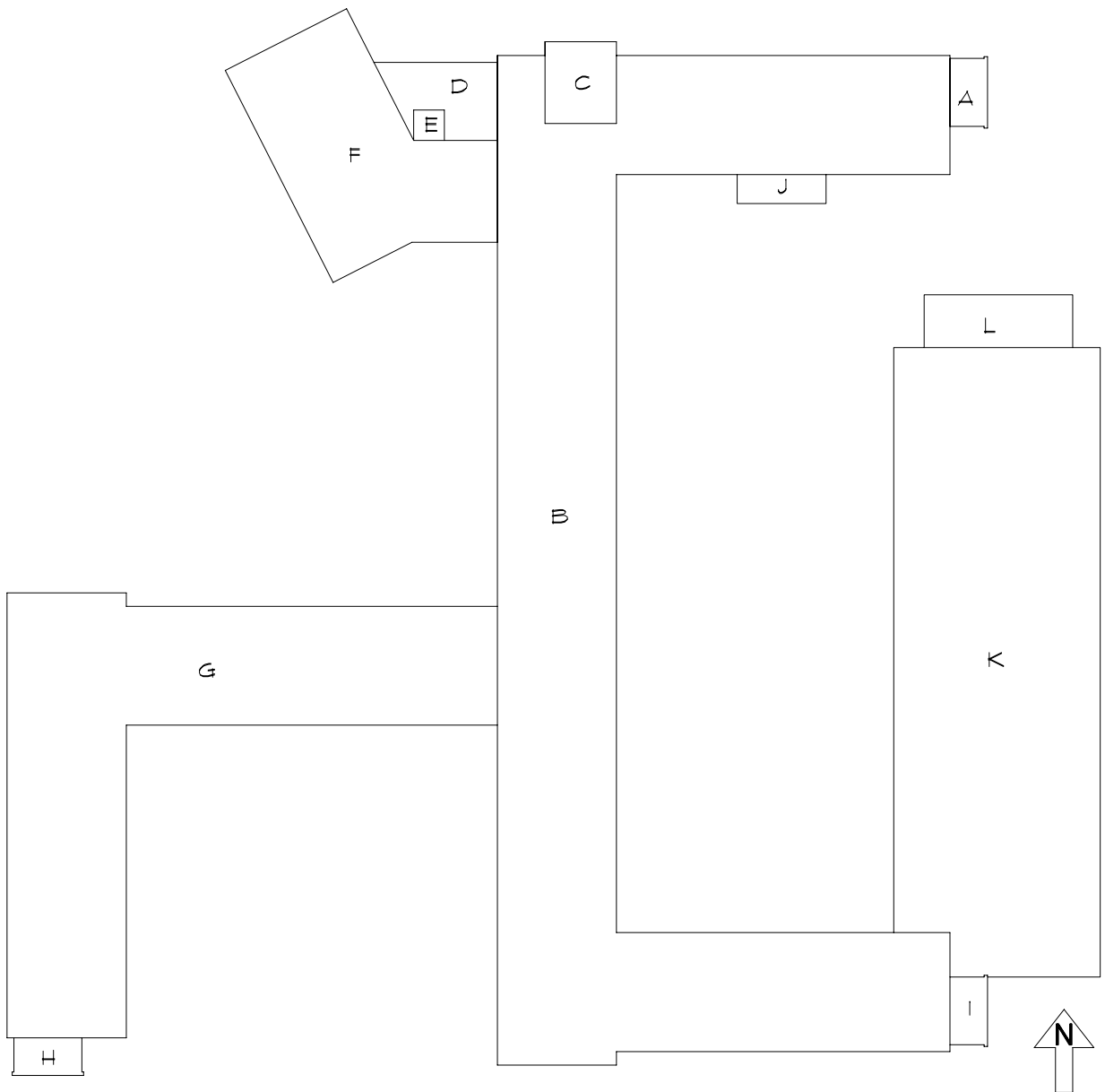

# Roof Corrective Action

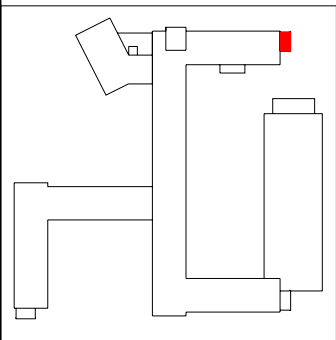
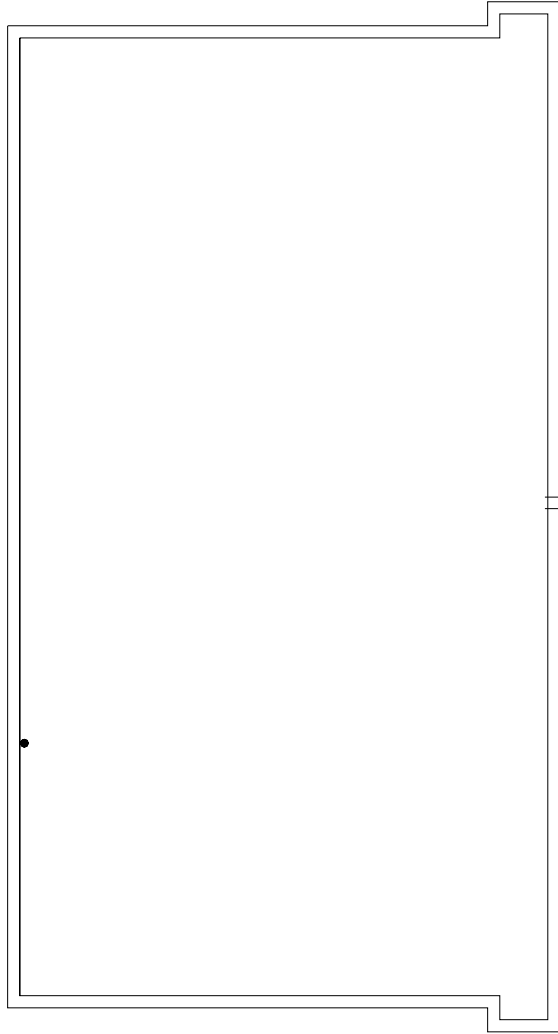

- SYMBOLS KEY**
- ROOF DRAIN
  - Ⓢ DEFECT-REPAIR
  - † SCUPPER

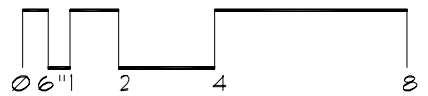

# Roof Corrective Action

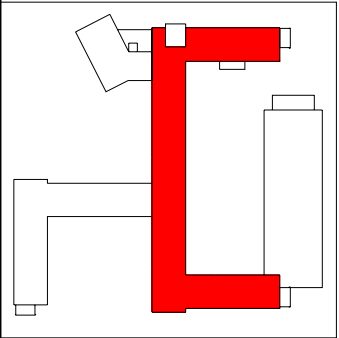
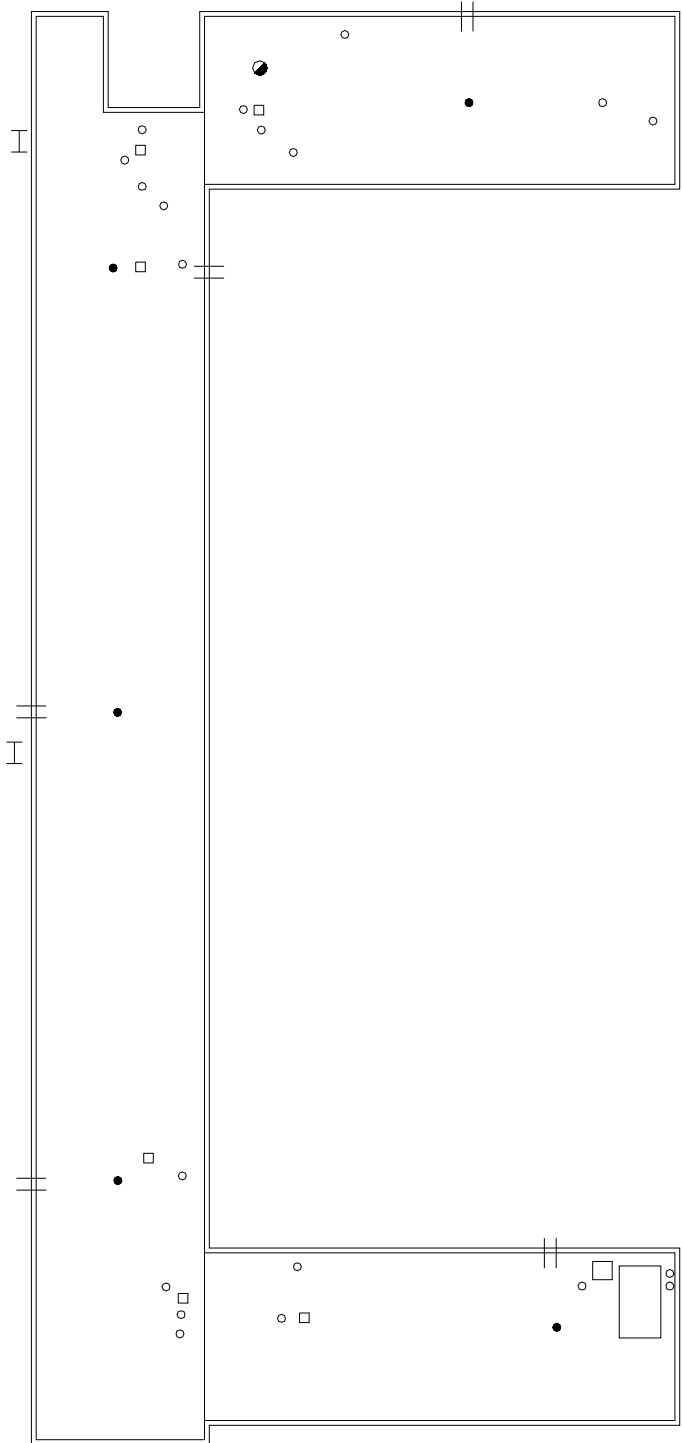

- SYMBOLS KEY**
- ROOF CURB
  - ROOF DRAIN
  - VENT STACK
  - HEAT STACK
  - ≡ SCUPPER
  - I LADDER

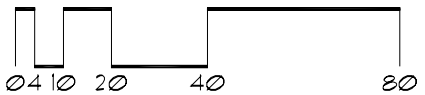

# Roof Corrective Action

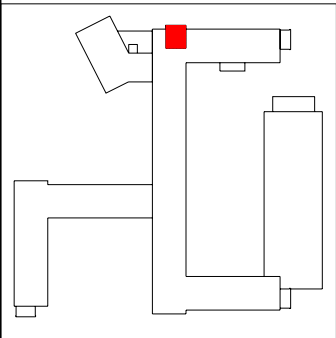
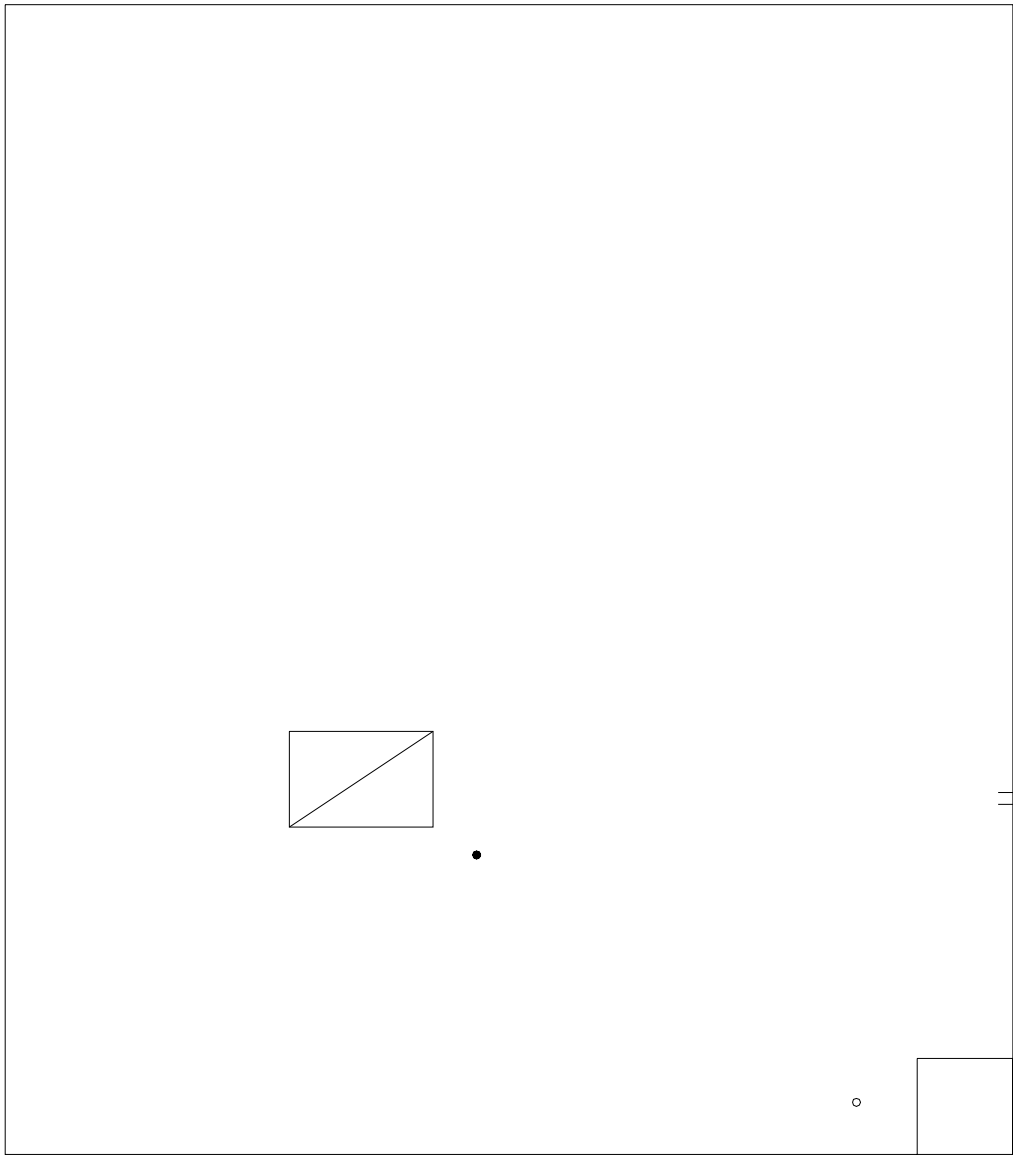

### SYMBOLS KEY

- ROOF CURB
- ROOF DRAIN
- ≡ SCUPPER
- ◻ ROOF HATCH
- Ⓢ DEFECT-REPAIR

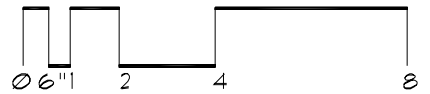

# Roof Corrective Action

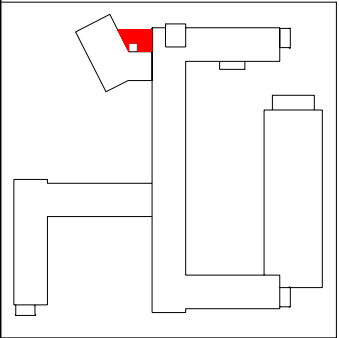
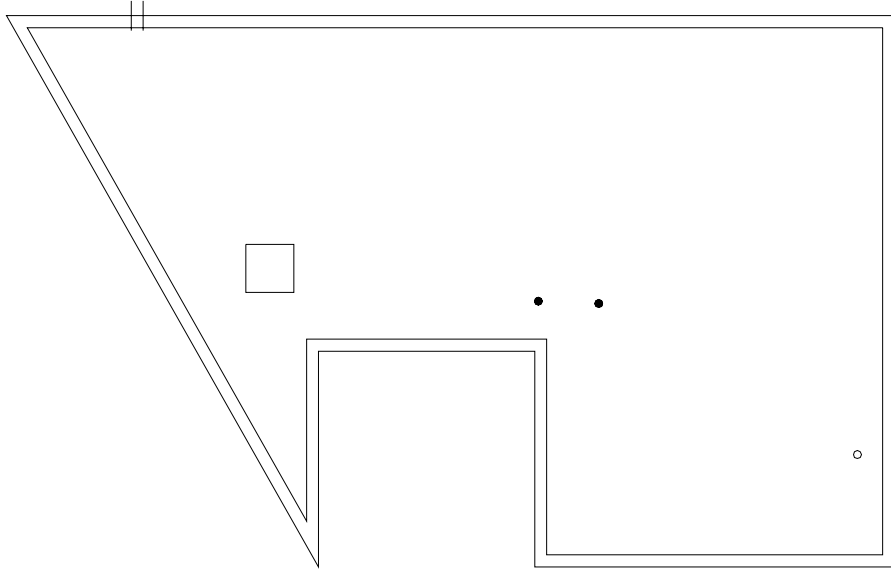

- SYMBOLS KEY**
- ROOF CURB
  - ROOF DRAIN
  - †† SCUPPER
  - VENT STACK

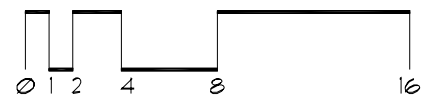

# Roof Corrective Action

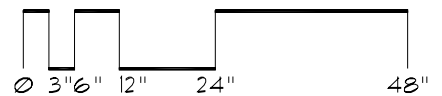
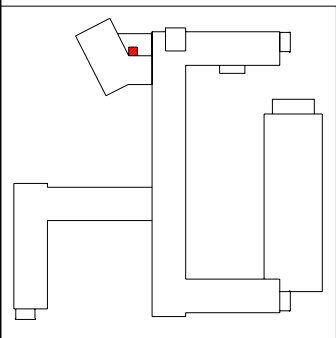
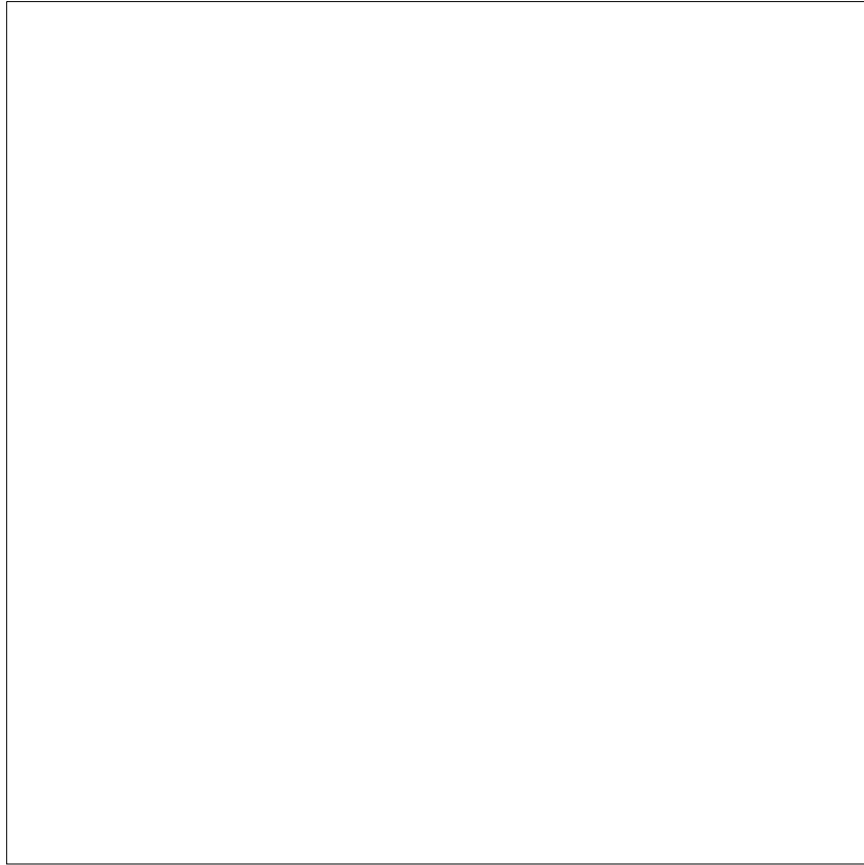



# Roof Corrective Action

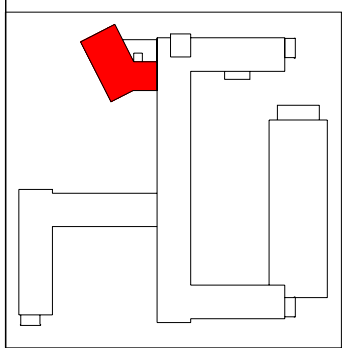
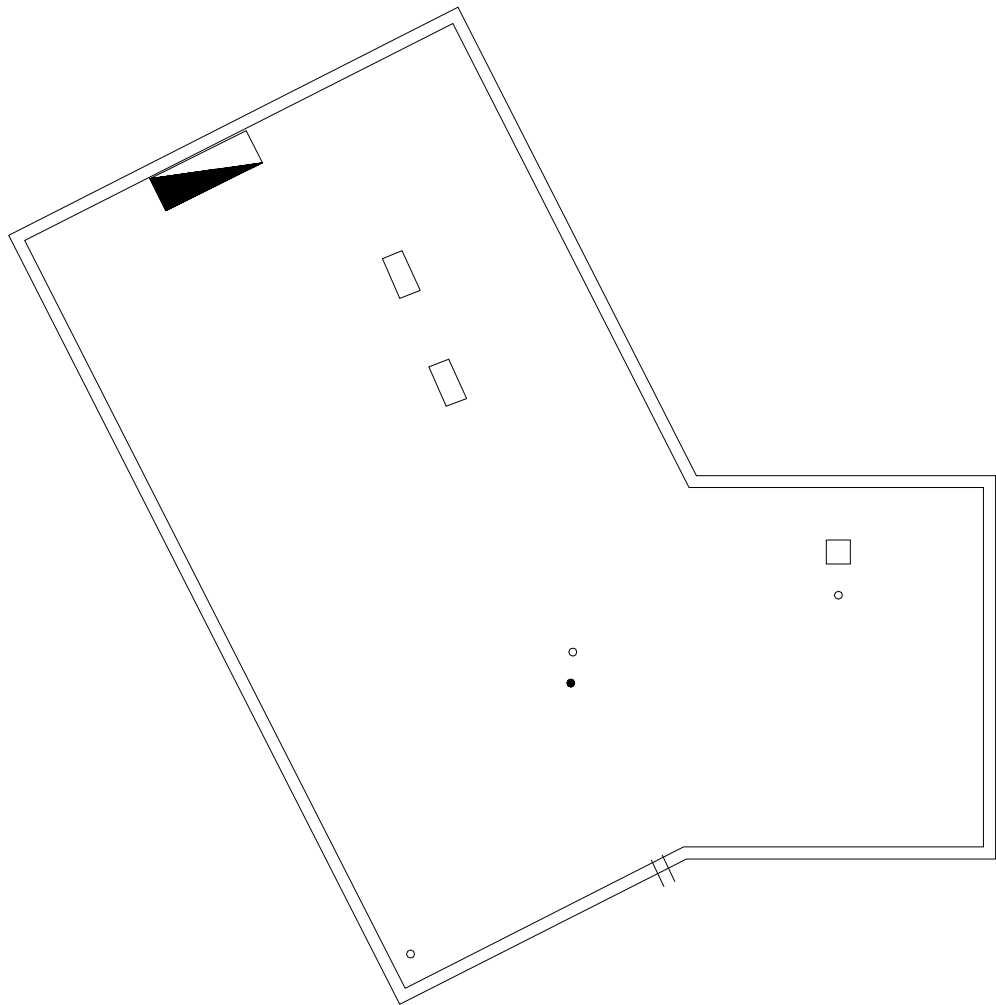

- SYMBOLS KEY**
- ROOF CURB
  - ROOF DRAIN
  - VENT STACK
  - ▀ CHIMNEY
  - ≡ SCUPPER
  - Ⓢ DEFECT-REPAIR
  - Ⓣ DEFECT-NO REPAIR



# Roof Corrective Action

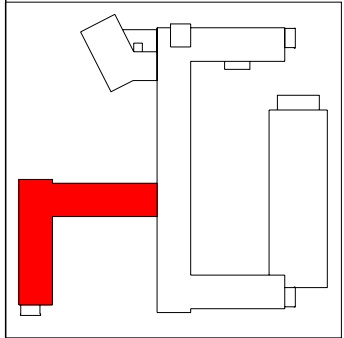
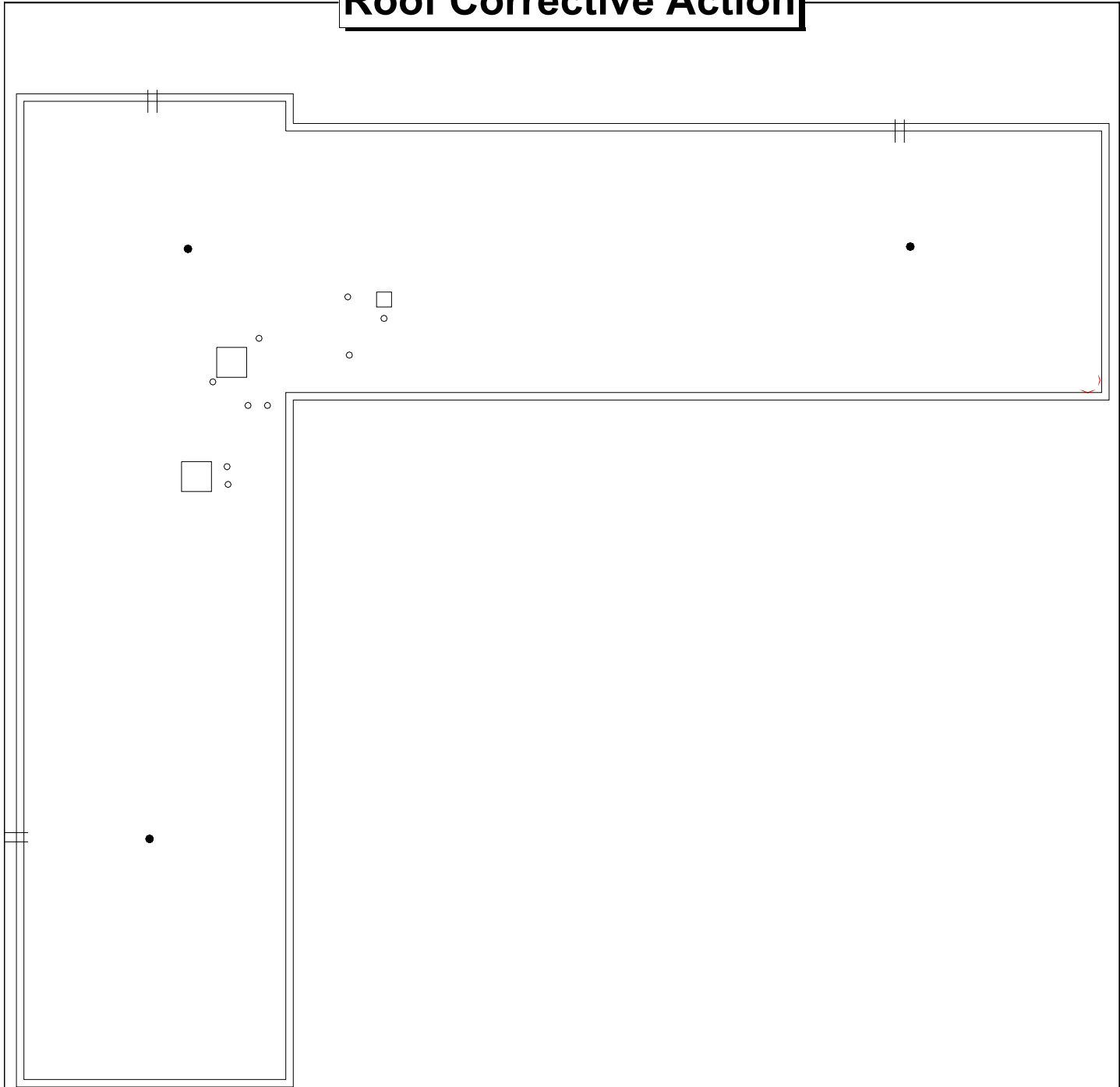

- SYMBOLS KEY**
- ROOF CURB
  - ROOF DRAIN
  - VENT STACK
  - † SCUPPER
  - ① DEFECT-REPAIR

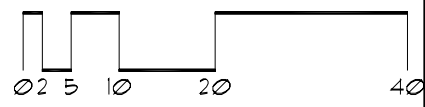
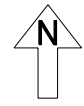

# Roof Corrective Action

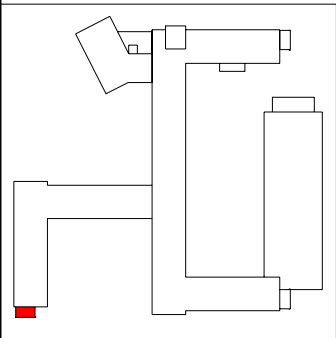
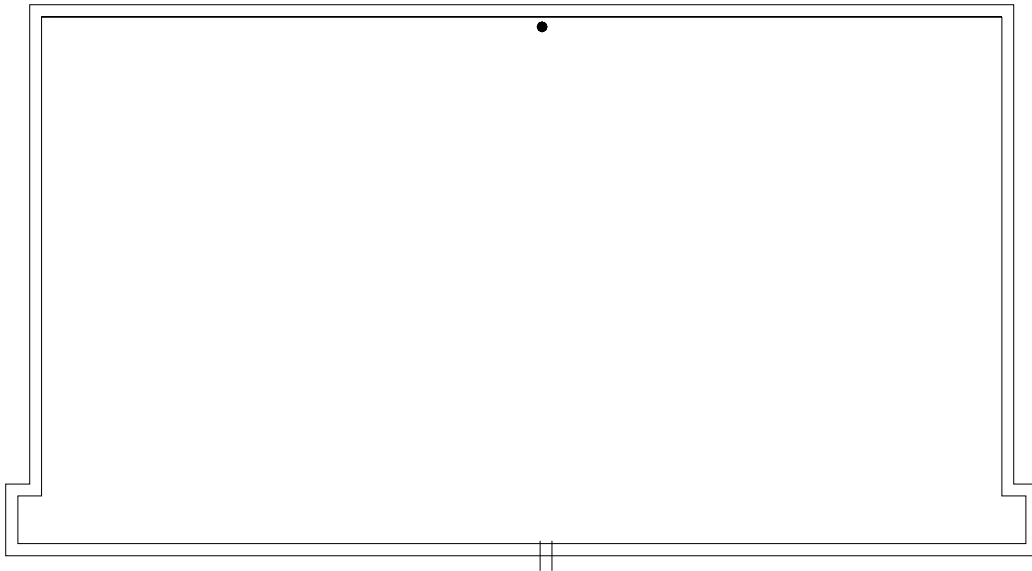

SYMBOLS KEY  
• ROOF DRAIN  
|| SCUPPER

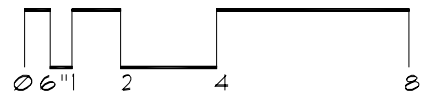

# Roof Corrective Action

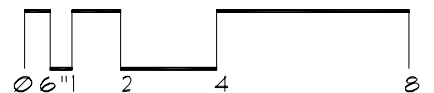
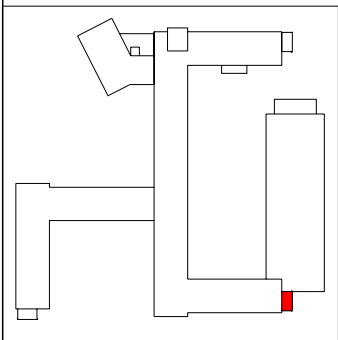
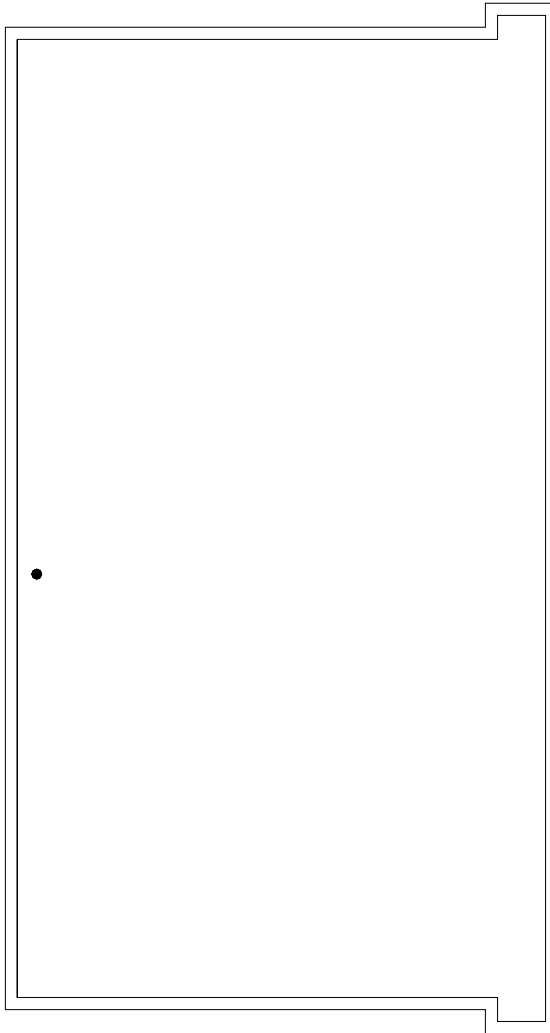

# Roof Corrective Action

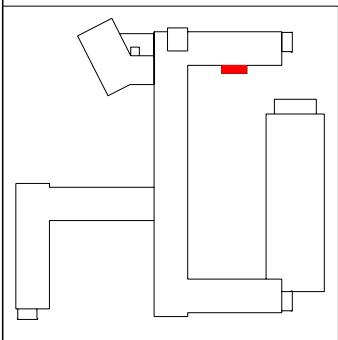
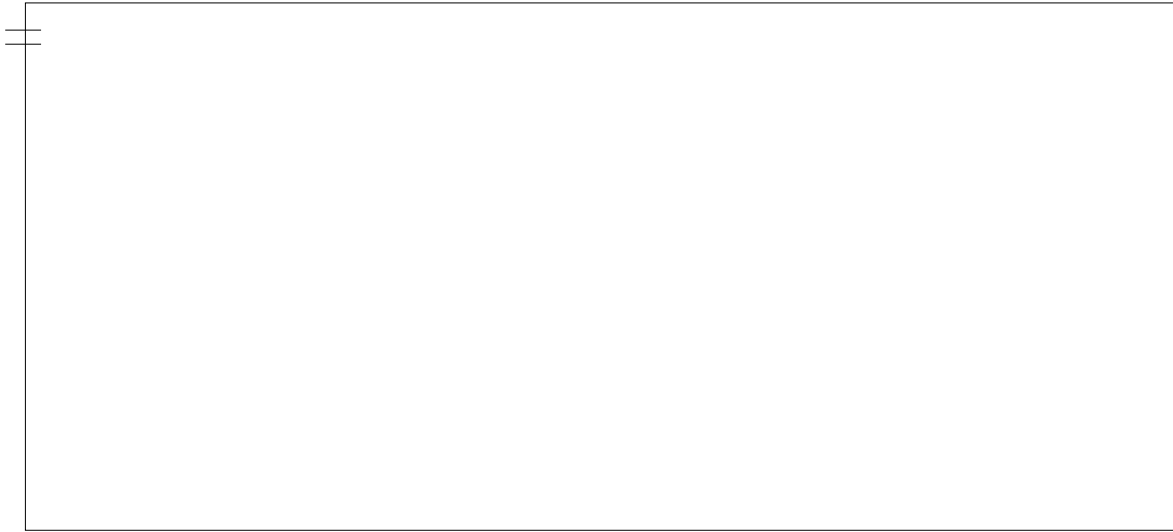

SYMBOLS KEY  
|| SCUPPER

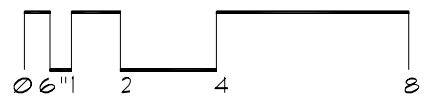

# Roof Corrective Action

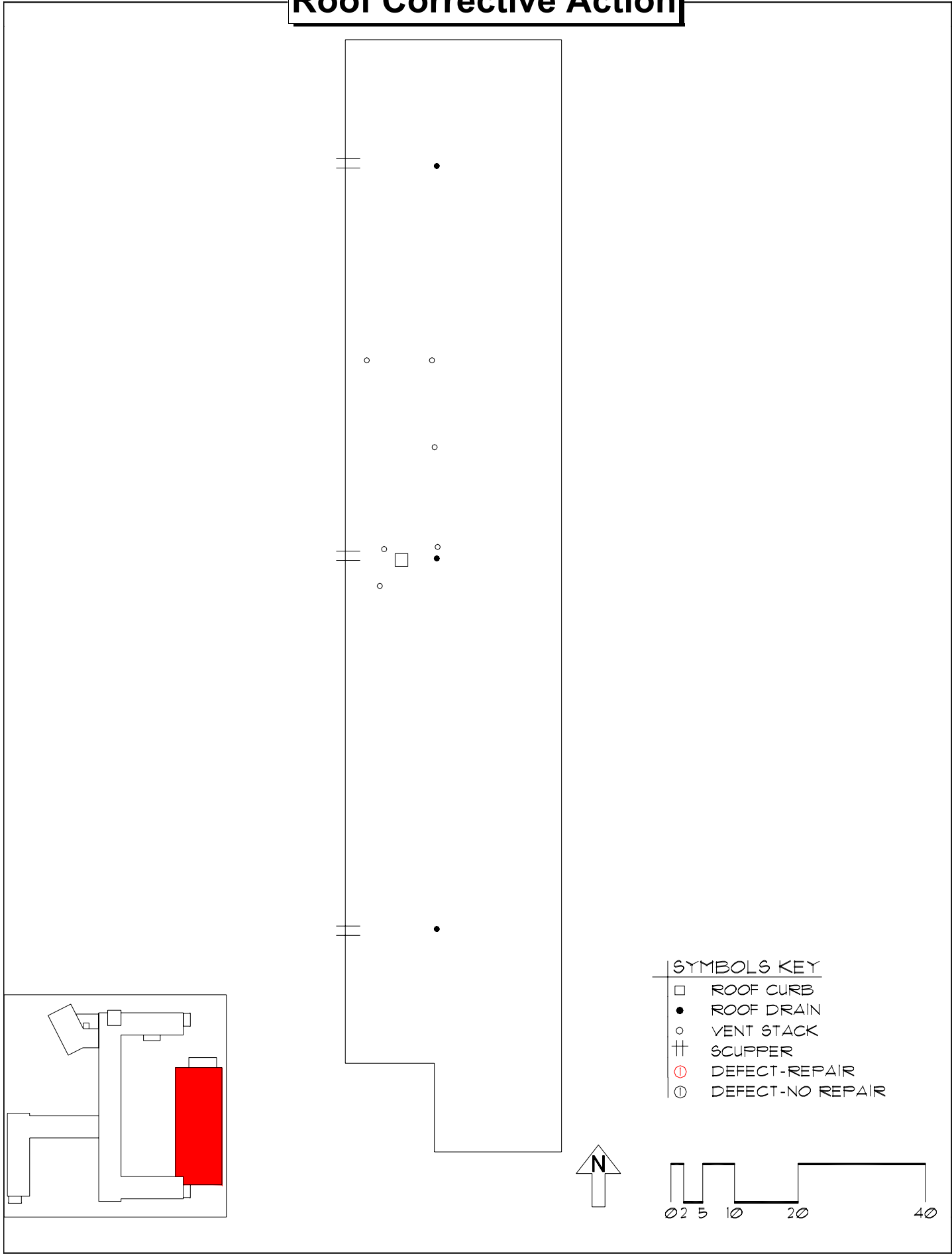

## SYMBOLS KEY

- ROOF CURB
- ROOF DRAIN
- VENT STACK
- ⊕ SCUPPER
- Ⓡ DEFECT-REPAIR
- Ⓢ DEFECT-NO REPAIR

# Roof Corrective Action

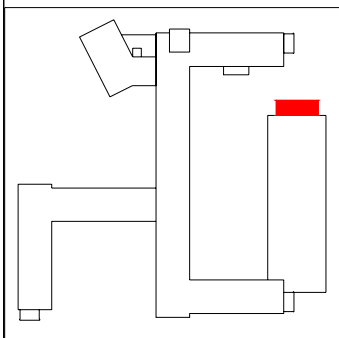
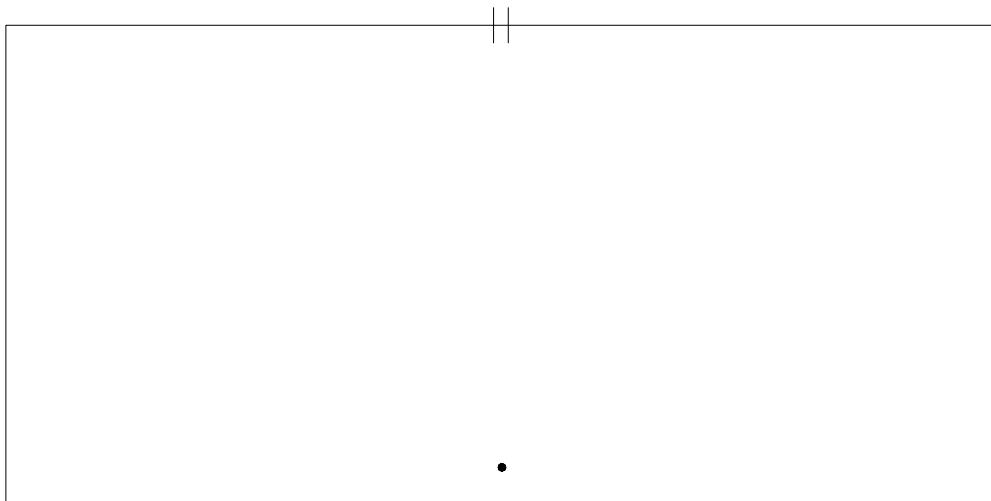

SYMBOLS KEY  
• ROOF DRAIN  
|| SCUPPER

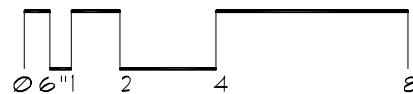

# Roof ID

**Building:** 189 - Yudof Hall - ()

**Total Area:** 26,474 sf

<b>A</b>	13,600 sf	<b>E</b>	575 sf	<b>I</b>	1,640 sf	<b>M</b>	560 sf
<b>B</b>	3,566 sf	<b>F</b>	568 sf	<b>J</b>	525 sf		
<b>C</b>	800 sf	<b>G</b>	1,630 sf	<b>K</b>	830 sf		
<b>D</b>	1,125 sf	<b>H</b>	530 sf	<b>L</b>	525 sf		

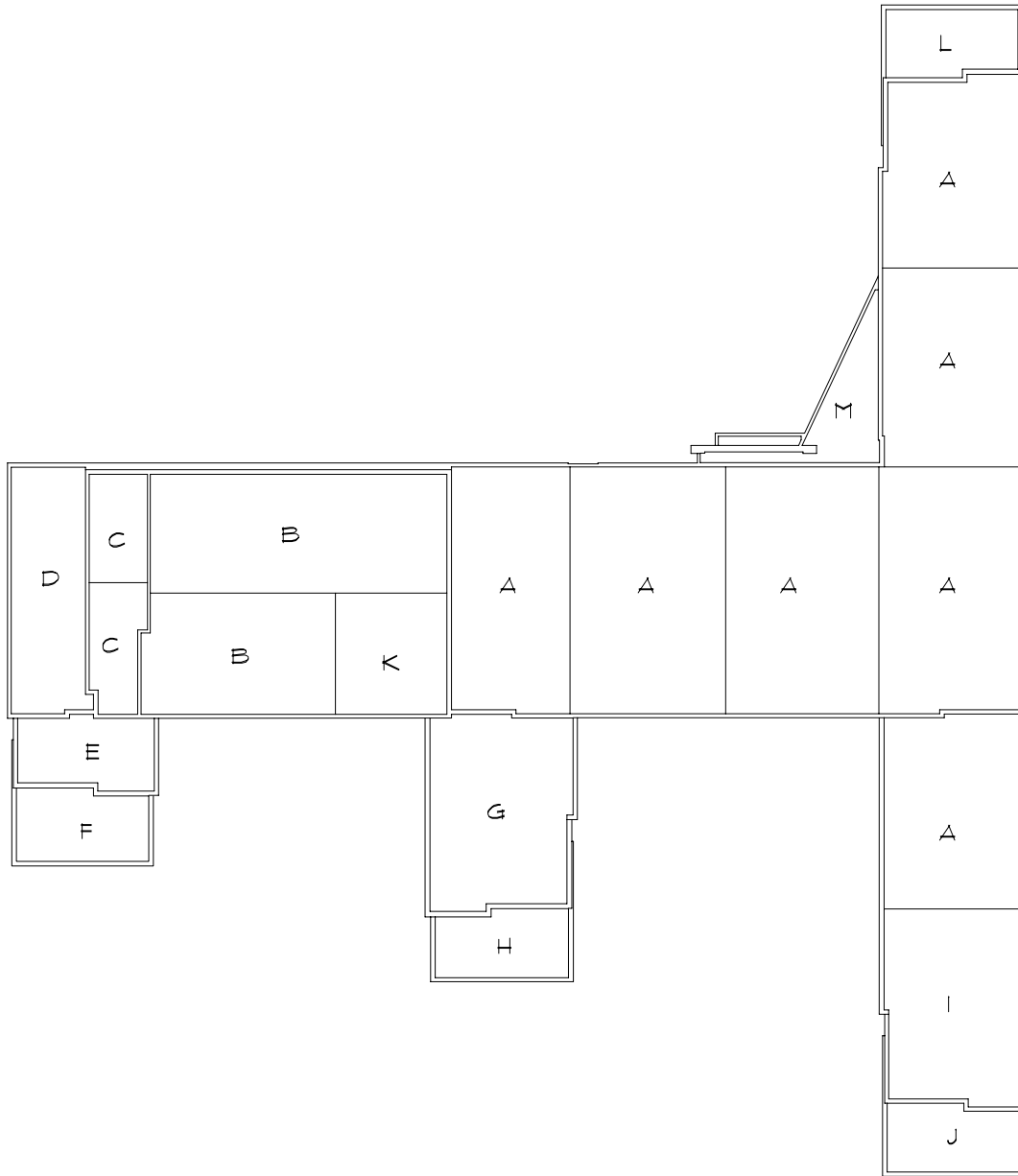



# Roof Corrective Action

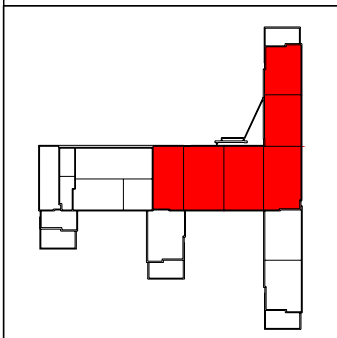
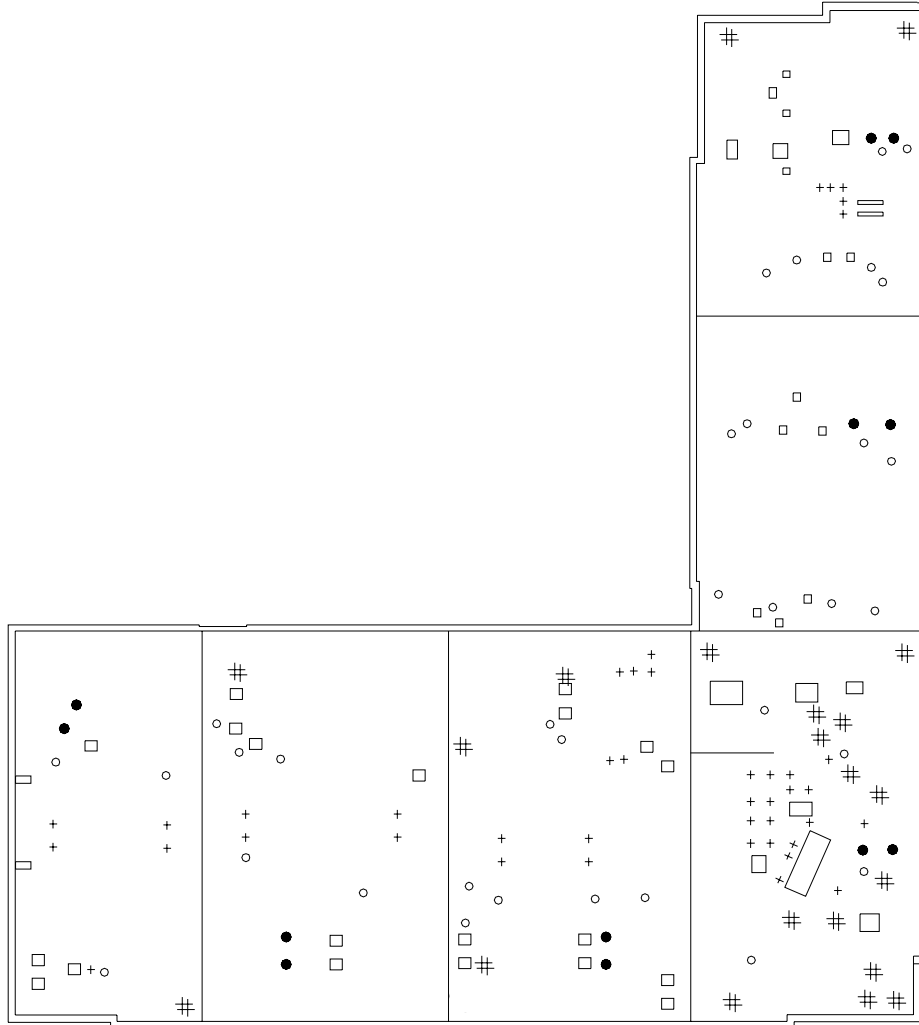

## SYMBOLS KEY

- ROOF CURB
- VENT STACK
- ROOF DRAIN
- + FLASHED PENETRATION
- Ⓢ DEFECT-REPAIR
- Ⓢ DEFECT-NO REPAIR

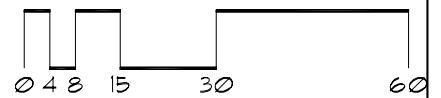

# Roof Corrective Action

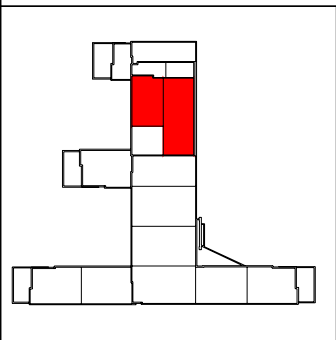
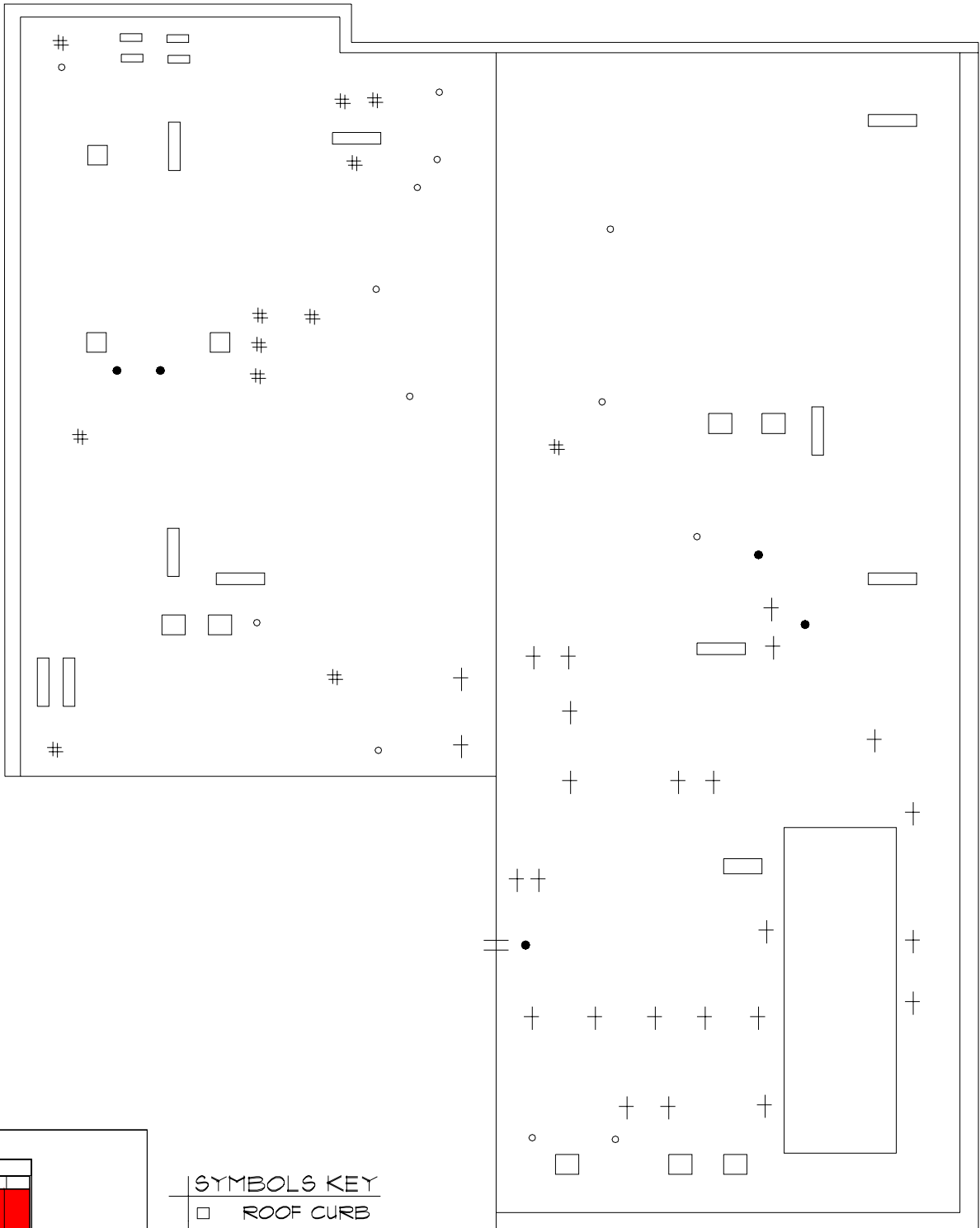

- SYMBOLS KEY**
- ROOF CURB
  - ROOF CURB
  - ROOF DRAIN
  - VENT STACK
  - ⊕ PIPE PENETRATION
  - # PITCH PAN
  - ⓪ DEFECT-NO REPAIR

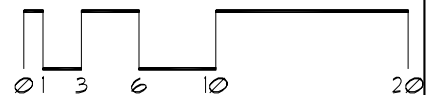

# Roof Corrective Action

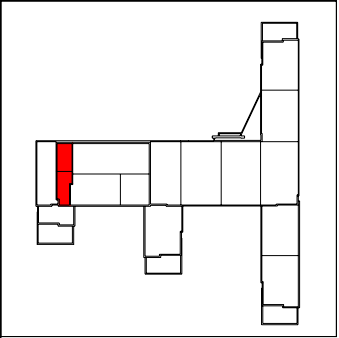
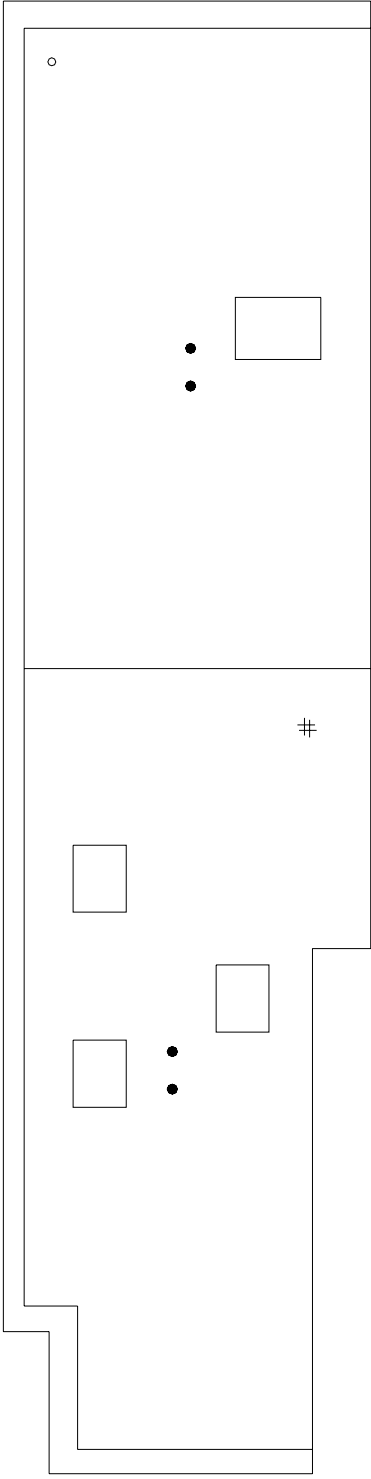

### SYMBOLS KEY

- ROOF CURB
- ROOF DRAIN
- # PITCH PAN
- VENT STACK
- Ⓜ DEFECT-REPAIR

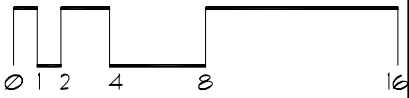

# Roof Corrective Action

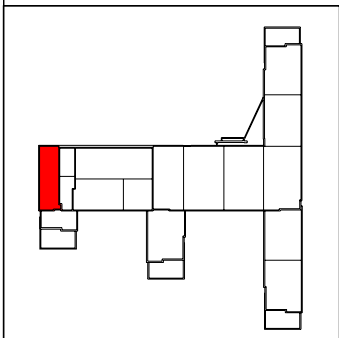
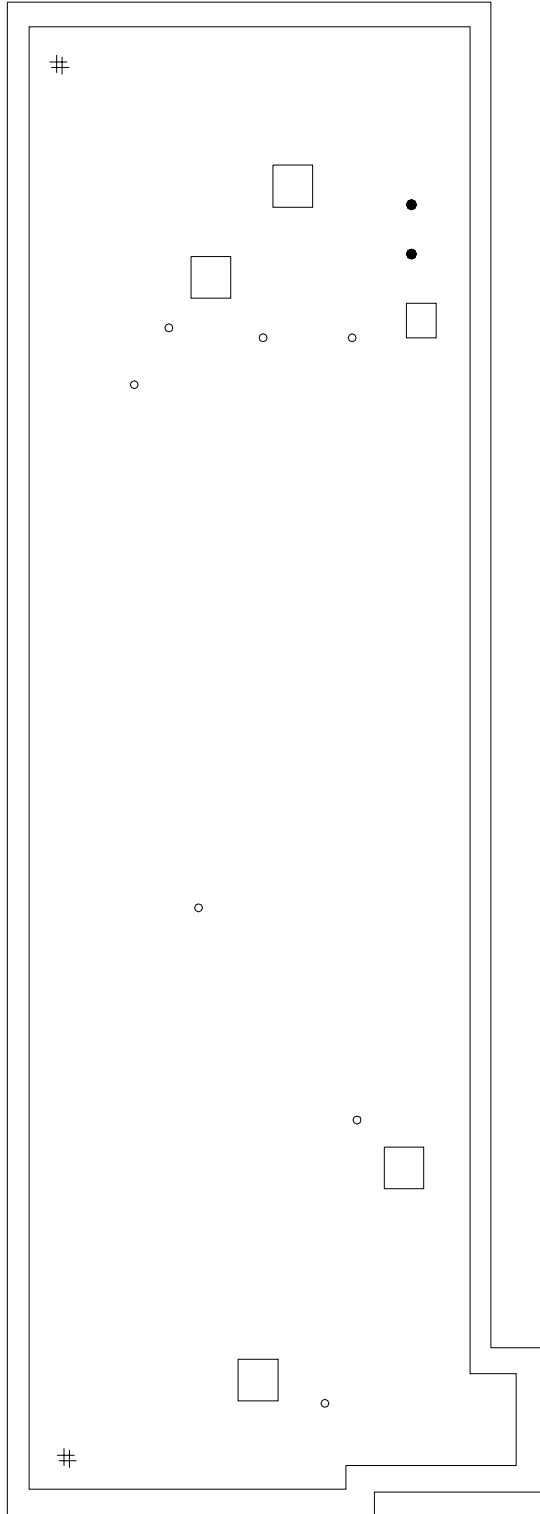

- SYMBOLS KEY**
- ROOF CURB
  - ROOF DRAIN
  - VENT STACK
  - # PITCH PAN
  - Ⓢ DEFECT-REPAIR

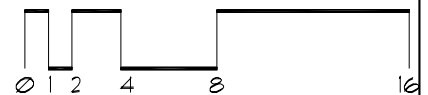

# Roof Corrective Action

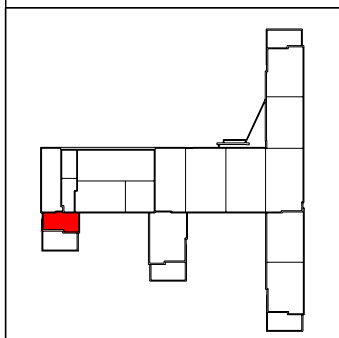
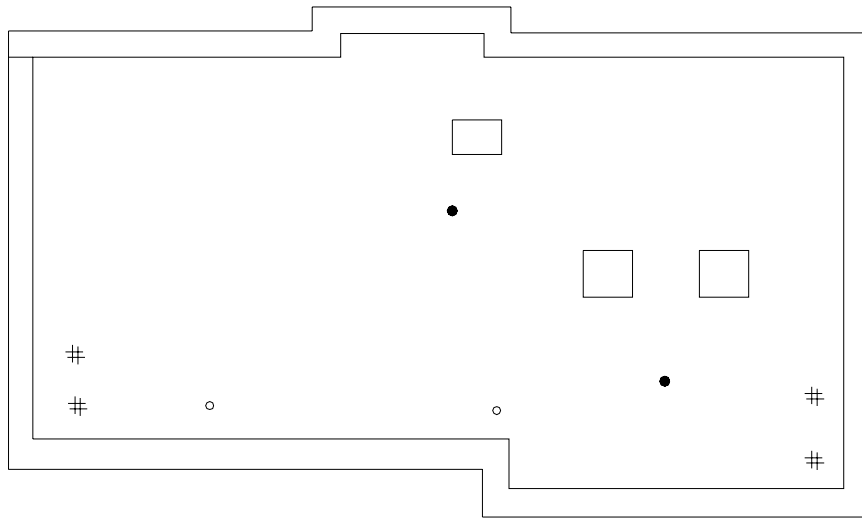

## SYMBOLS KEY

- ROOF CURB
- ROOF DRAIN
- VENT STACK
- # PITCH PAN
- Ⓢ DEFECT-REPAIR

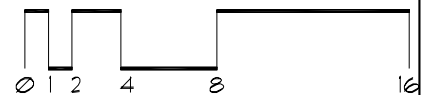

# Roof Corrective Action

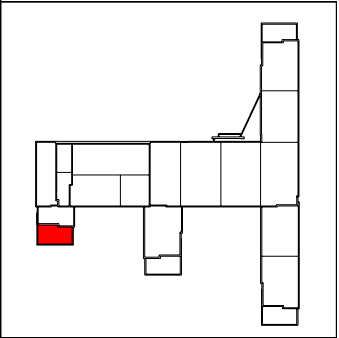
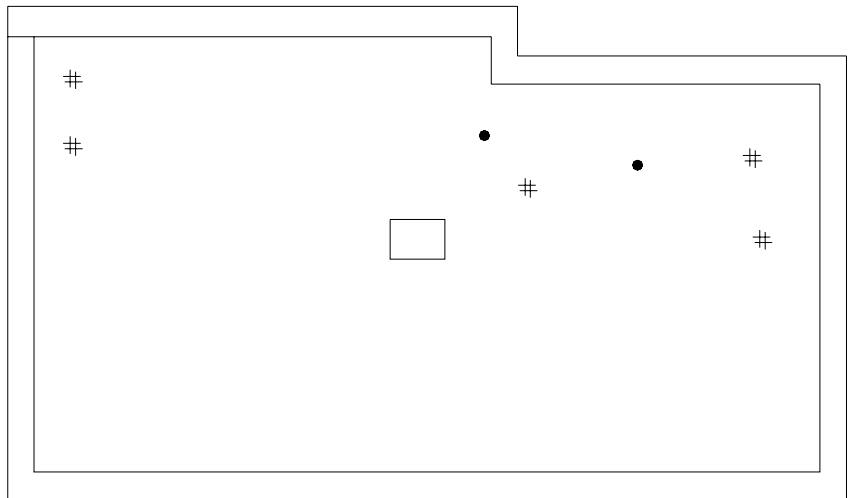

- SYMBOLS KEY
- ROOF CURB
  - ROOF DRAIN
  - # PITCH PAN
  - ⊖ DEFECT-NO REPAIR

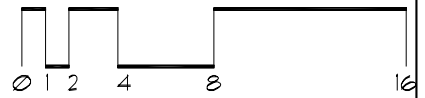

# Roof Corrective Action

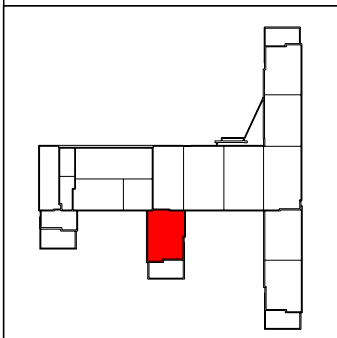
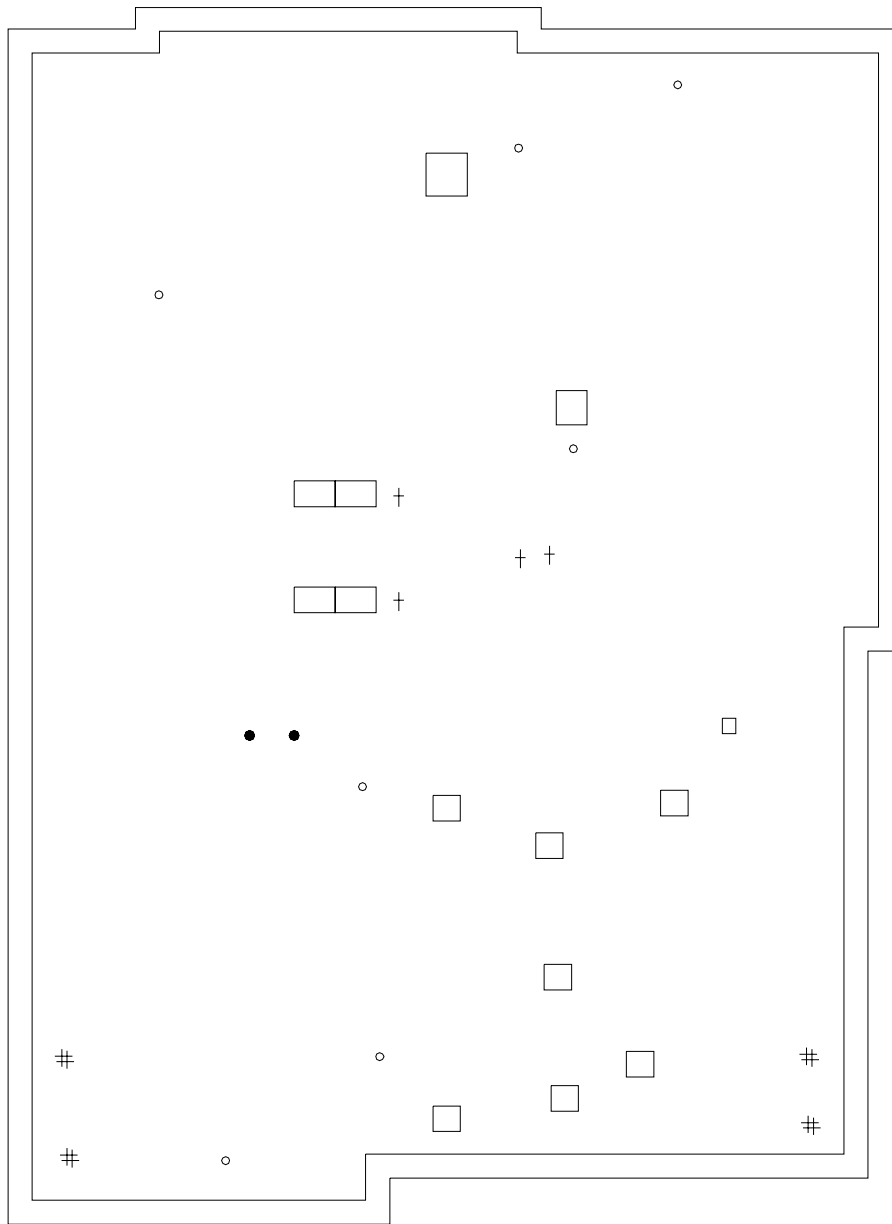

## SYMBOLS KEY

- ROOF CURB
- ROOF DRAIN
- VENT STACK
- # PITCH PAN
- Ⓢ DEFECT-REPAIR
- + FLASHED PENETRATION

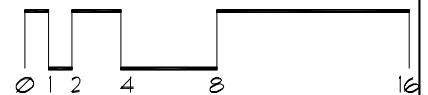

# Roof Corrective Action

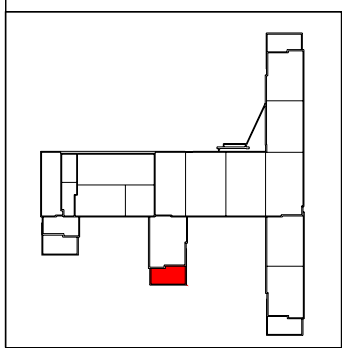
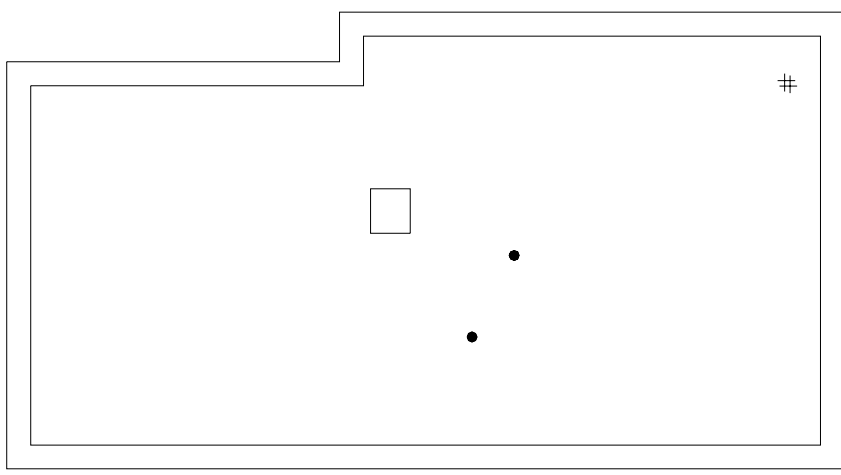

- SYMBOLS KEY
- ROOF CURB
  - ROOF DRAIN
  - # PITCH PAN

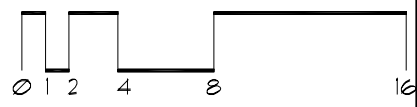



# Roof Corrective Action

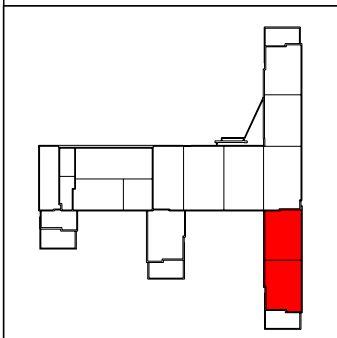
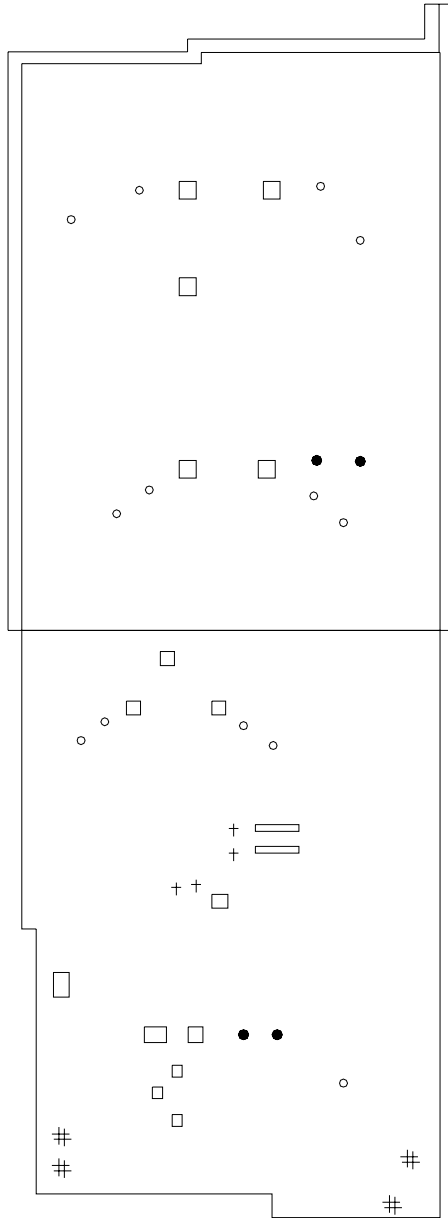

## SYMBOLS KEY

- ROOF CURB
- + FLASHED PENETRATION
- ROOF DRAIN
- VENT STACK
- # PITCH PAN
- ⊖ DEFECT-REPAIR
- ≡ SLEEPER CURB

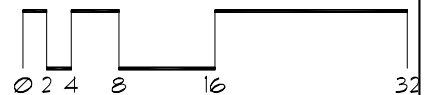

# Roof Corrective Action

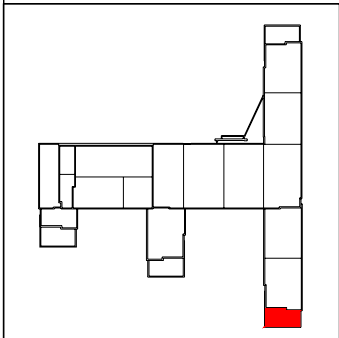
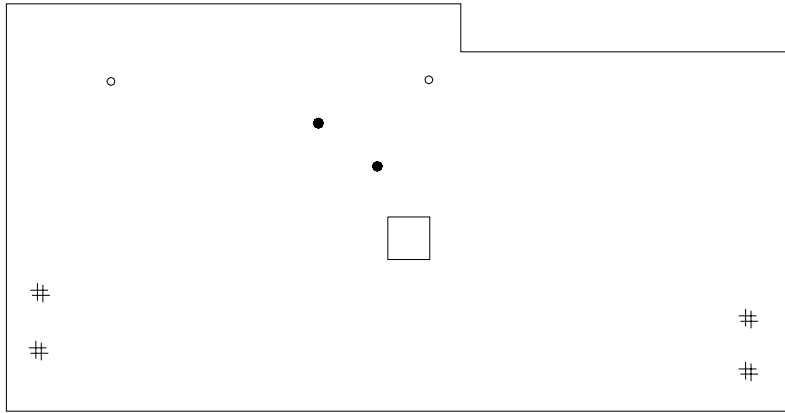

## SYMBOLS KEY

- ROOF CURB
- ROOF DRAIN
- VENT STACK
- # PITCH PAN

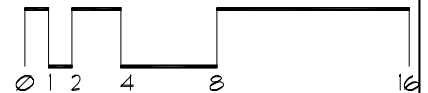

# Roof Corrective Action

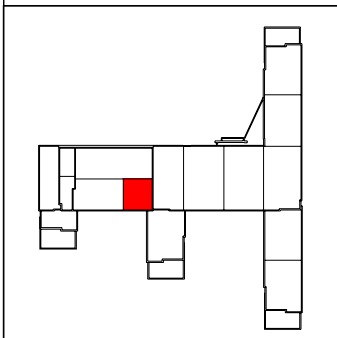
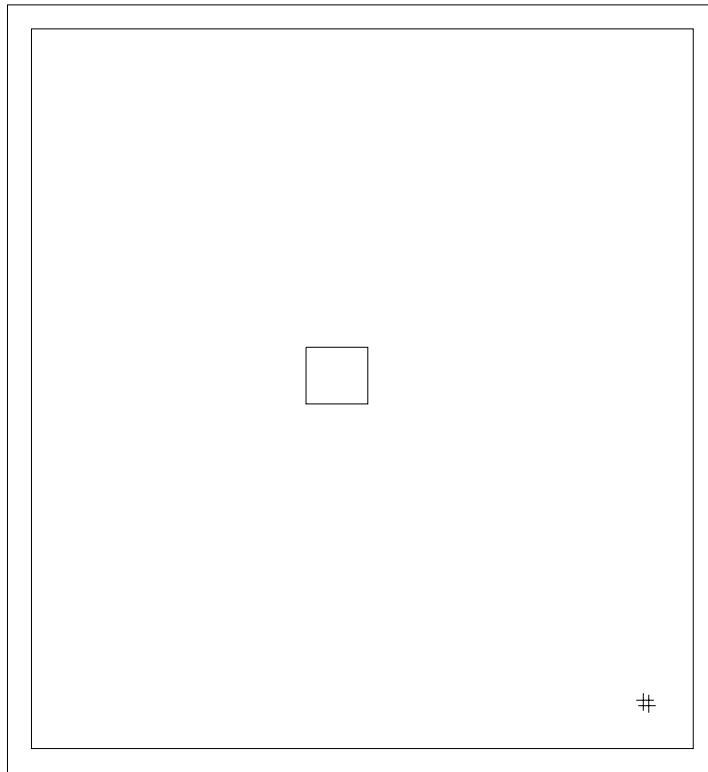

SYMBOLS KEY  
□ ROOF CURB  
# PITCH PAN

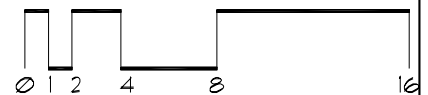

# Roof Corrective Action

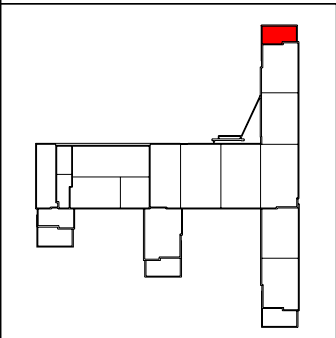
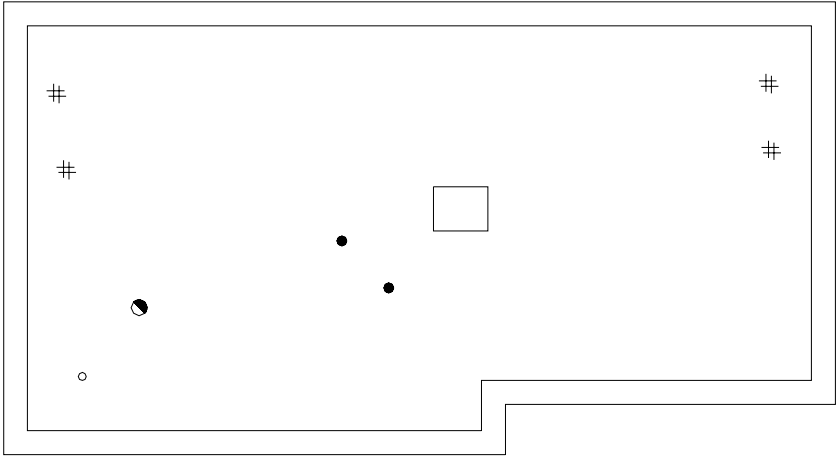

## SYMBOLS KEY

- ROOF CURB
- ROOF DRAIN
- VENT STACK
- # PITCH PAN
- ⓪ DEFECT-NO REPAIR

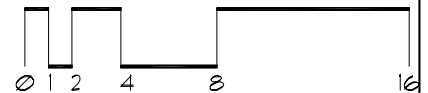

# Roof Corrective Action

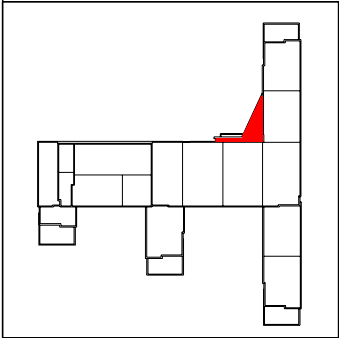
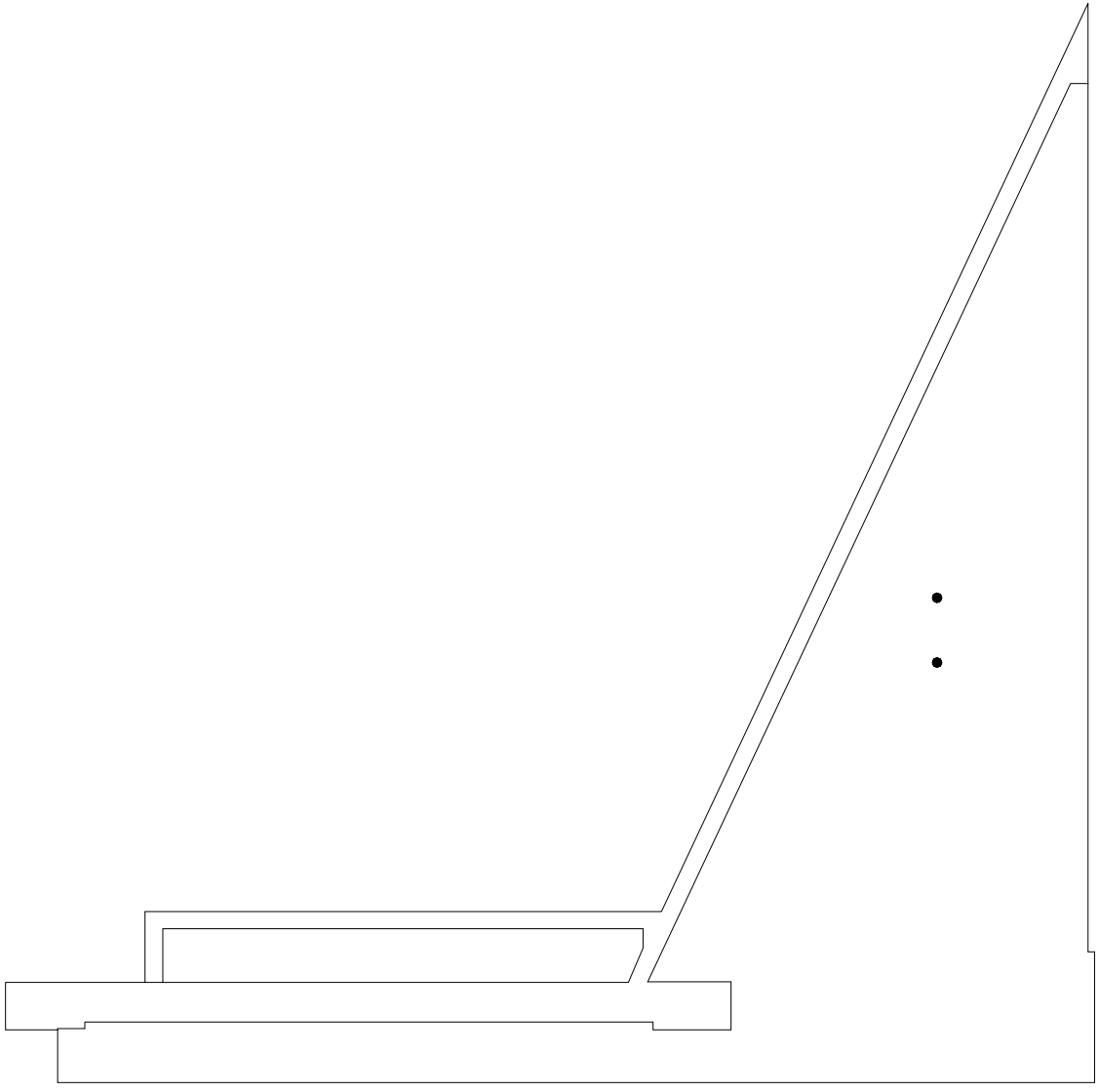

SYMBOLS KEY  
• ROOF DRAIN

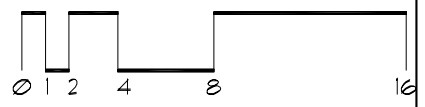

# Roof ID

Building: 01 - CT-01 - ()

Total Area: 2,650 sf

A 2,650 sf

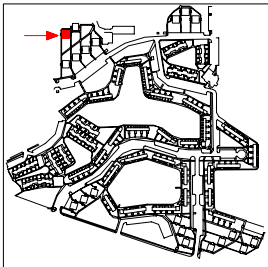
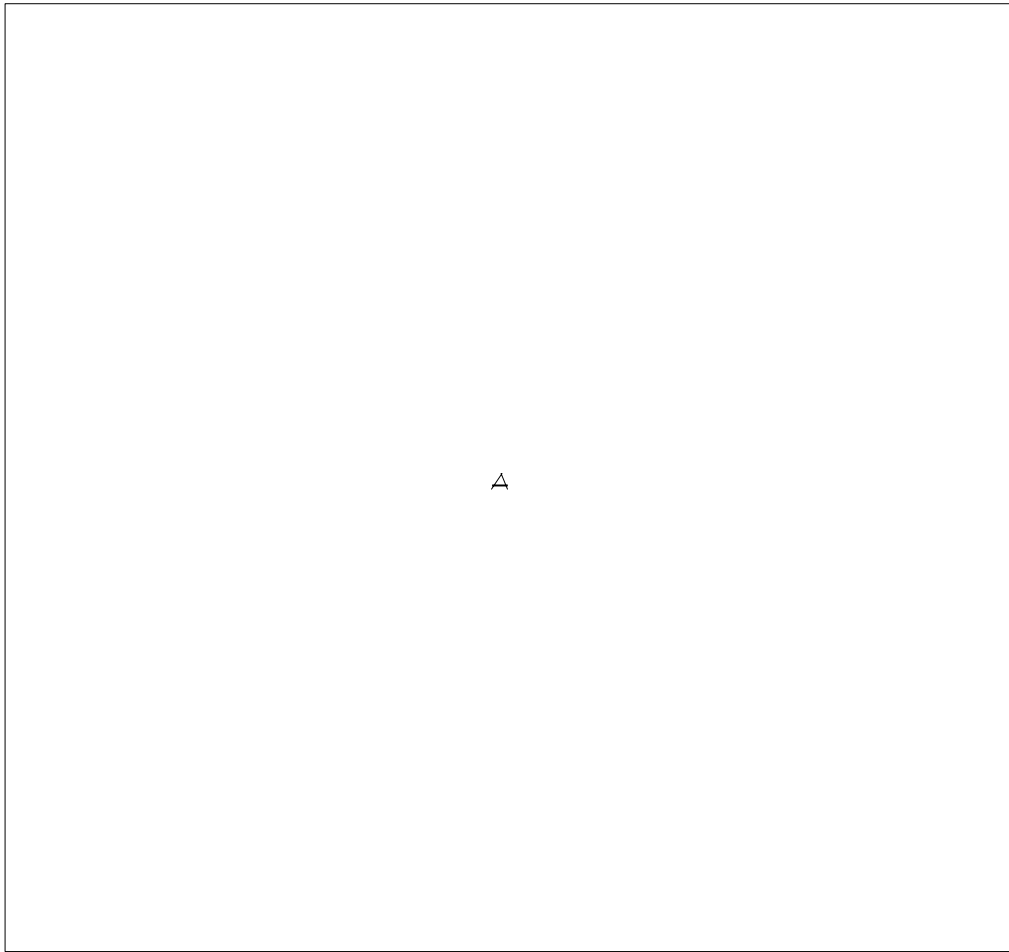

# Roof Corrective Action

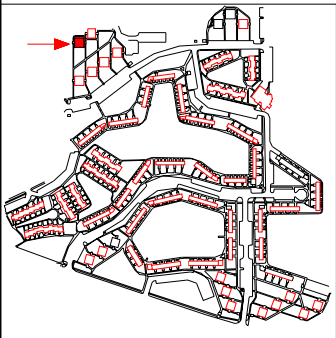
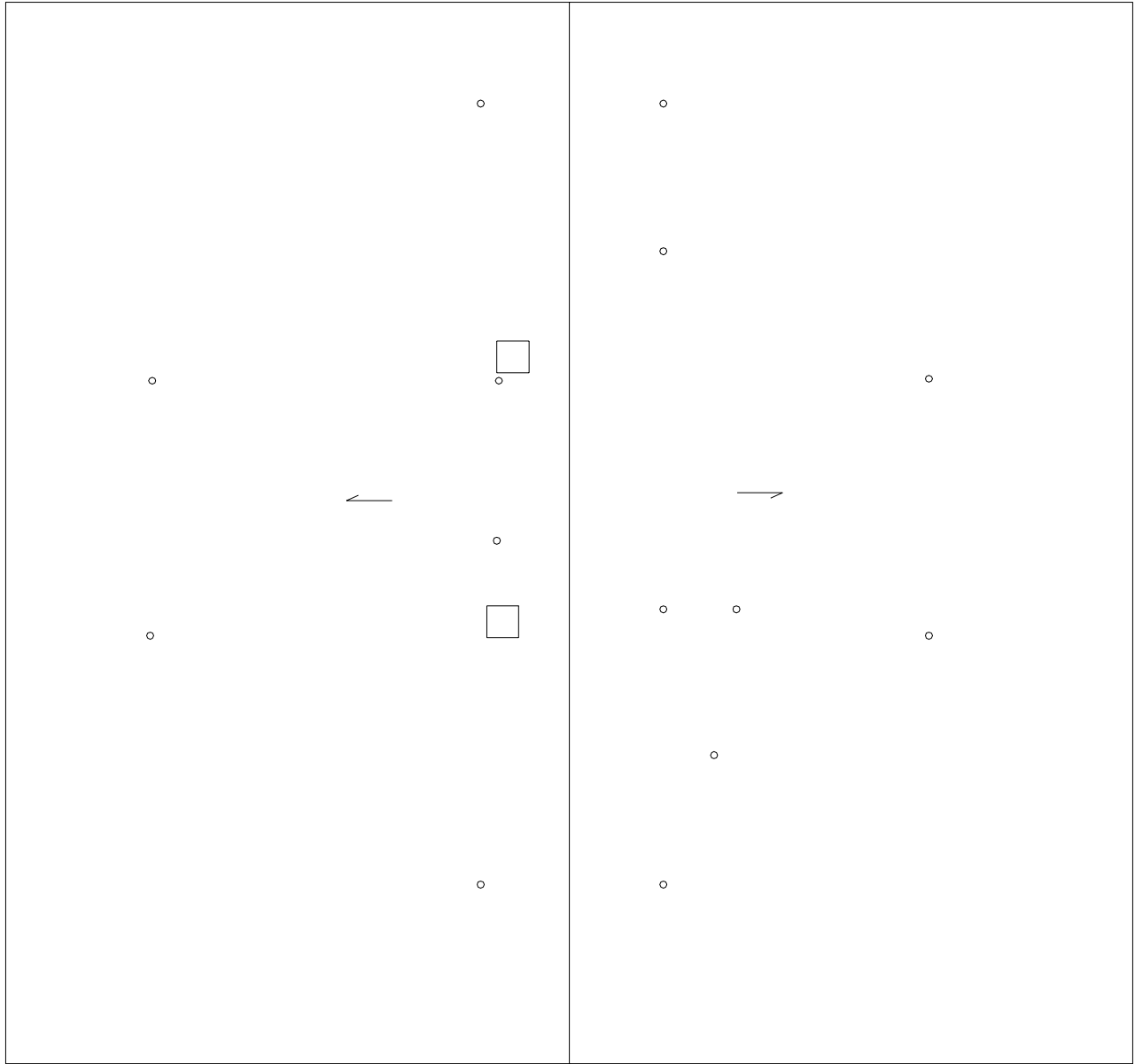

**SYMBOLS KEY**

- ROOF CURB
- VENT STACK
- SLOPE DIRECTION
- Ⓜ DEFECT-REPAIR

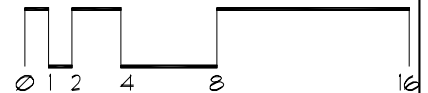

# Roof ID

Building: 02 - CT-02 - ()

Total Area: 2,650 sf

A 2,650 sf

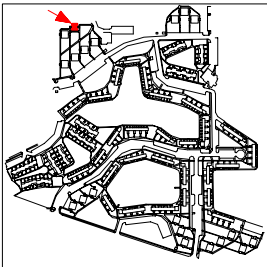
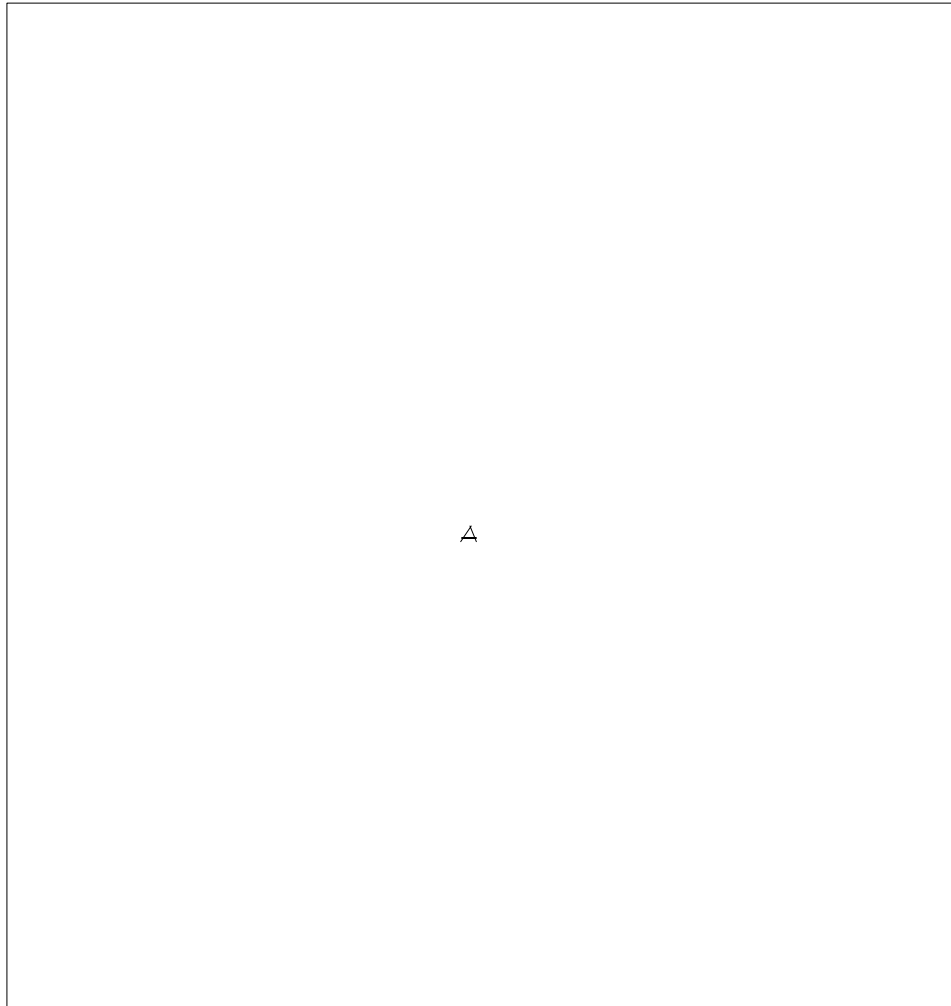



# Roof Corrective Action

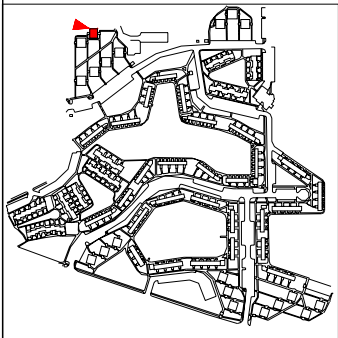
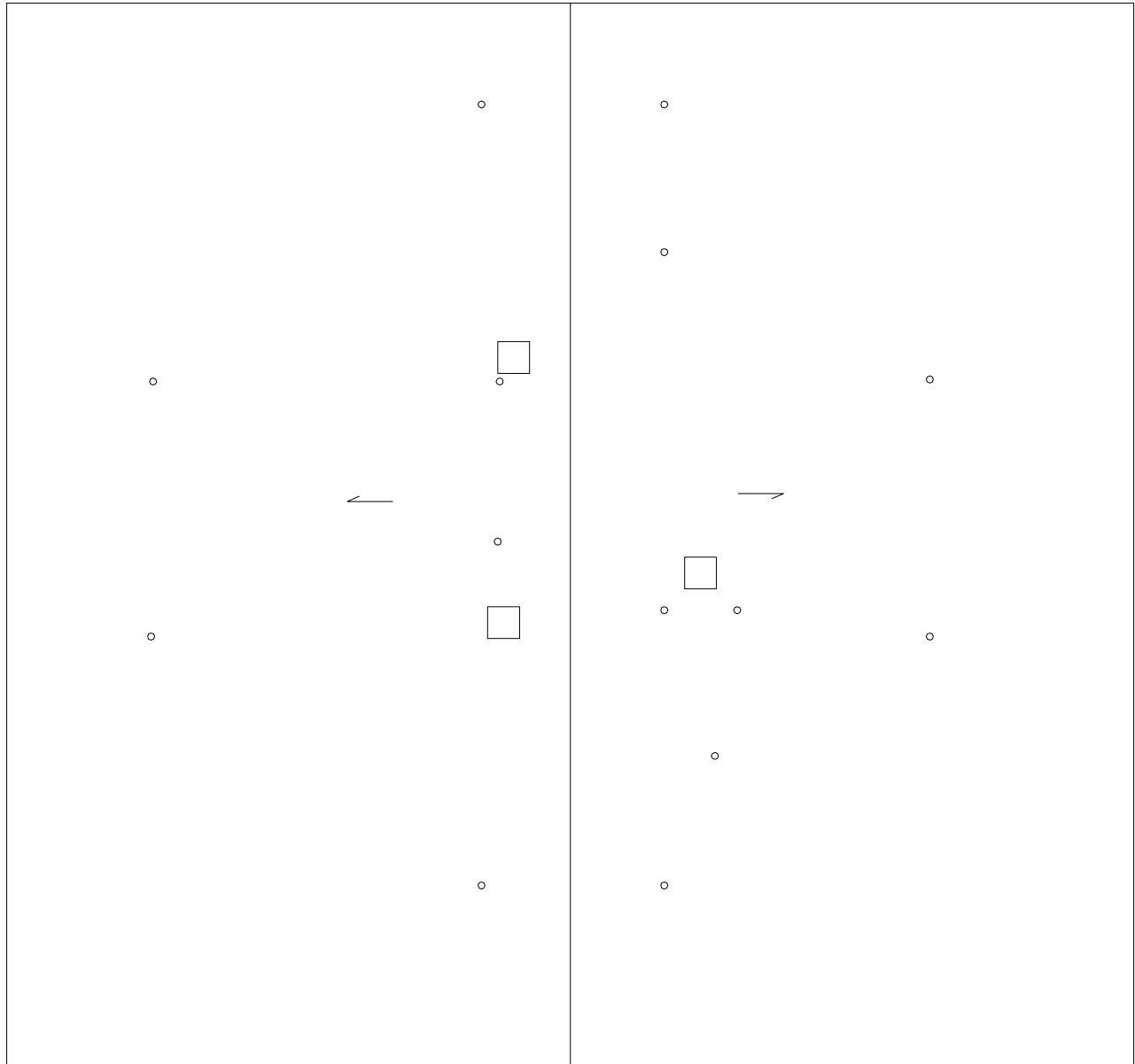

## SYMBOLS KEY

- ROOF CURB
- VENT STACK
- SLOPE DIRECTION

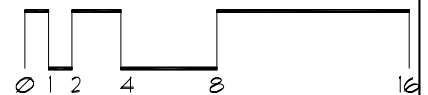

# Roof ID

Building: 03 - CT-03 - ()

Total Area: 2,650 sf

A 2,650 sf

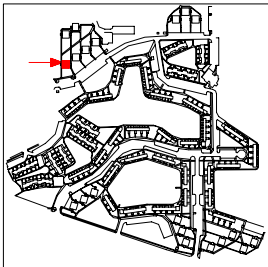
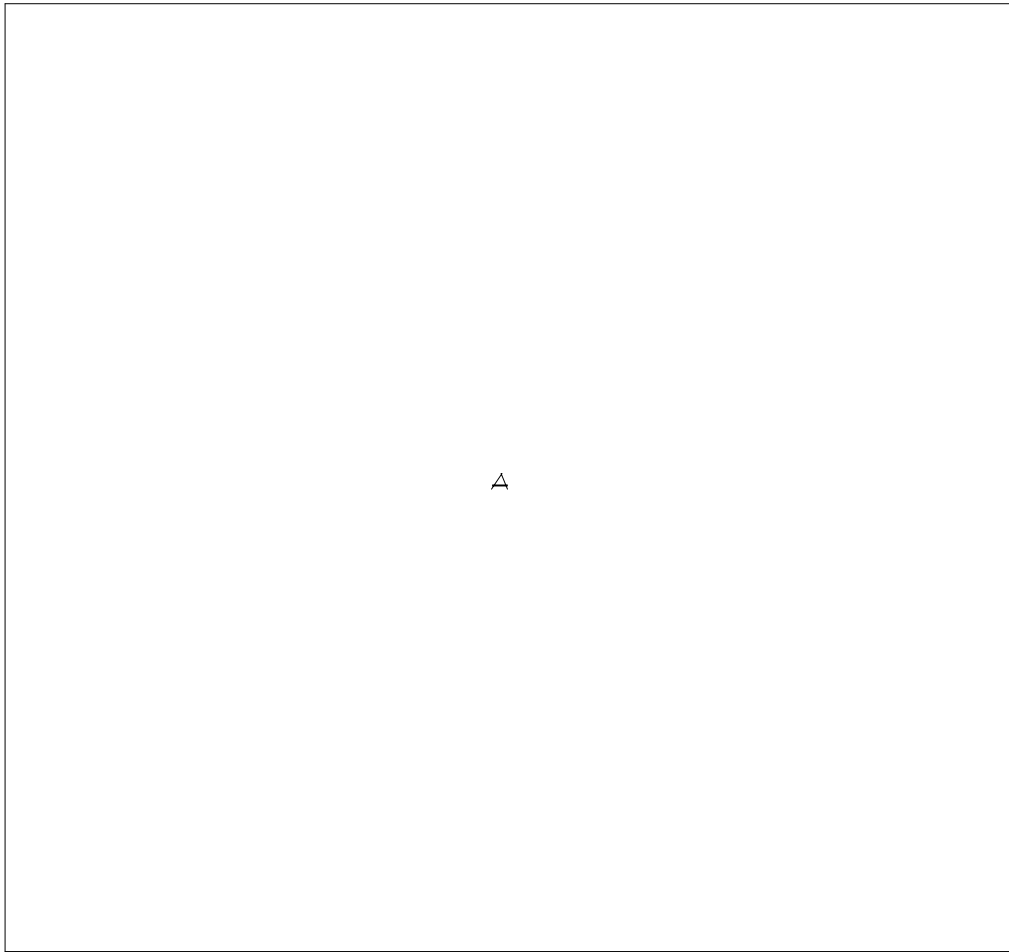

# Roof Corrective Action

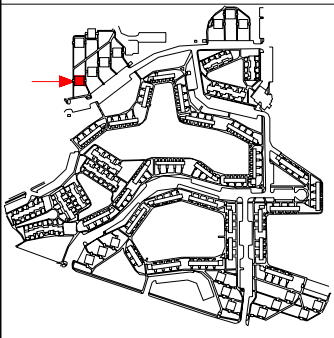
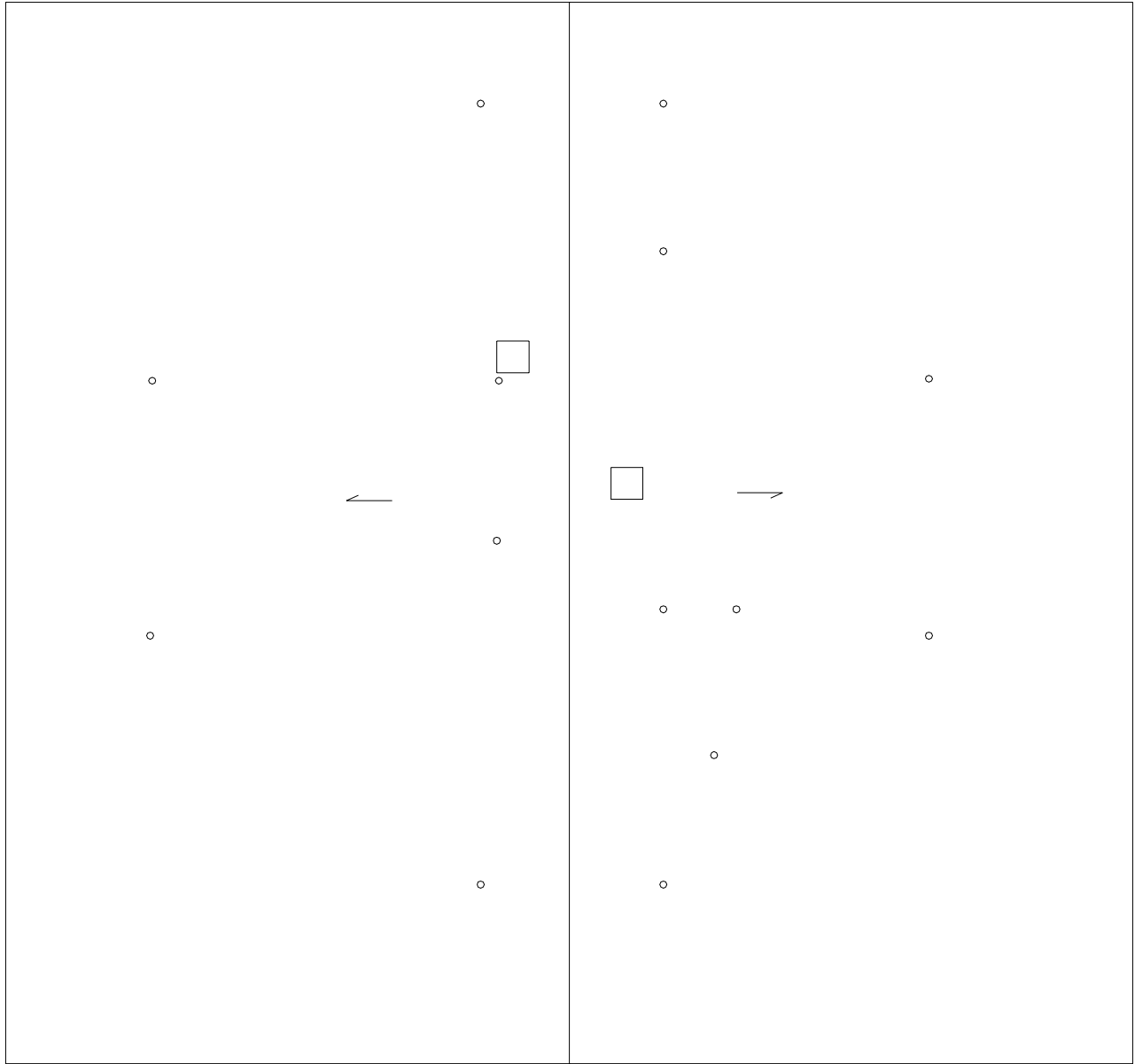

- SYMBOLS KEY**
- ROOF CURB
  - VENT STACK
  - SLOPE DIRECTION
  - Ⓢ DEFECT-REPAIR

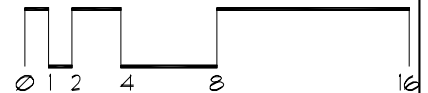

# Roof ID

Building: 04 - CT-04 - ()

Total Area: 2,650 sf

A 2,650 sf

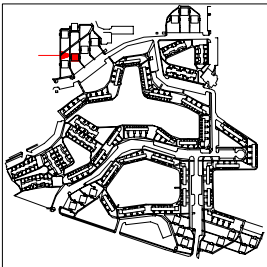
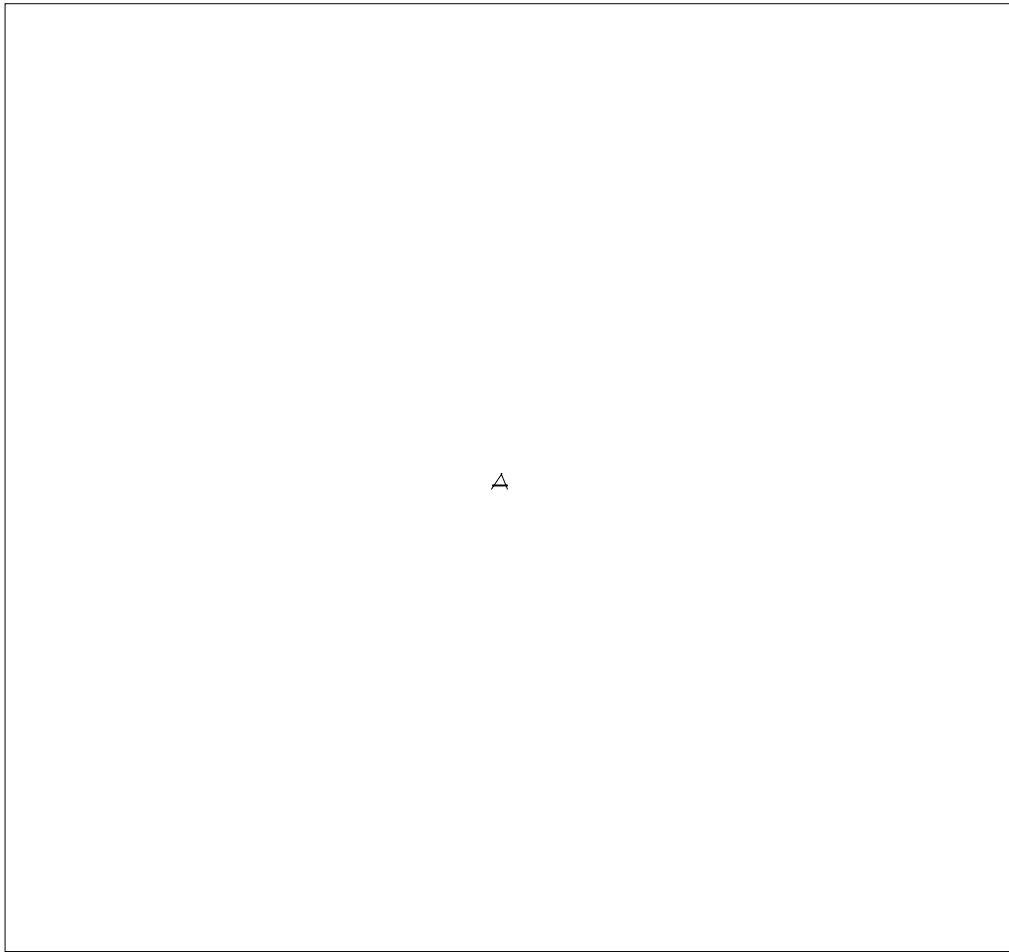

# Roof Corrective Action

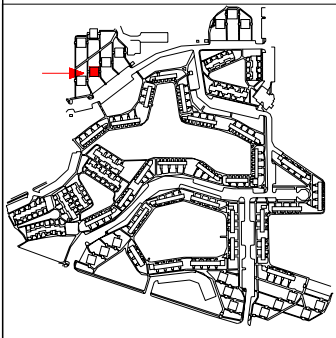
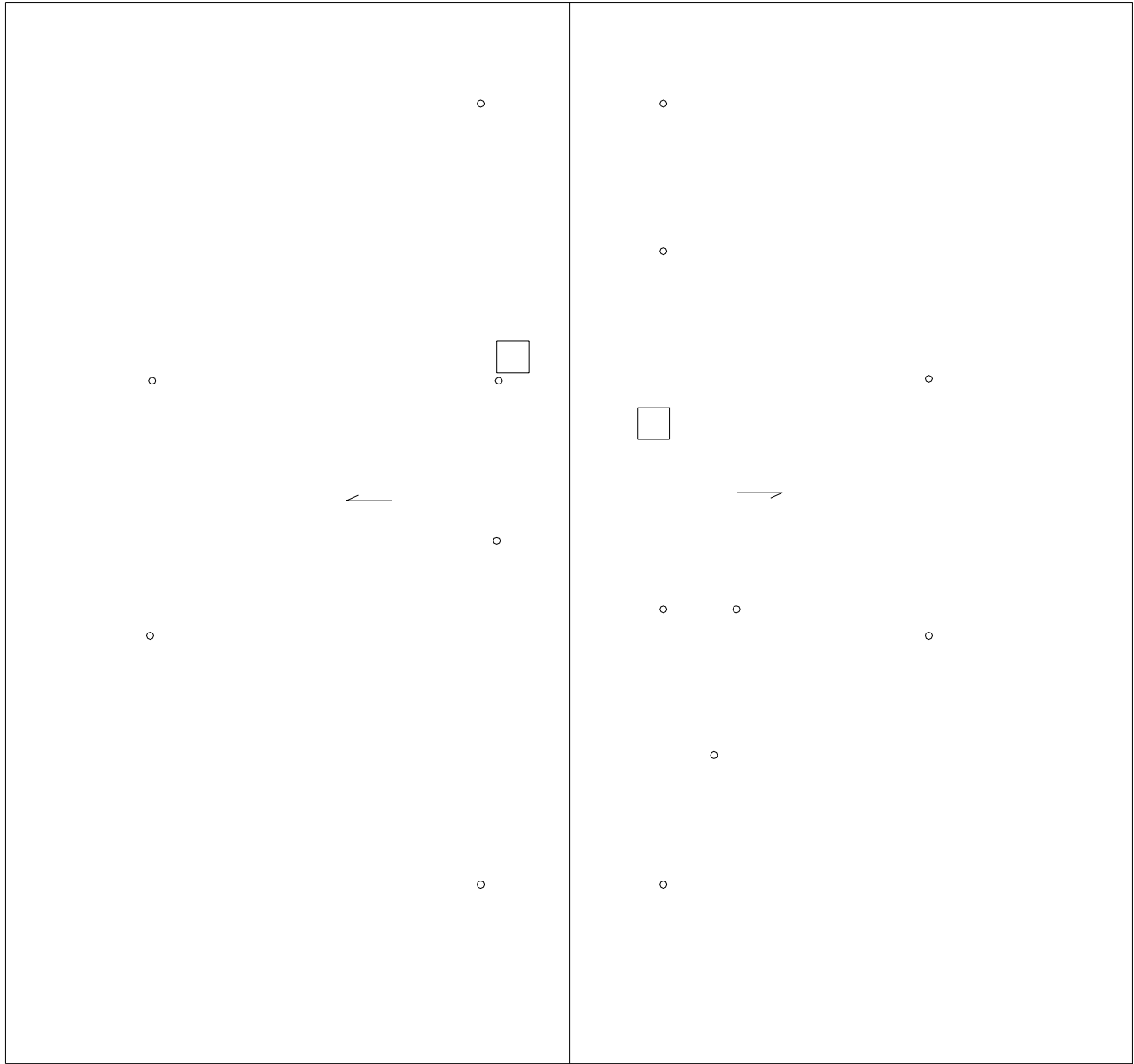

- SYMBOLS KEY**
- ROOF CURB
  - VENT STACK
  - SLOPE DIRECTION

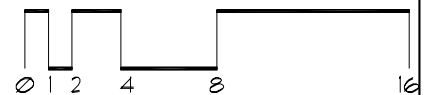

# Roof ID

Building: 05 - CT-05 - ()

Total Area: 2,650 sf

A 2,650 sf

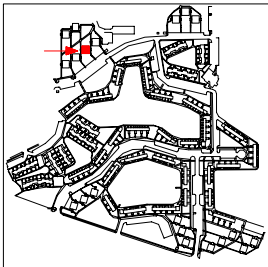
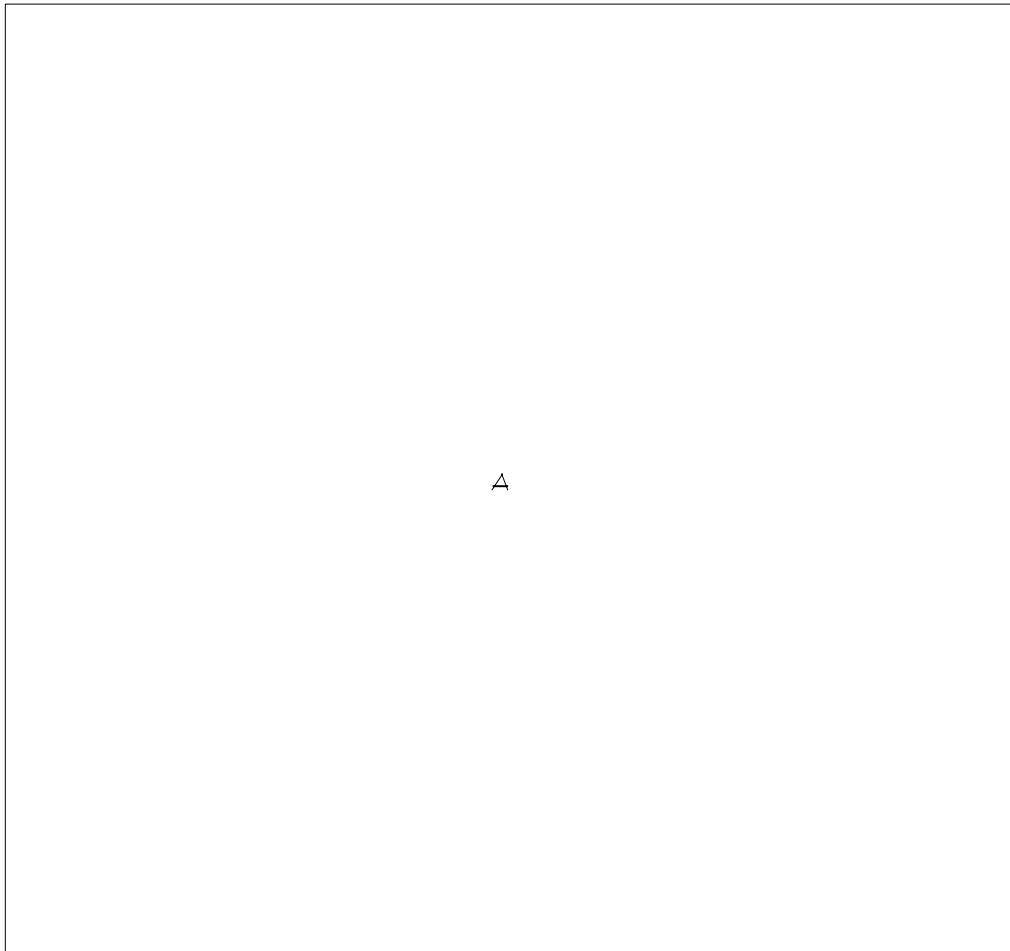

# Roof Corrective Action

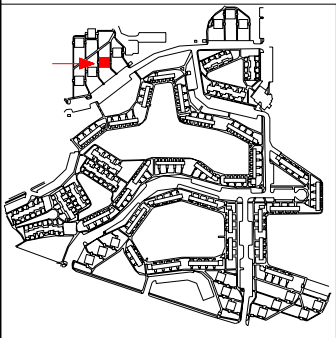
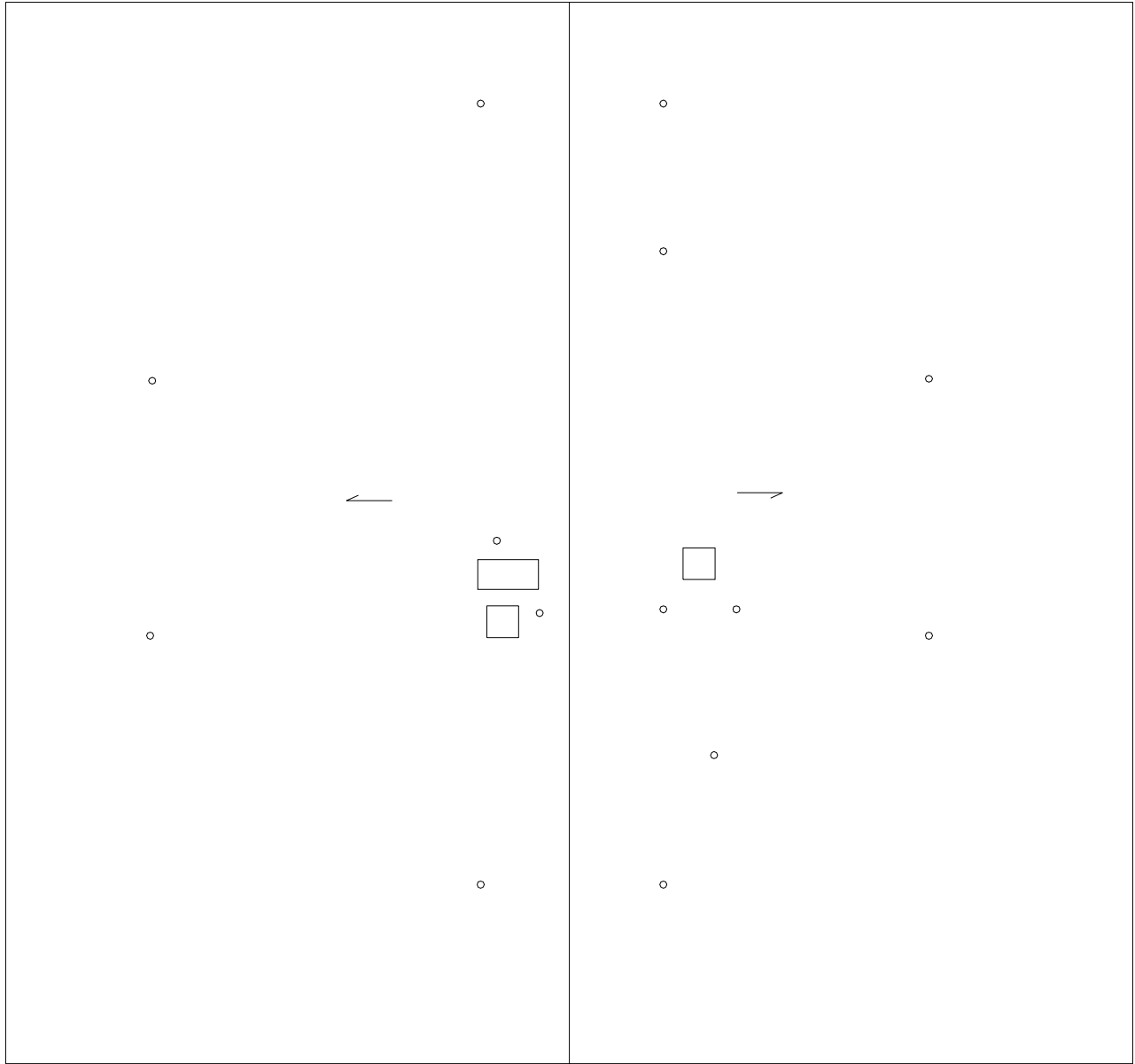

## SYMBOLS KEY

- ROOF CURB
- VENT STACK
- SLOPE DIRECTION

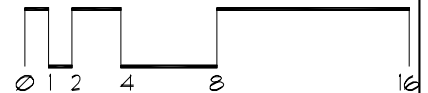

# Roof ID

Building: 06 - CT-06 - ()

Total Area: 2,650 sf

A 2,650 sf

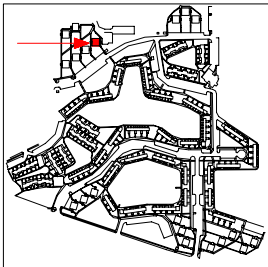
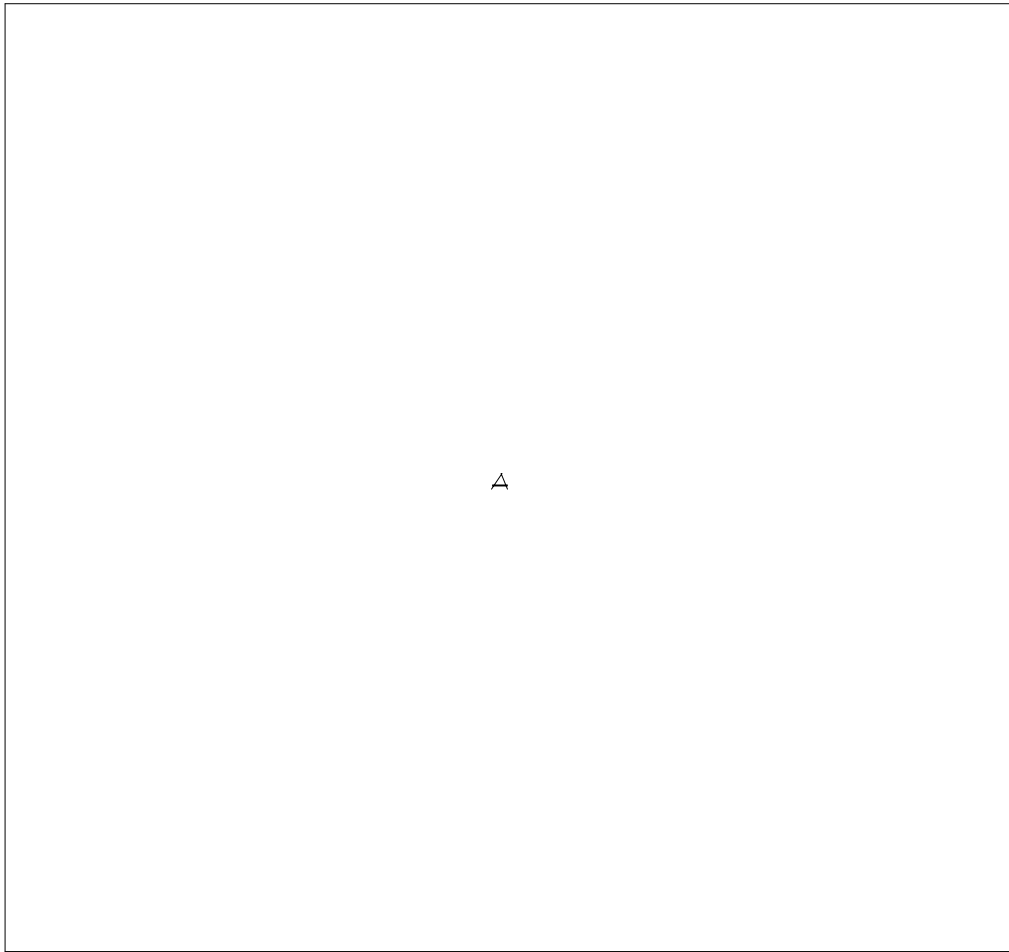



# Roof Corrective Action

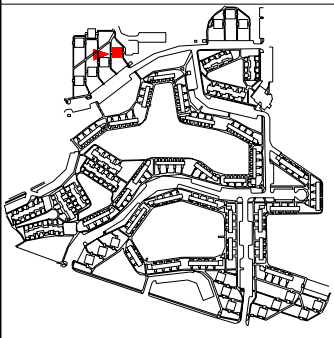
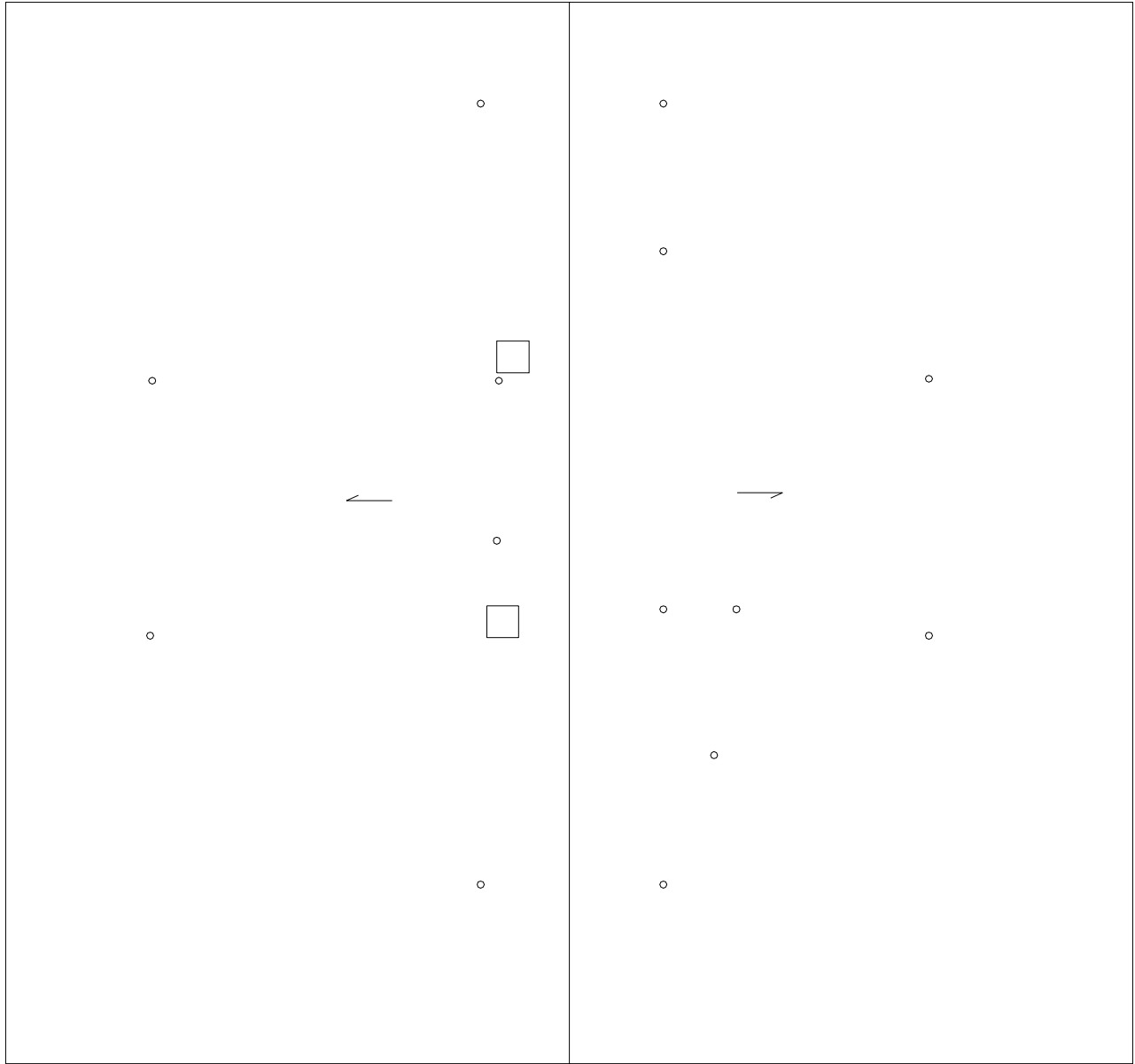

**SYMBOLS KEY**

- ROOF CURB
- VENT STACK
- SLOPE DIRECTION
- Ⓢ DEFECT-REPAIR

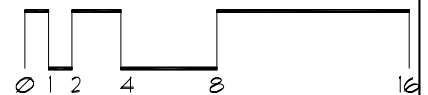

# Roof ID

Building: 07 - CT-07 - ( )

Total Area: 2,650 sf

A 2,650 sf

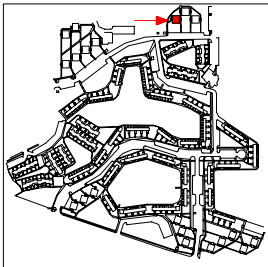
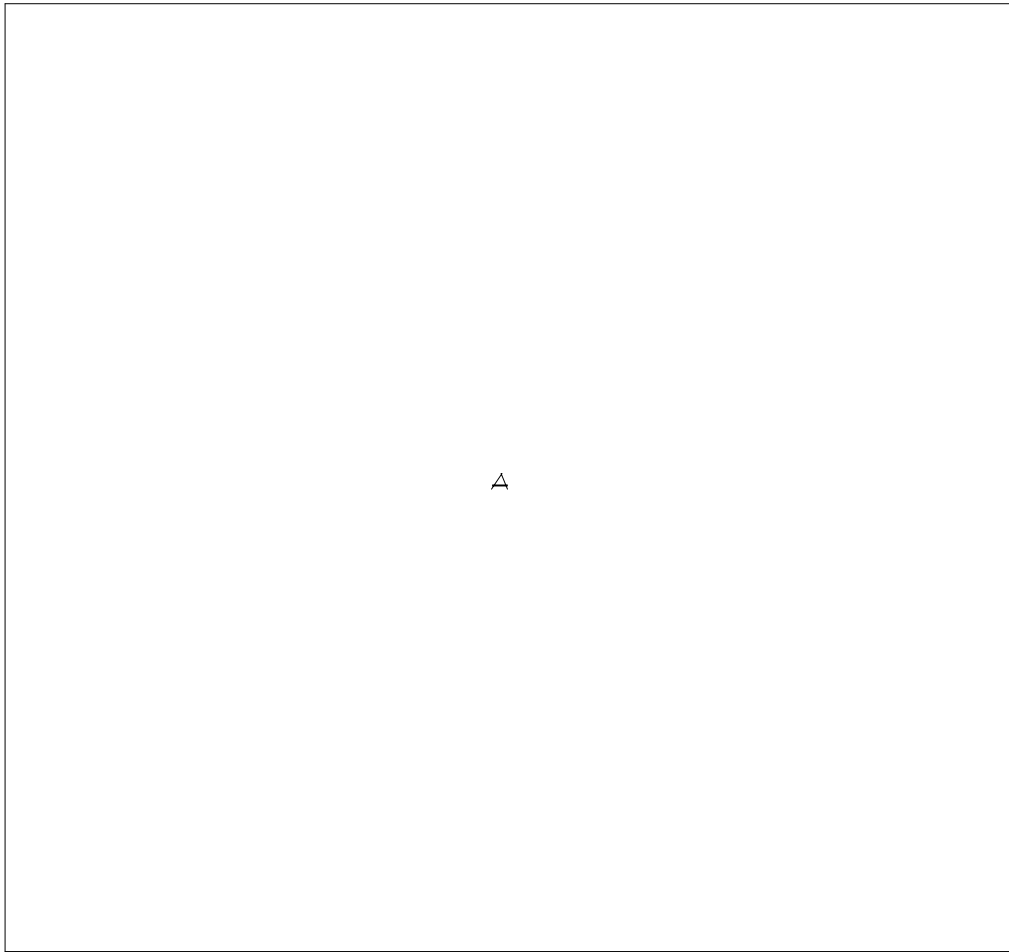

# Roof Corrective Action

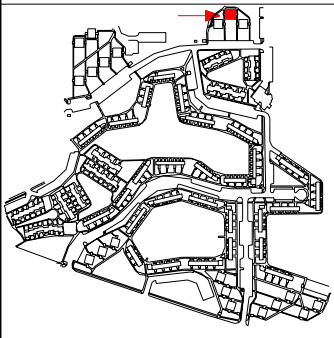
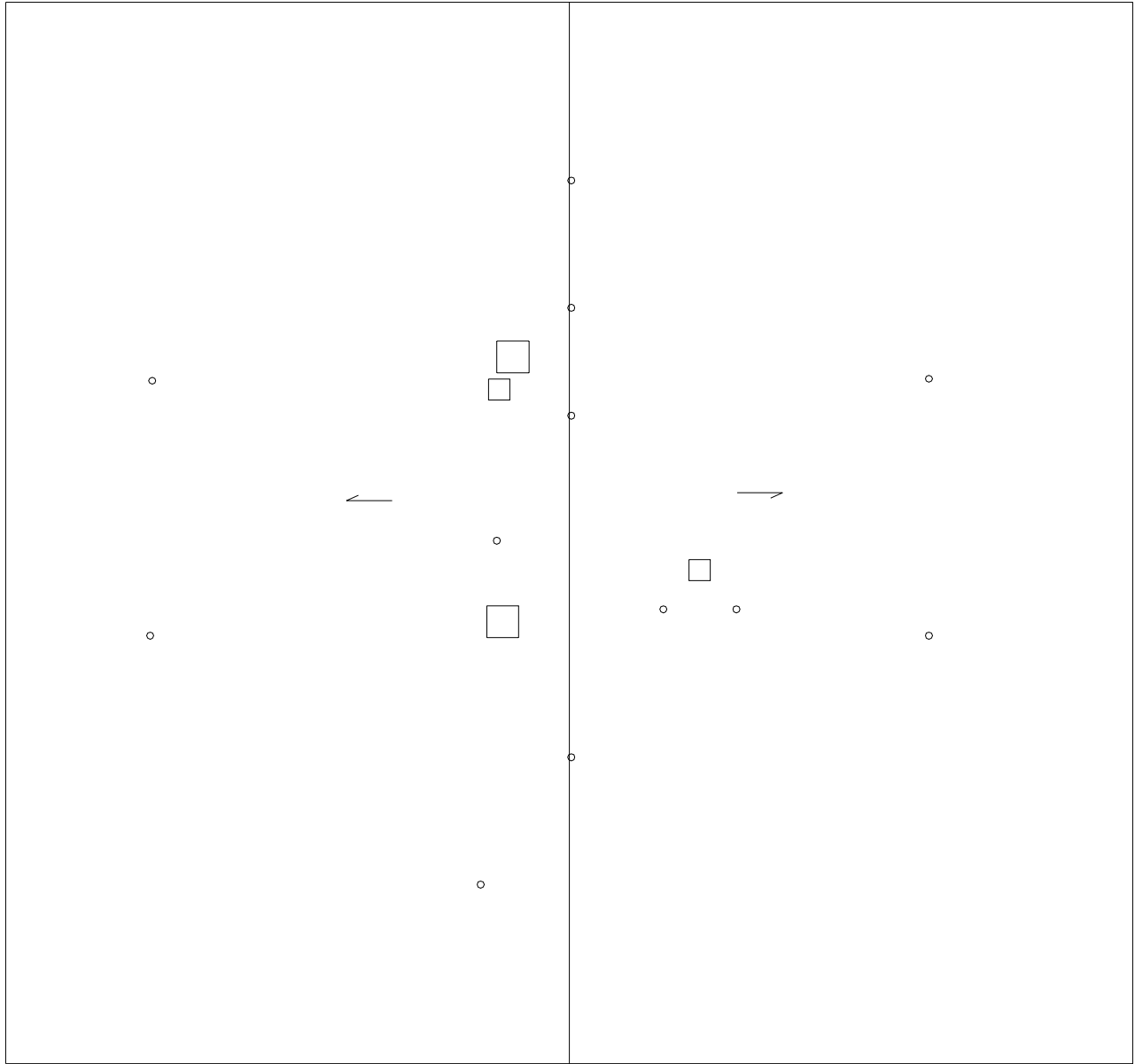

## SYMBOLS KEY

- ROOF CURB
- VENT STACK
- SLOPE DIRECTION

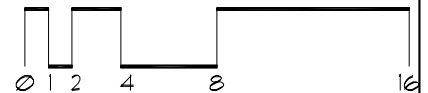

# Roof ID

Building: 08 - CT-08 - ()

Total Area: 2,650 sf

A 2,650 sf

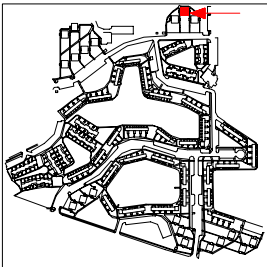
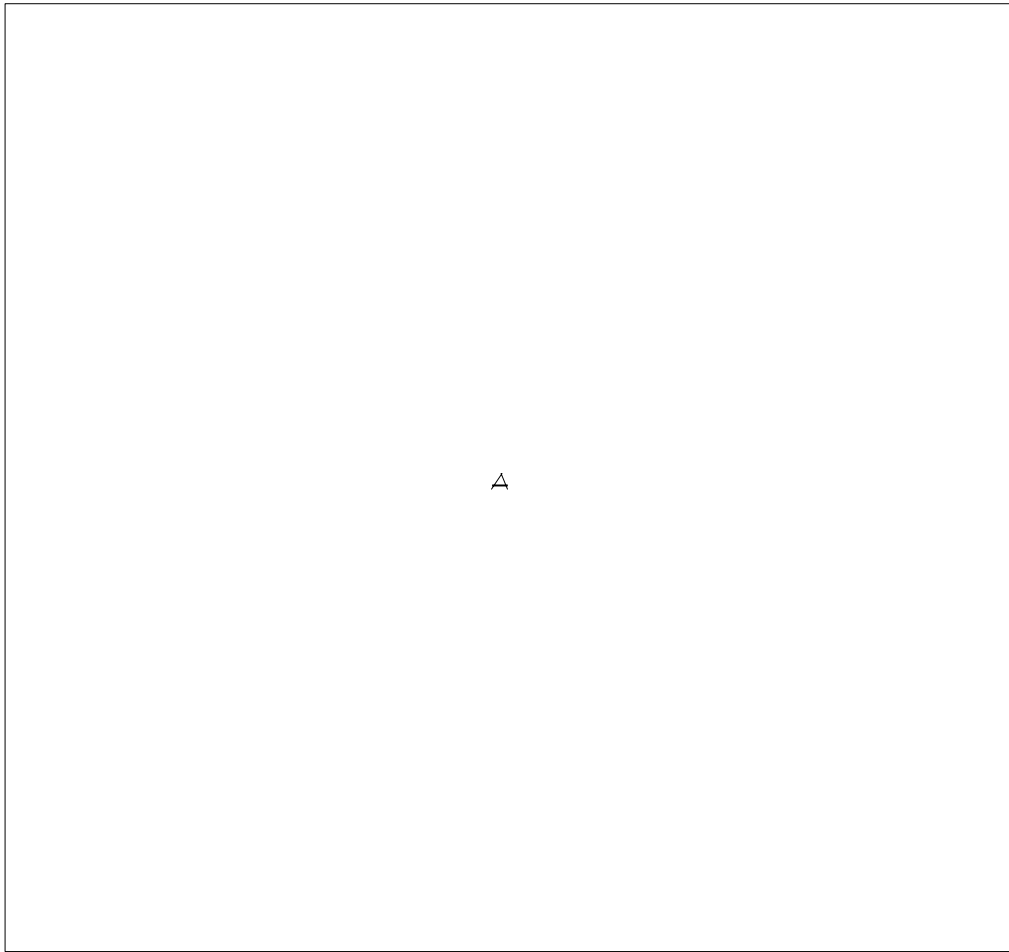

# Roof Corrective Action

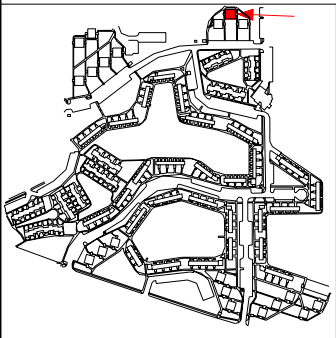
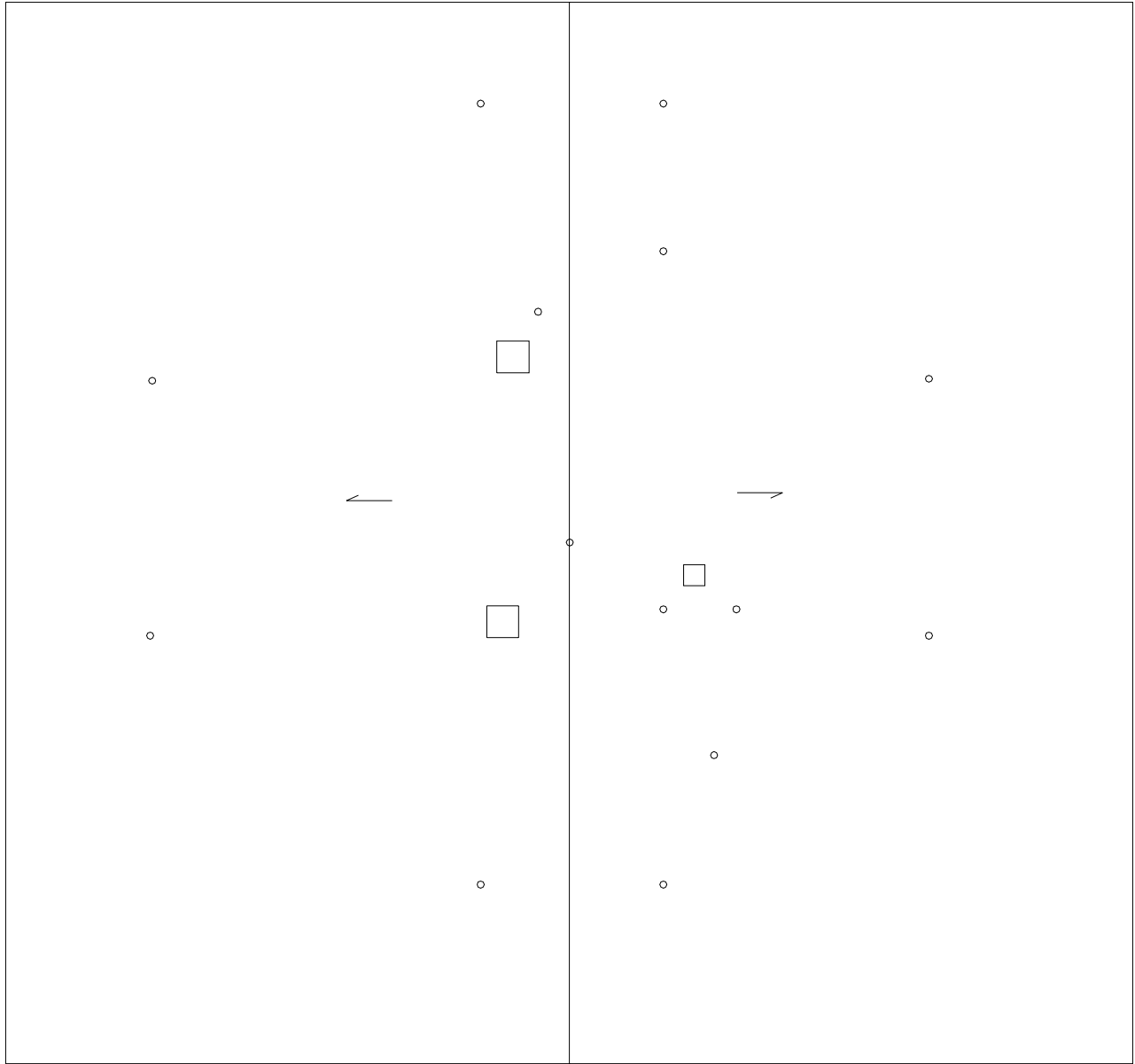

## SYMBOLS KEY

- ROOF CURB
- VENT STACK
- SLOPE DIRECTION
- Ⓢ DEFECT-REPAIR

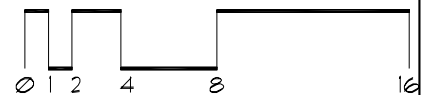

# Roof ID

Building: 09 - CT-09 - ( )

Total Area: 2,650 sf

A 2,650 sf

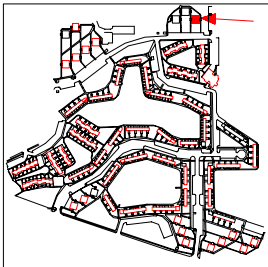
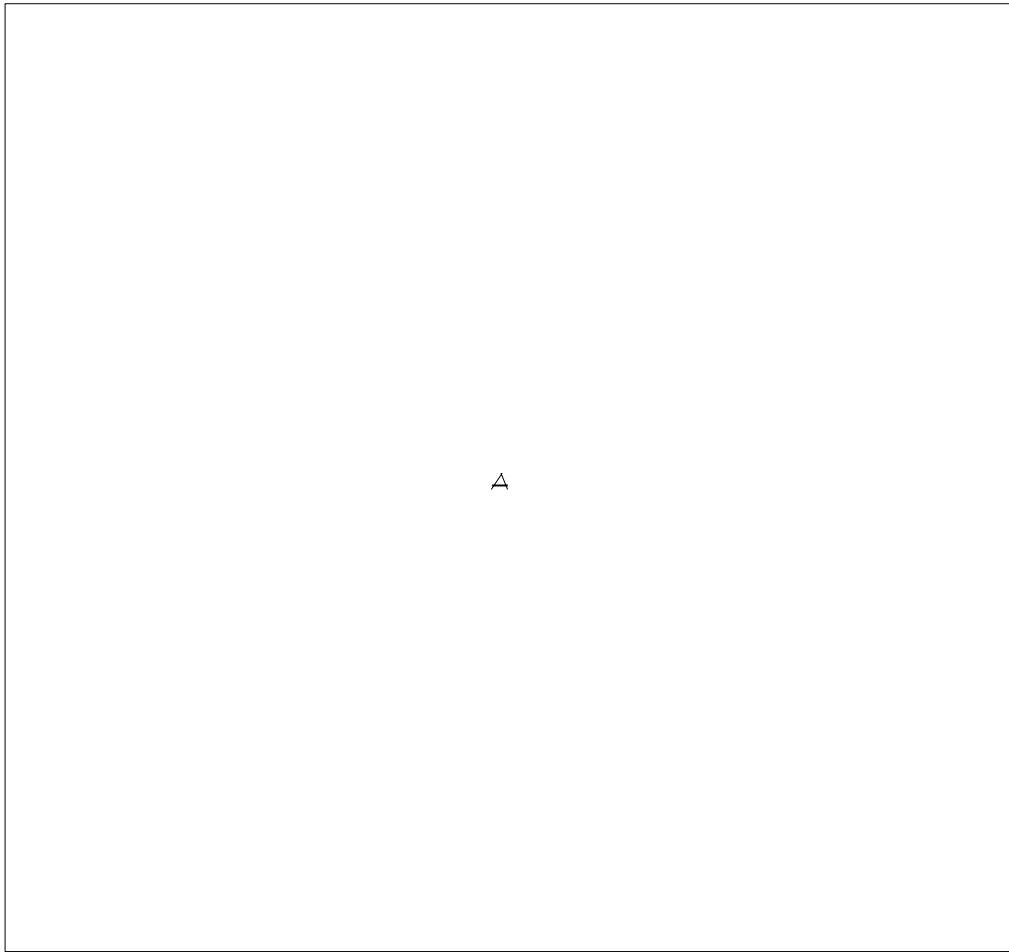

# Roof Corrective Action

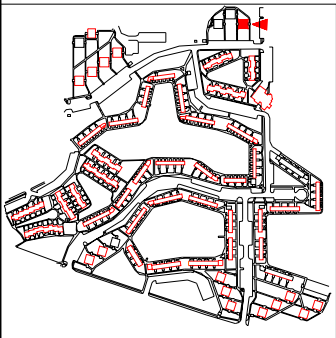
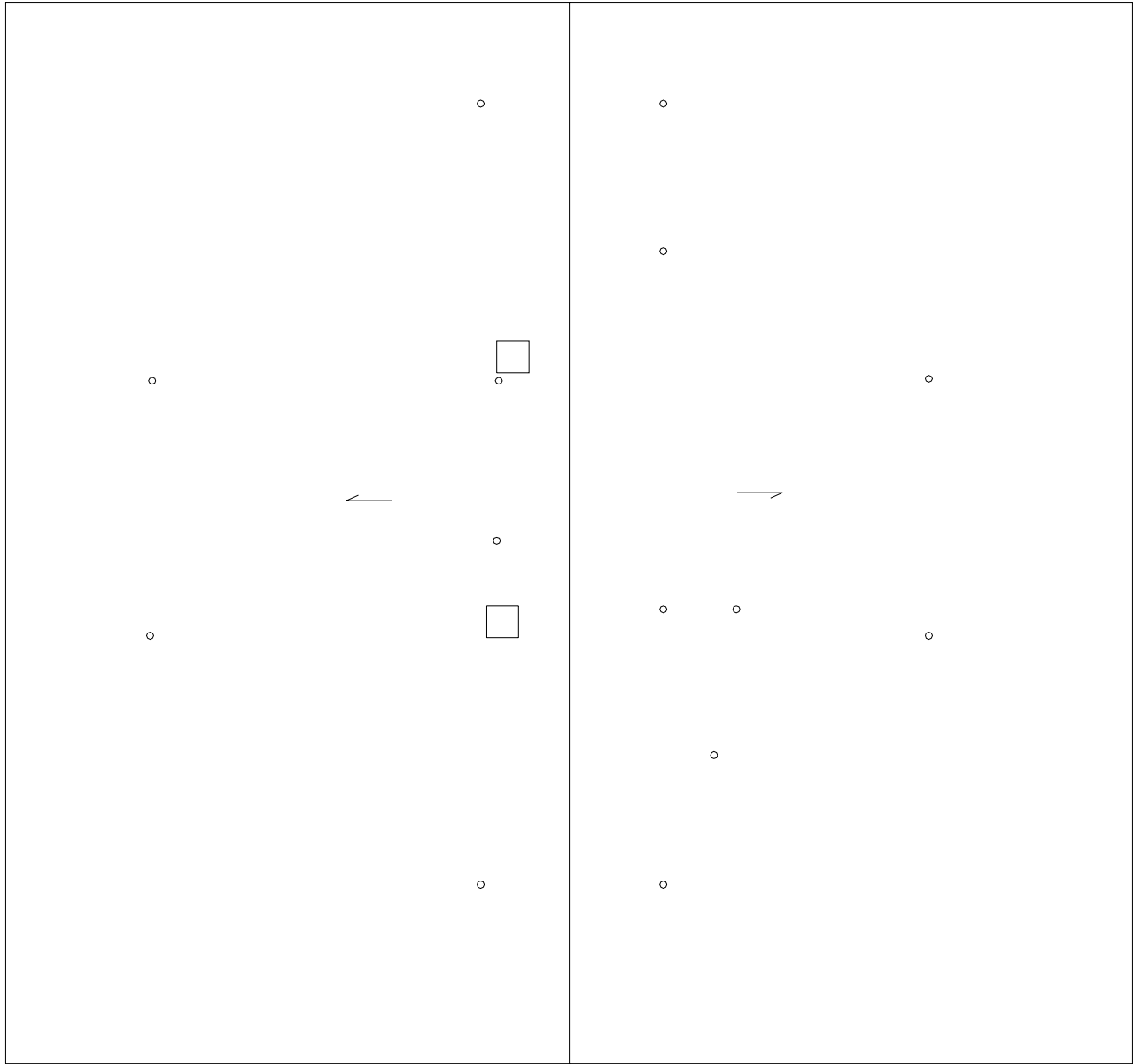

## SYMBOLS KEY

- ROOF CURB
- VENT STACK
- SLOPE DIRECTION
- Ⓜ DEFECT-REPAIR

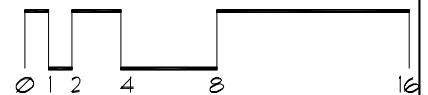

# Roof ID

Building: 10 - CT-10 - ()

Total Area: 4,664 sf

A 4,234 sf

B 430 sf

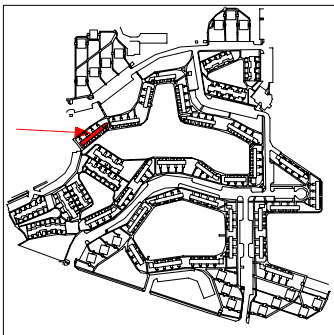
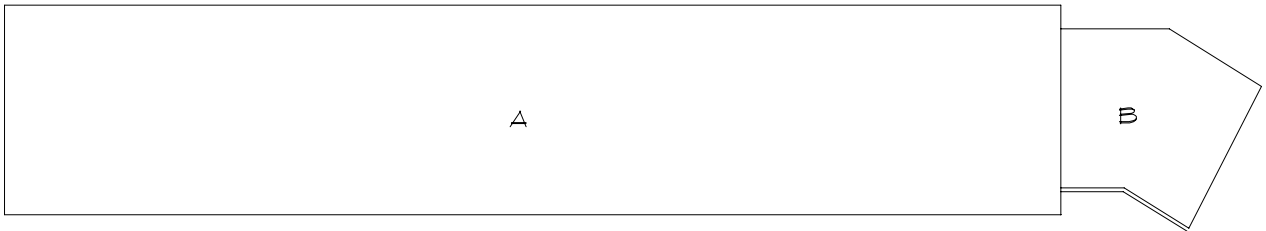



# Roof Corrective Action

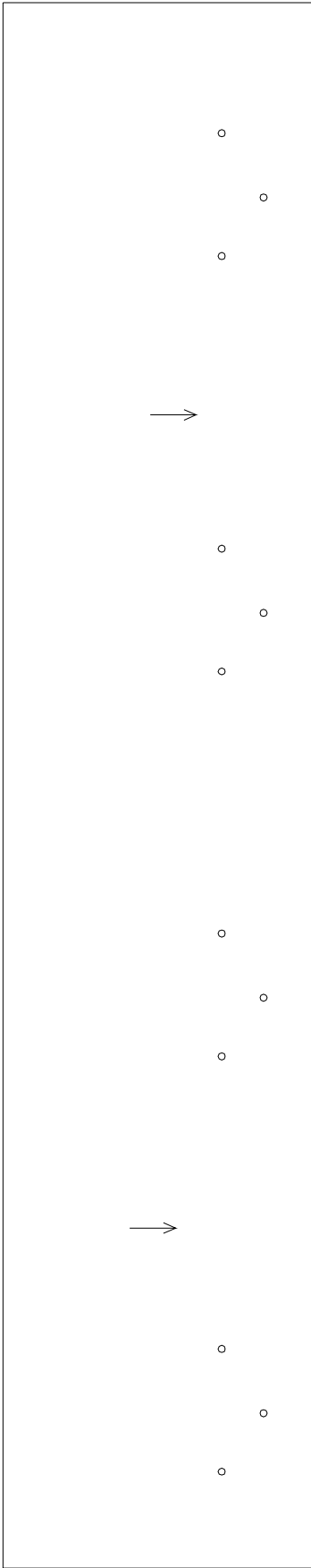
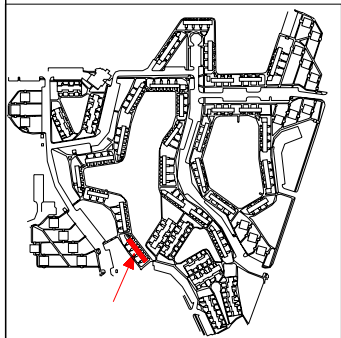

**SYMBOLS KEY**  
○ VENT STACK  
DEFECT-REPAIR  
→ STRUCTURAL SLOPE

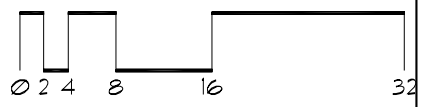
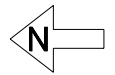

# Roof Corrective Action

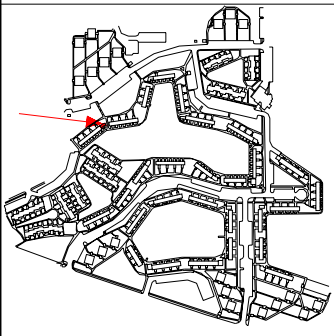
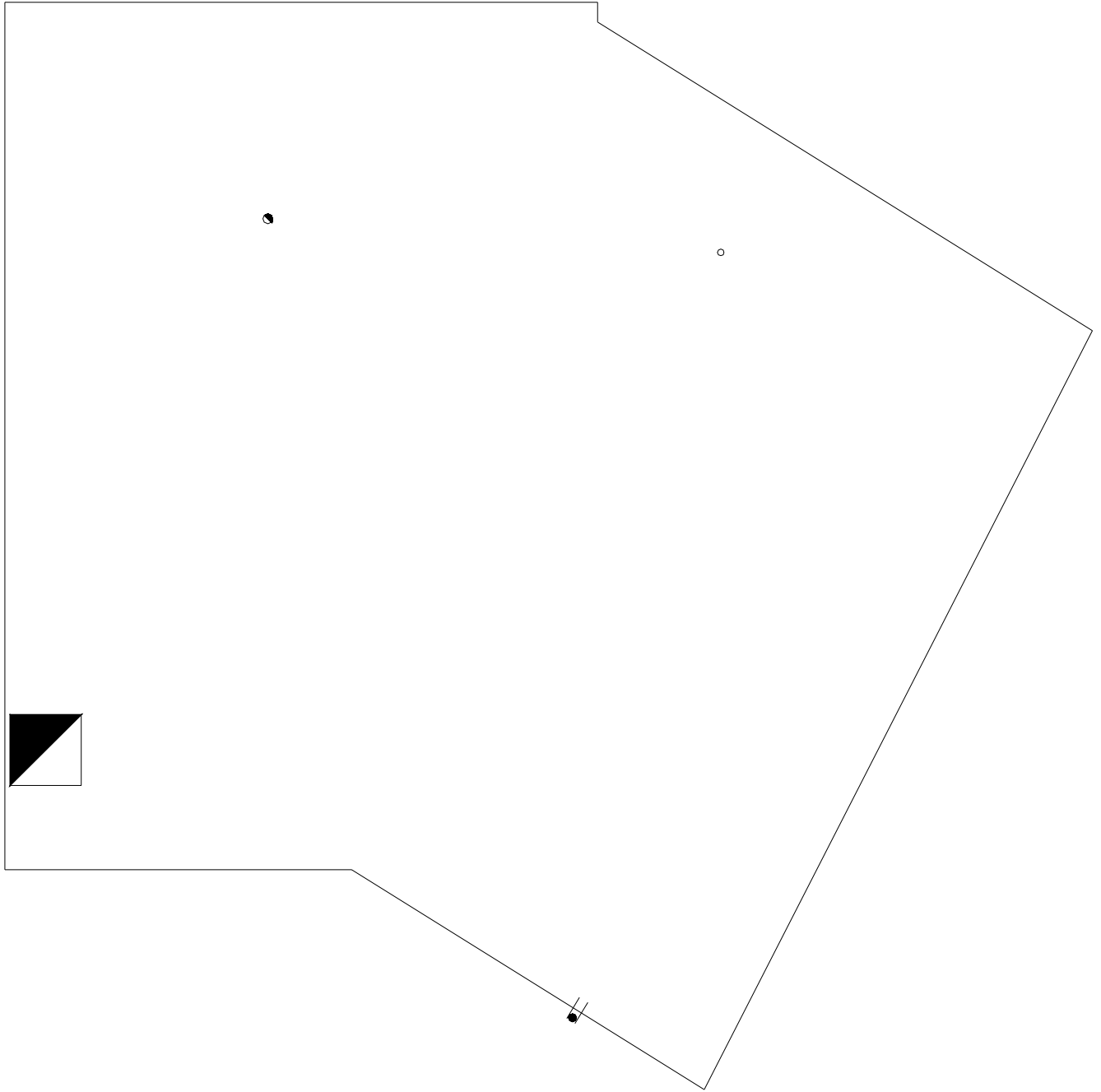

## SYMBOLS KEY

- VENT STACK
- CHIMNEY
- HEAT STACK
- ⊥ SCUPPER
- DEFECT-REPAIR
- ① DEFECT-NO REPAIR

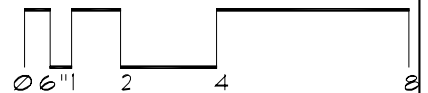

# Roof ID

Building: 11 - CT-11 - ()

Total Area: 4,234 sf

A 4,234 sf

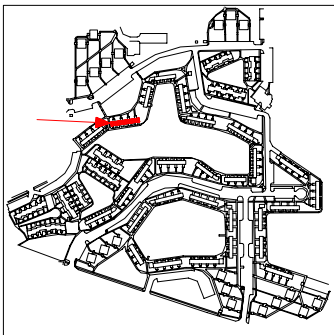
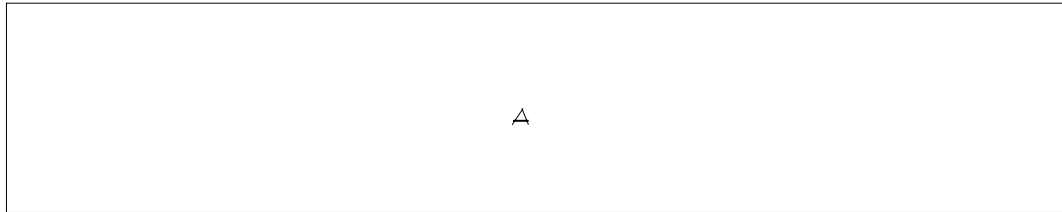

# Roof Corrective Action

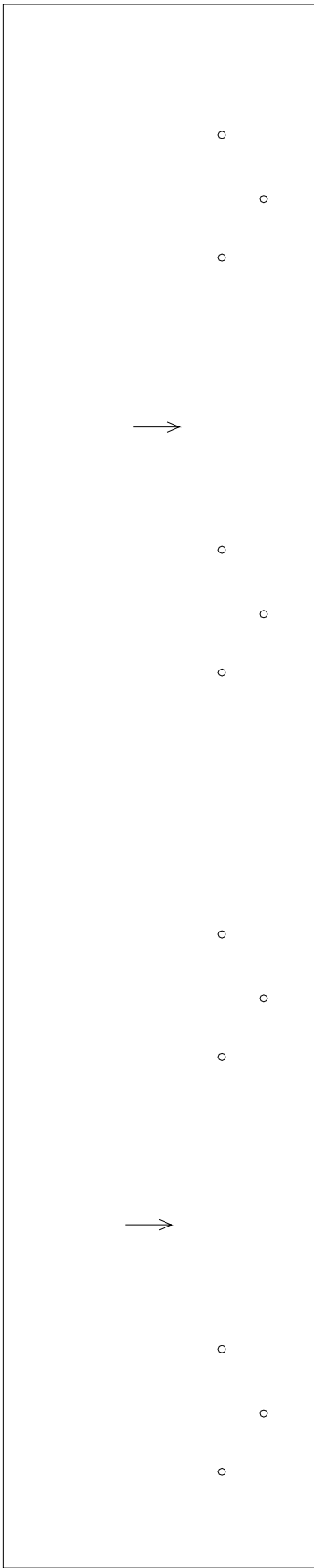

## SYMBOLS KEY

- VENT STACK
- ⊖ DEFECT-REPAIR
- STRUCTURAL SLOPE

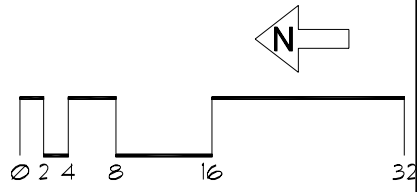
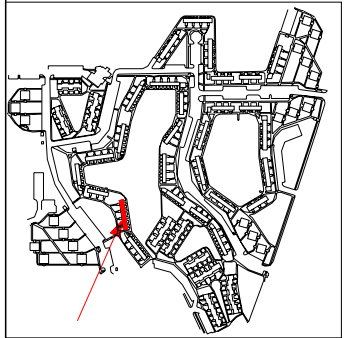

# Roof ID

Building: 12 - CT-12 - ()

Total Area: 3,190 sf

A 3,190 sf

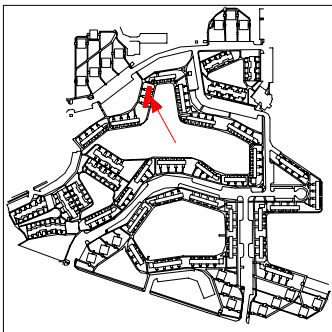
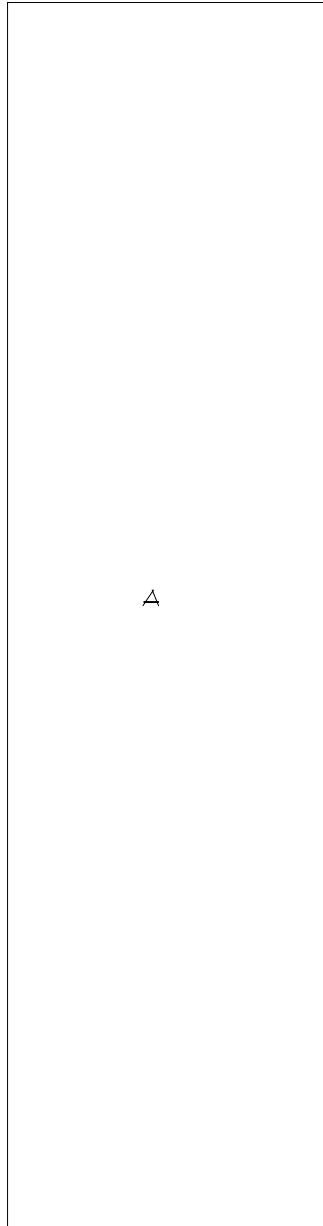

# Roof Corrective Action

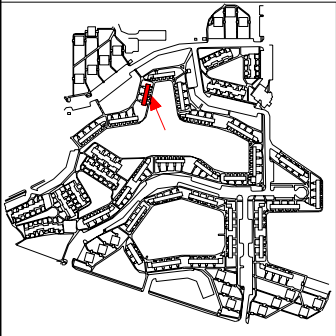
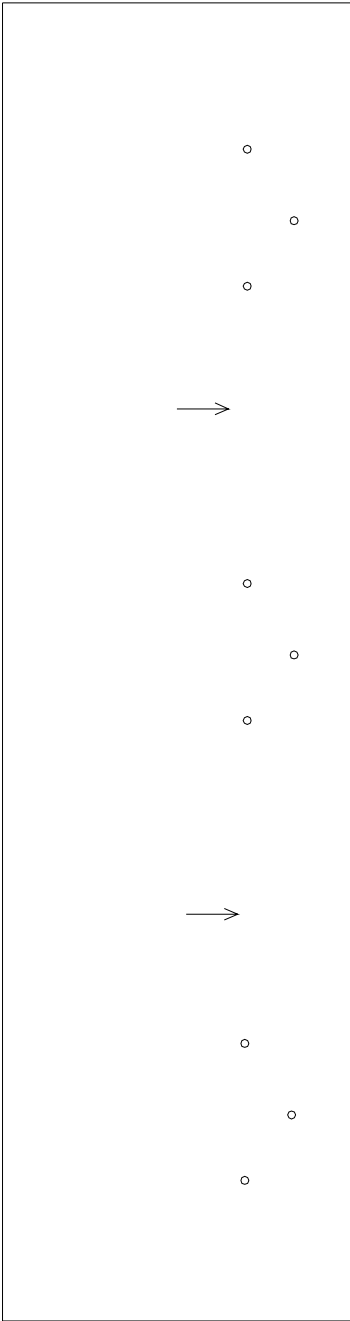

## SYMBOLS KEY

- VENT STACK
- Ⓢ DEFECT-REPAIR
- STRUCTURAL SLOPE

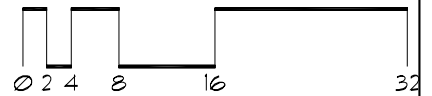

# Roof ID

Building: 13 - CT-13 - ()

Total Area: 3,709 sf

A 3,190 sf

B 519 sf

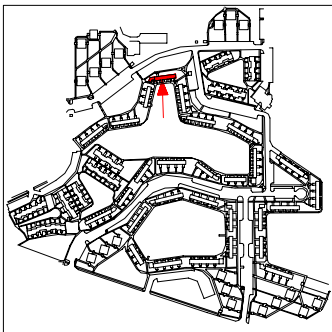

# Roof Corrective Action

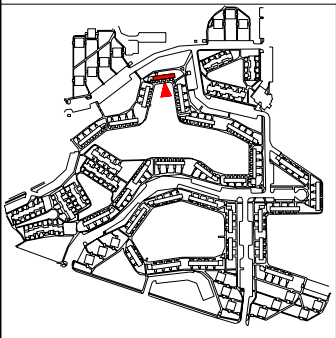
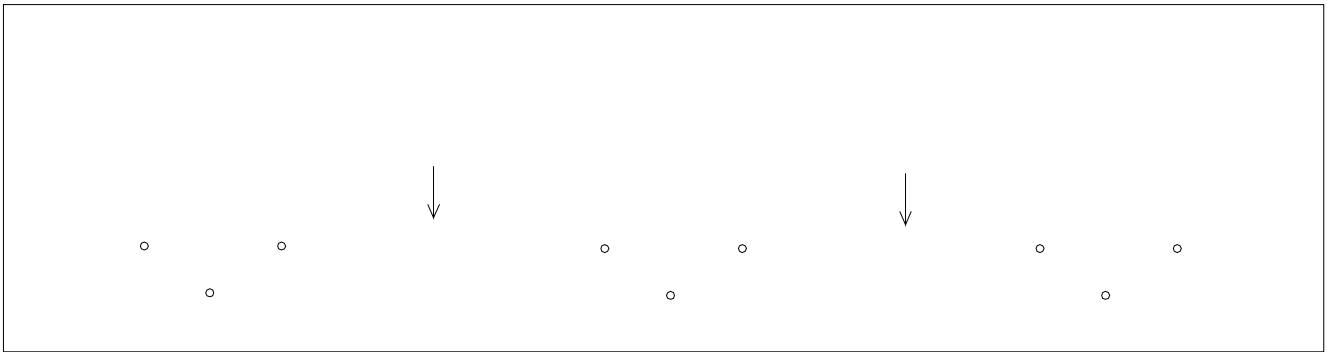

## SYMBOLS KEY

- VENT STACK
- ⊖ DEFECT-REPAIR
- STRUCTURAL SLOPE

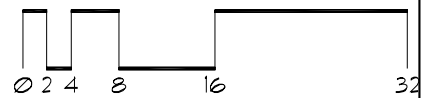



# Roof Corrective Action

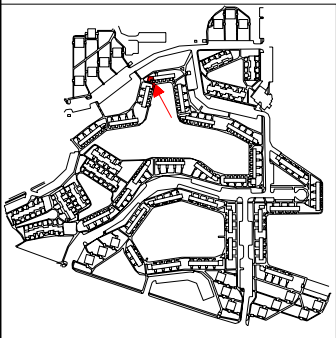
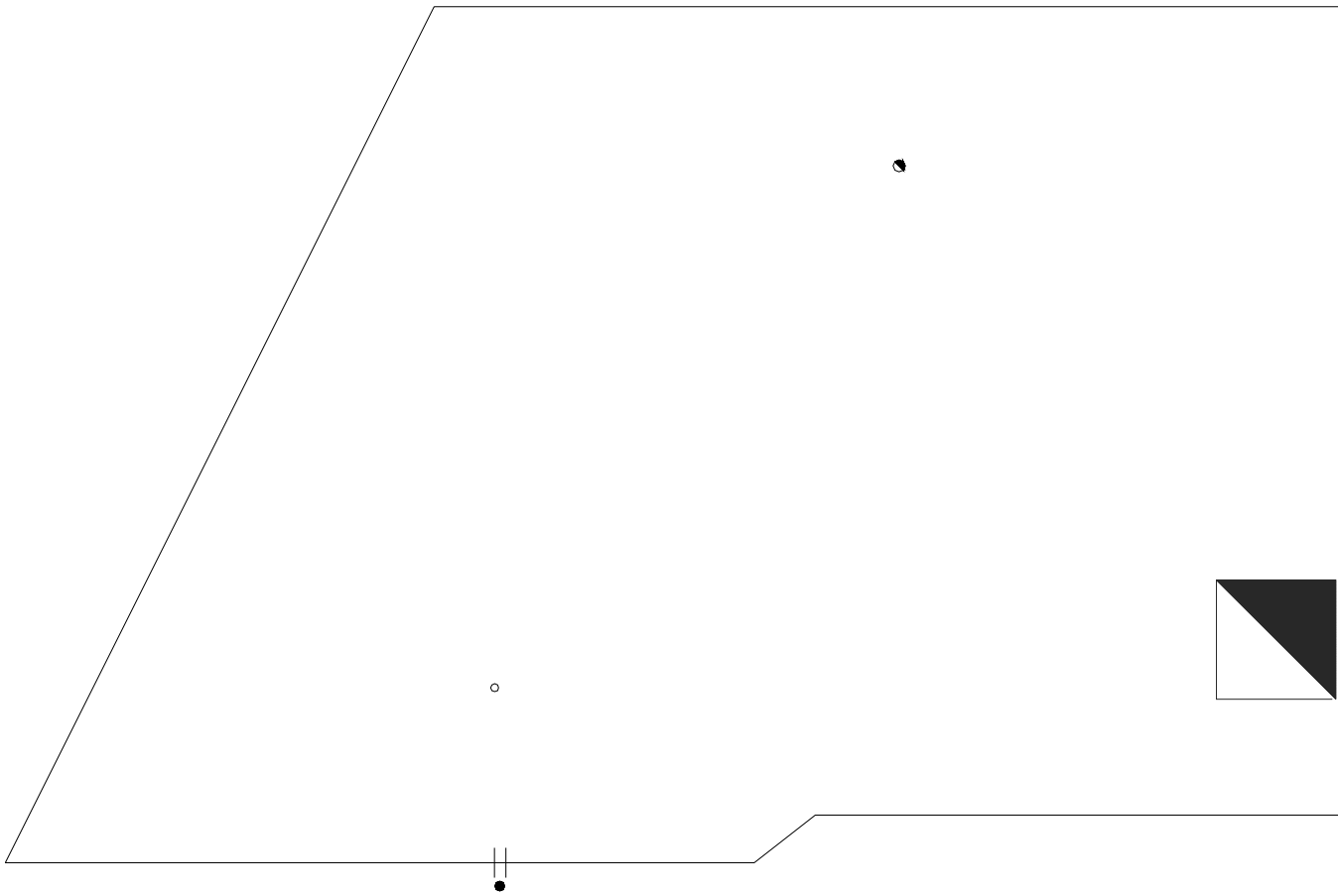

## SYMBOLS KEY

- VENT STACK
- ◼ CHIMNEY
- DOWNSPOUT
- ≡ SCUPPER
- ◐ HEAT STACK

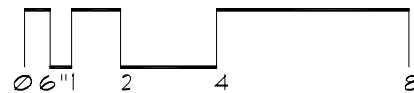

# Roof ID

Building: 14 - CT-14 - ()

Total Area: 357 sf

A 357 sf

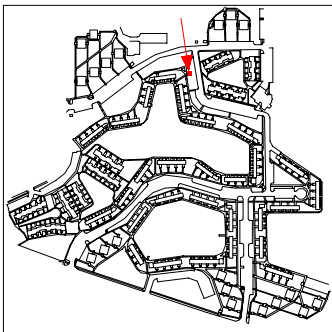
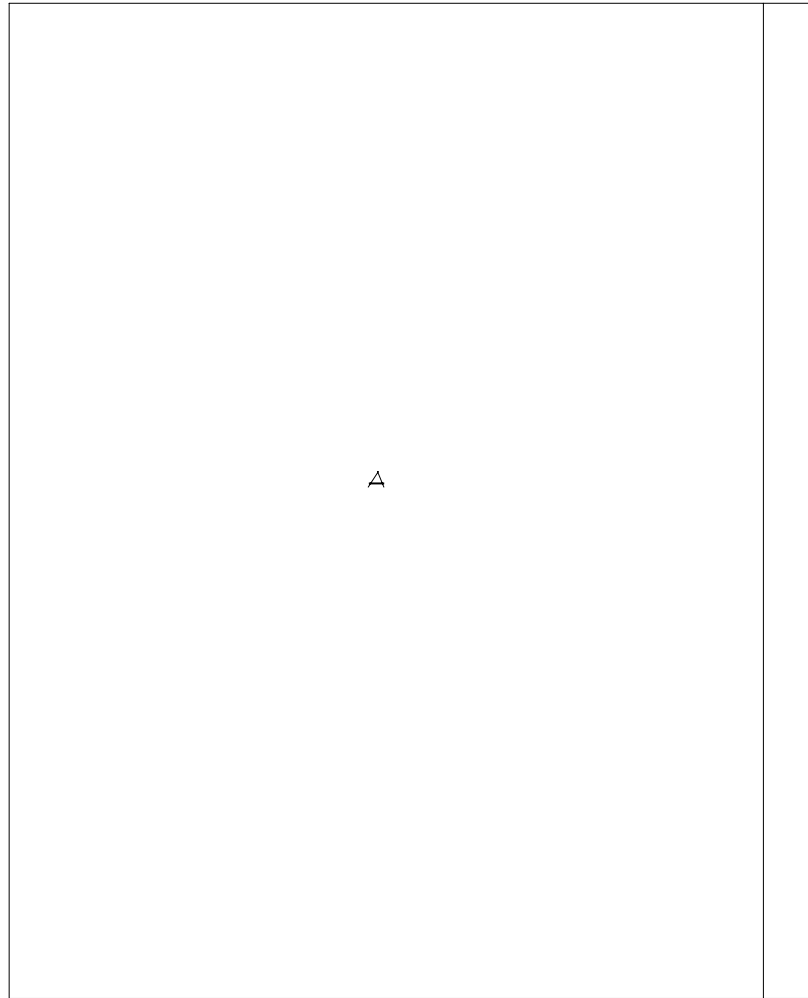

# Roof Corrective Action

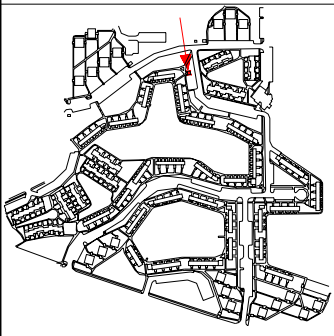
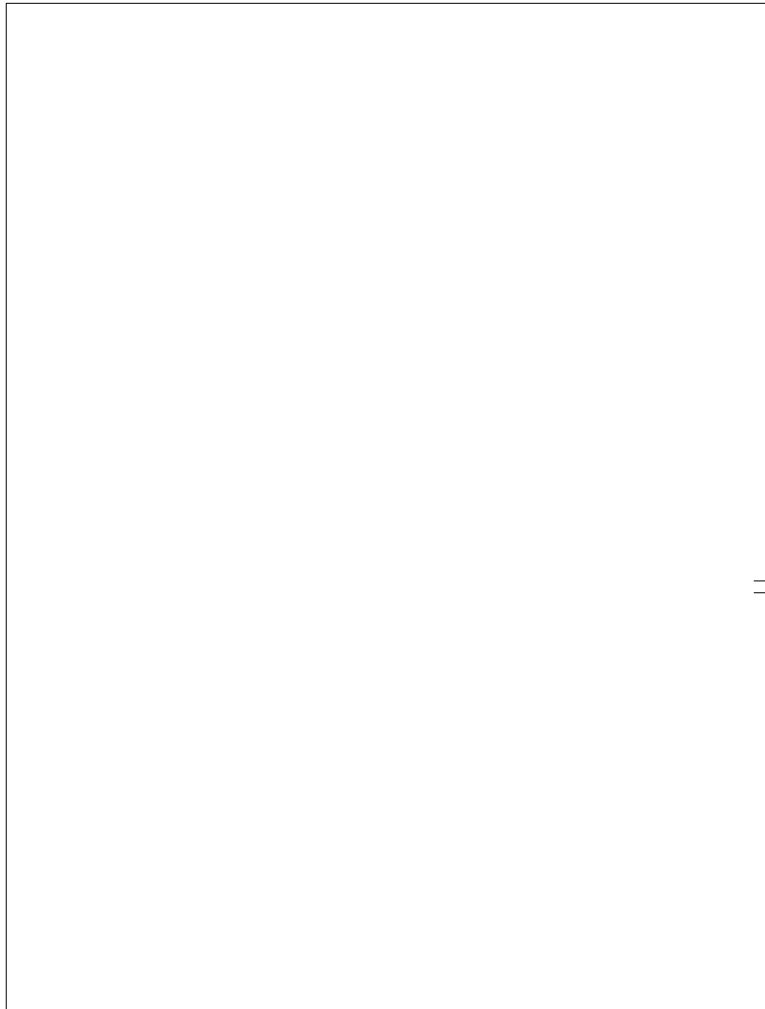

## SYMBOLS KEY

- DOWNSPOUT
- † SCUPPER
- ⊖ DEFECT-REPAIR

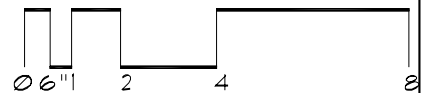

# Roof ID

Building: 15 - CT-15 - ()

Total Area: 4,234 sf

A 4,234 sf

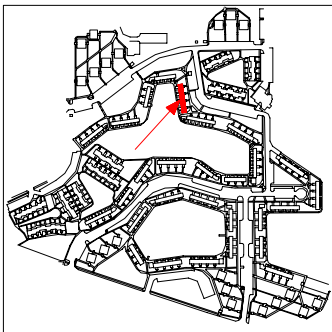
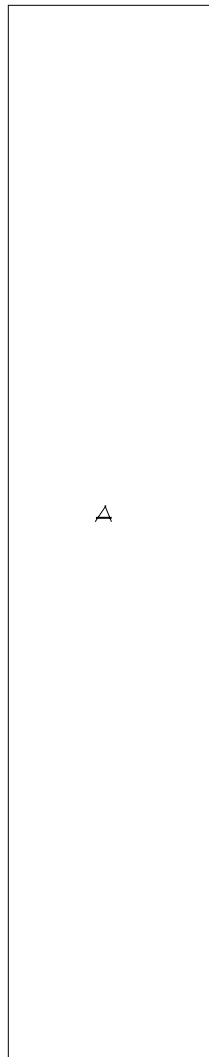

# Roof Corrective Action

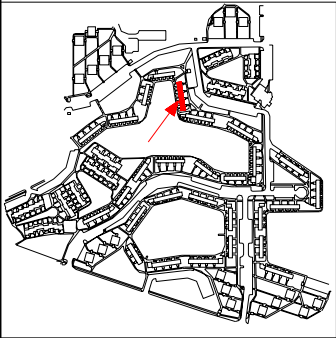
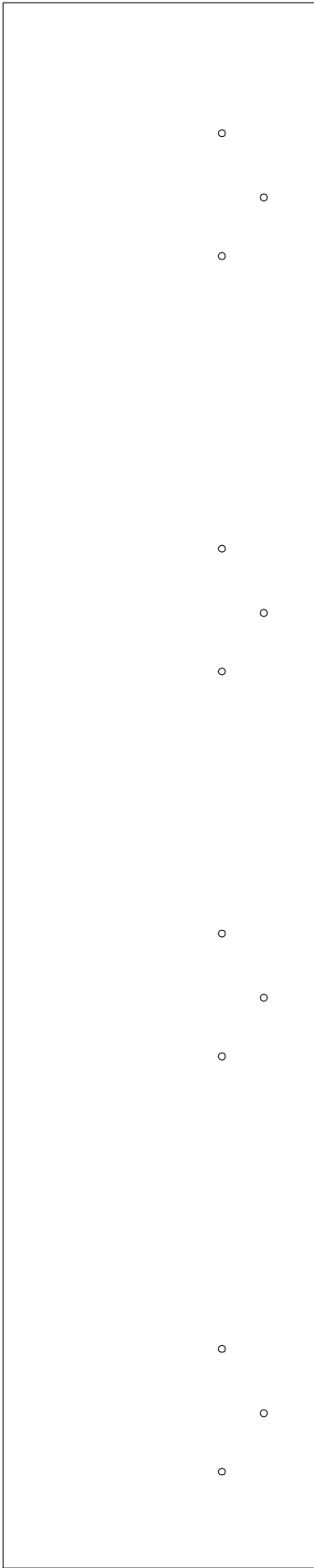

SYMBOLS KEY  
○ VENT STACK  
Ⓢ DEFECT-REPAIR

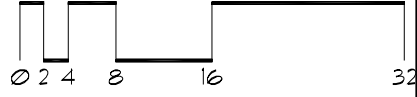
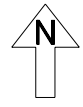

# Roof ID

Building: 16 - CT-16 - ()

Total Area: 4,729 sf

A 4,234 sf

B 495 sf

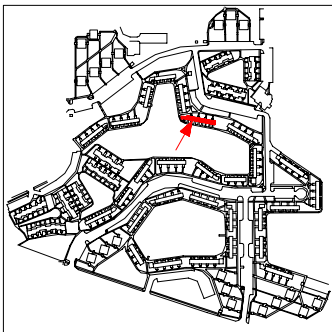

# Roof Corrective Action

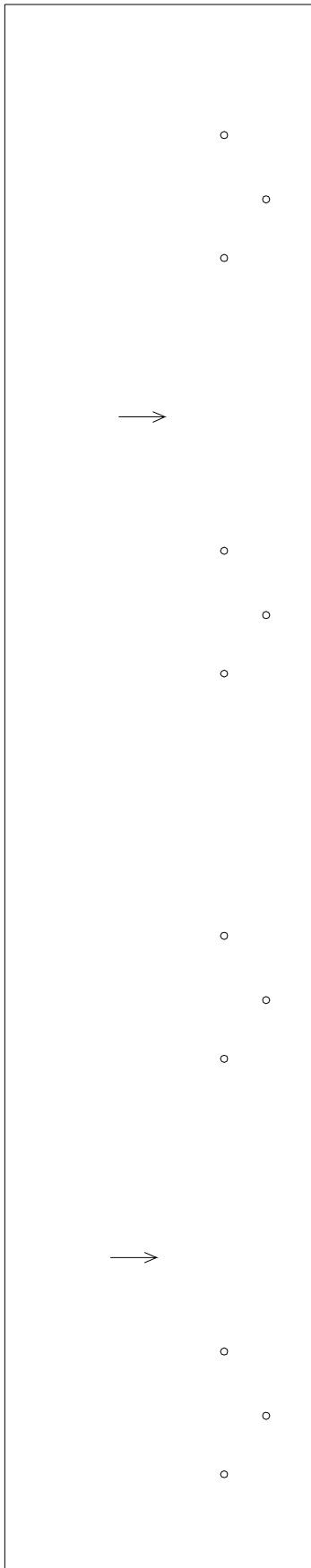
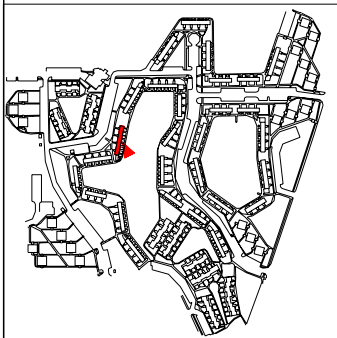

## SYMBOLS KEY

- VENT STACK
- Ⓢ DEFECT-REPAIR
- STRUCTURAL SLOPE

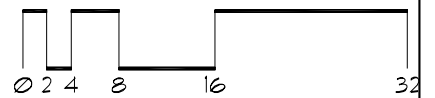

# Roof Corrective Action

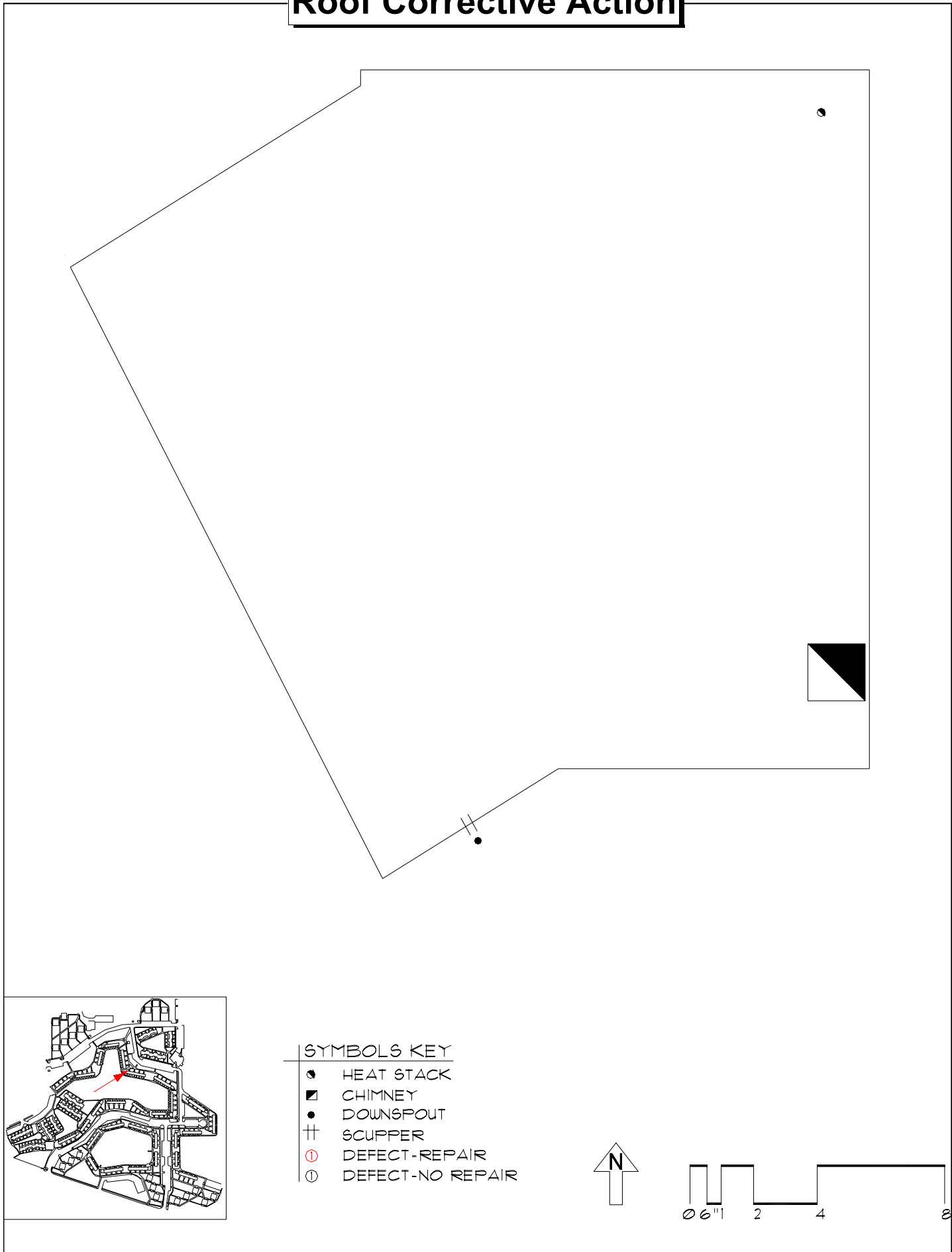



# Roof ID

Building: 17 - CT-17 - ()

Total Area: 4,764 sf

A 4,234 sf

B 530 sf

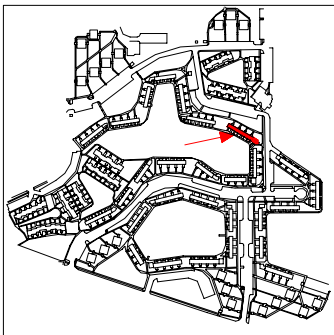
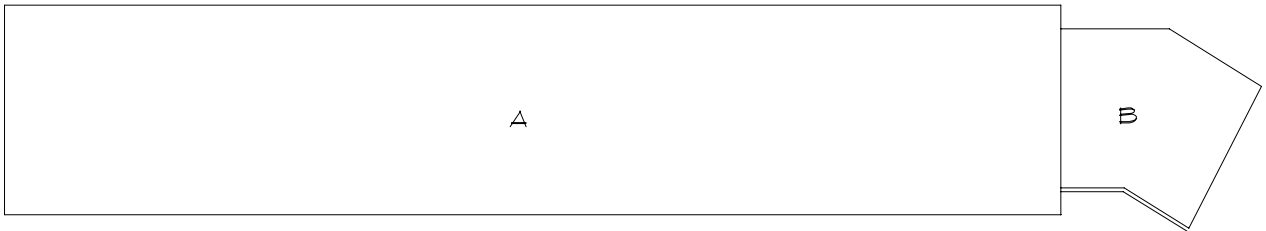

# Roof Corrective Action

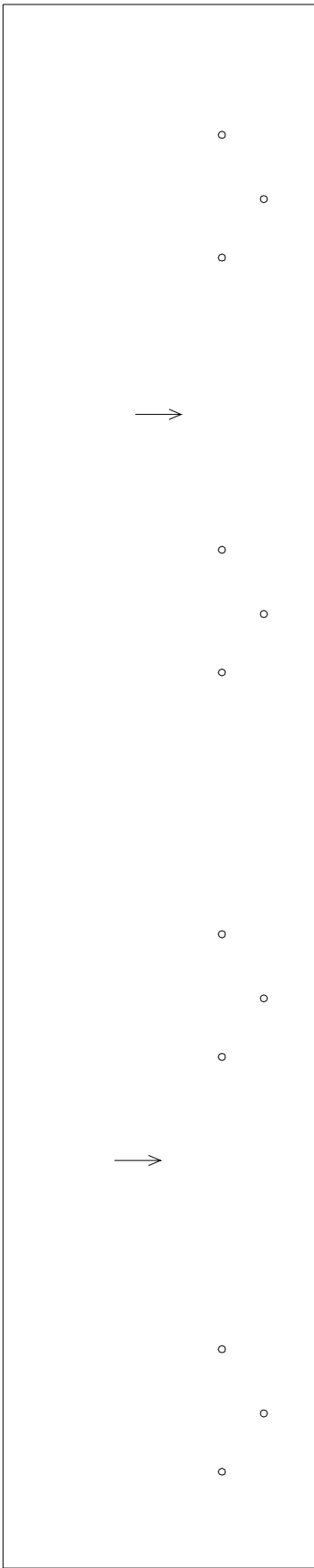

## SYMBOLS KEY

- VENT STACK
- Ⓢ DEFECT-REPAIR
- STRUCTURAL SLOPE

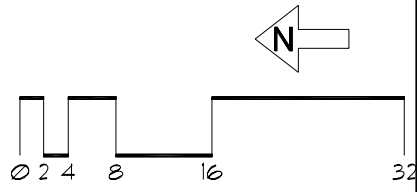
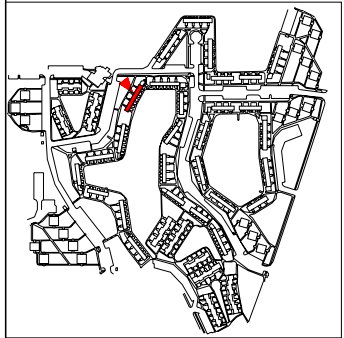

# Roof Corrective Action

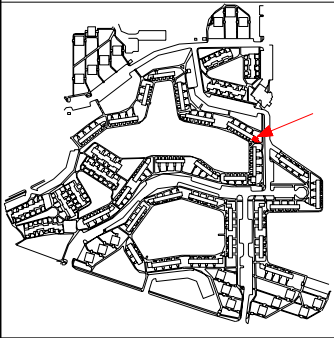
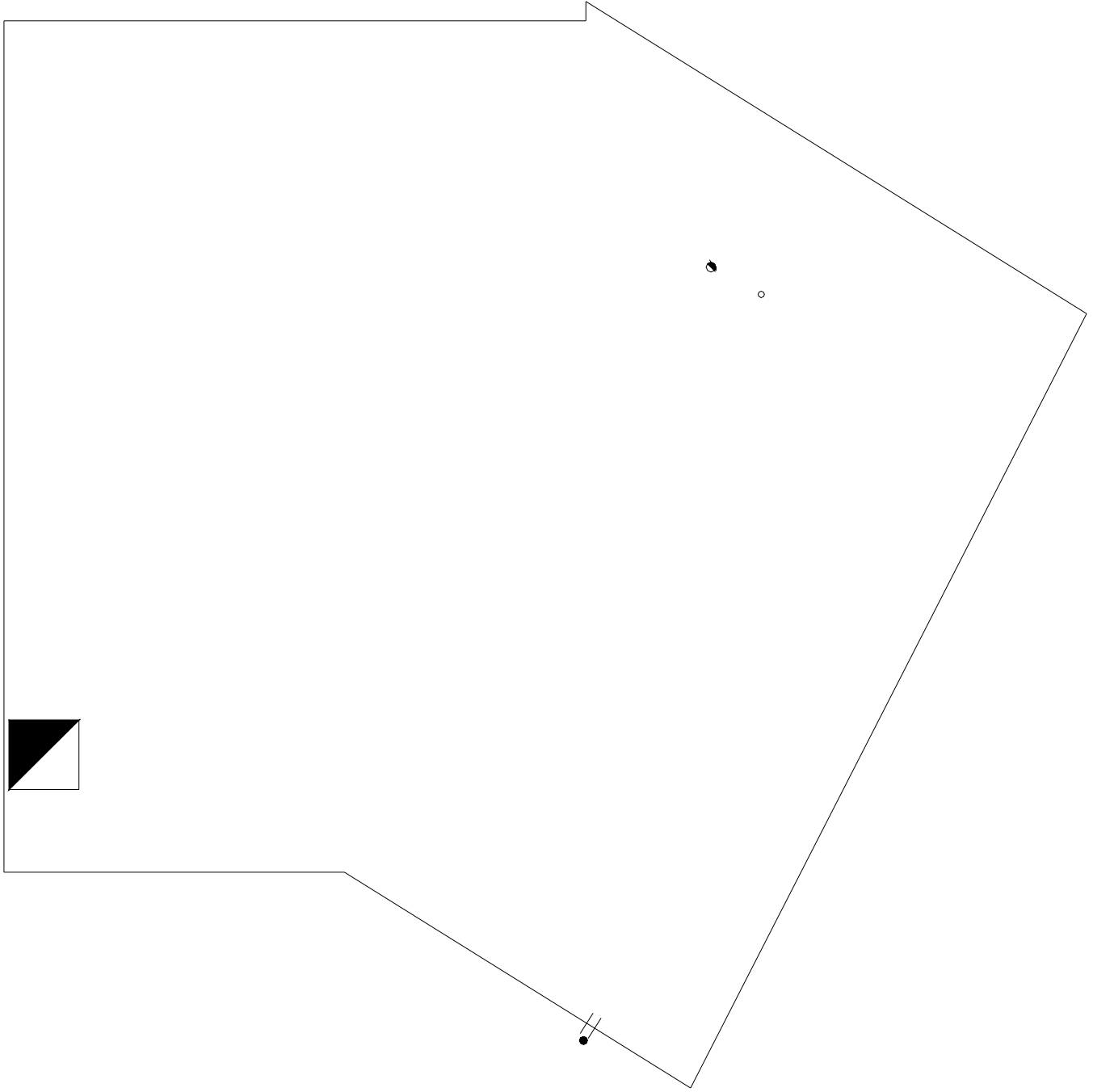

## SYMBOLS KEY

- VENT STACK
- ▣ CHIMNEY
- DOWNSPOUT
- † SCUPPER
- ◐ HEAT STACK
- DEFECT-REPAIR
- ① DEFECT-NO REPAIR

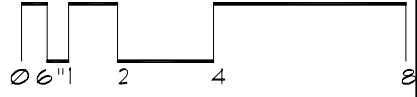
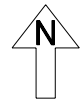

# Roof ID

Building: 18 - CT-18 - ()

Total Area: 5,246 sf

A 4,234 sf

B 1,012 sf

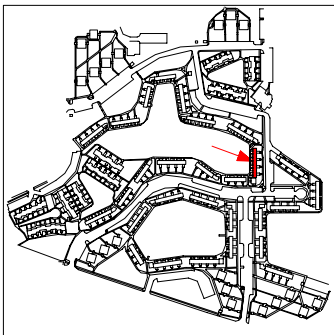
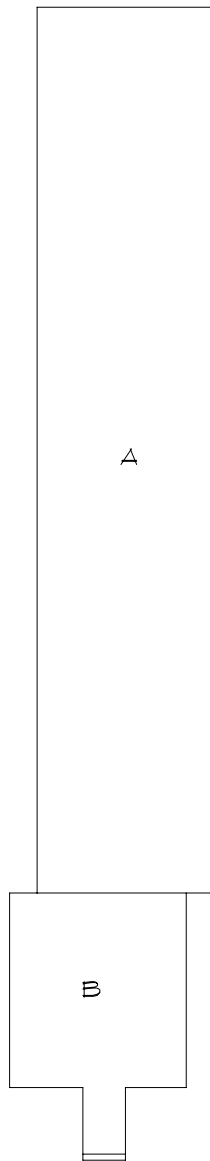

# Roof Corrective Action

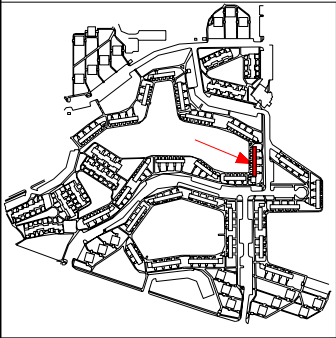
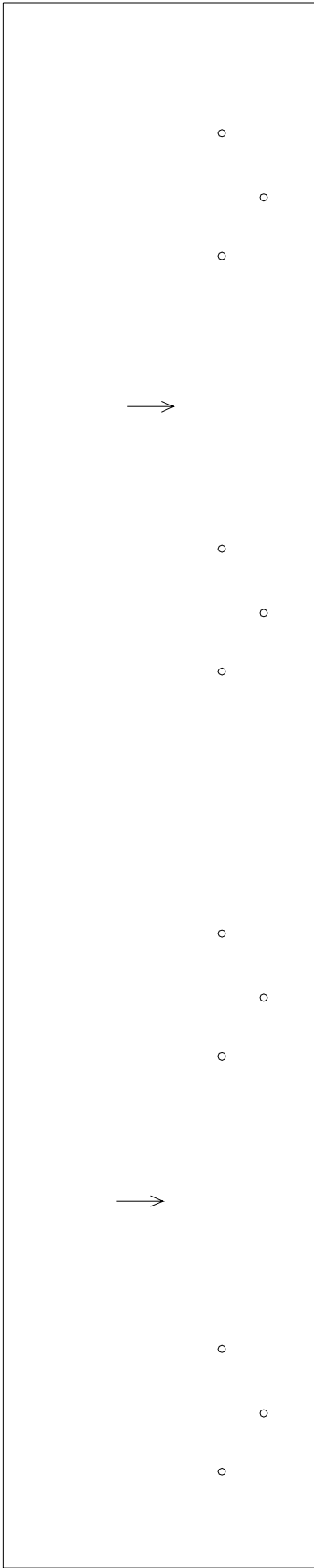

## SYMBOLS KEY

- VENT STACK
- STRUCTURAL SLOPE

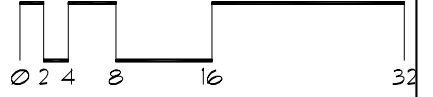

# Roof Corrective Action

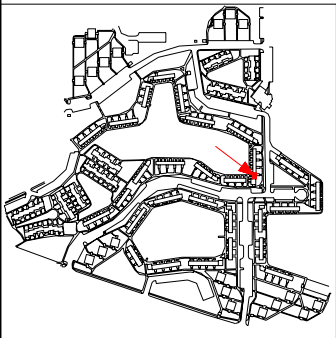
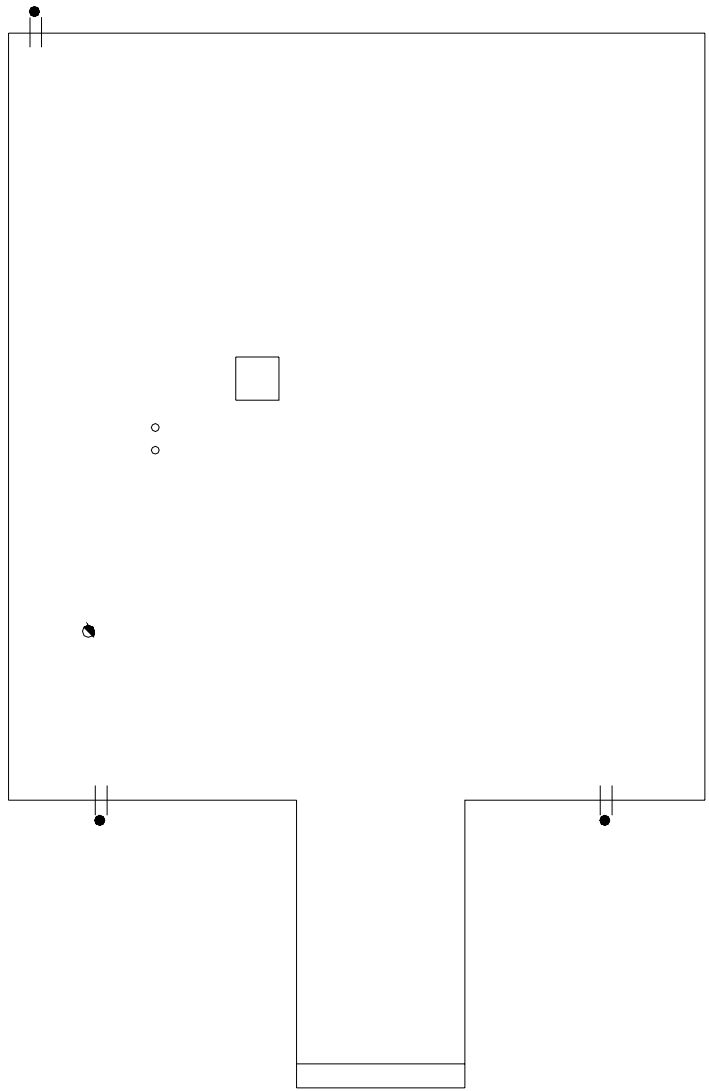

## SYMBOLS KEY

- ROOF CURB
- VENT STACK
- DOWNSPOUT
- ⊥ SCUPPER
- HEAT STACK
- ⊕ DEFECT-REPAIR
- ⊖ DEFECT-NO REPAIR

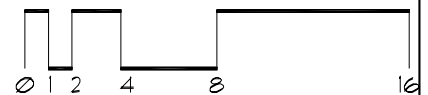

# Roof ID

Building: 19 - CT-19 - ()

Total Area: 3,190 sf

A 3,190 sf

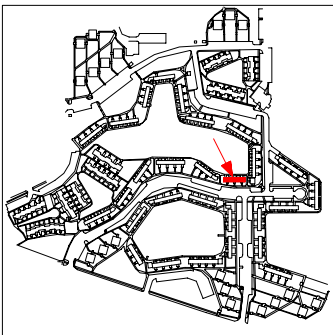
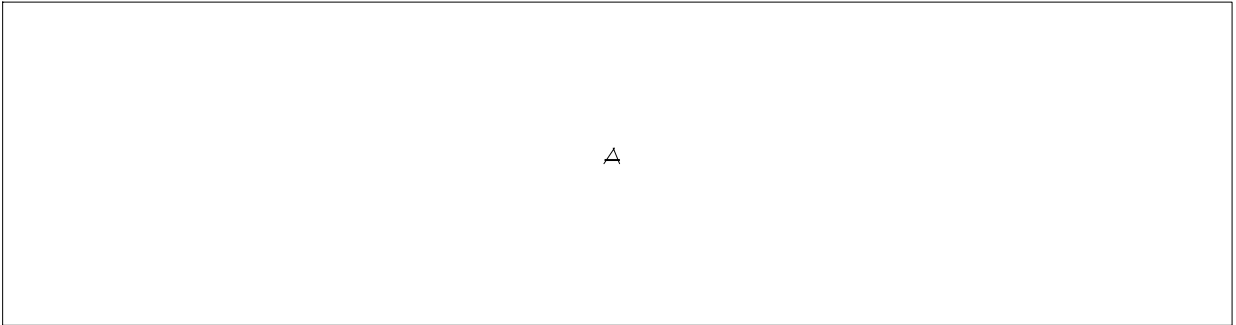

# Roof Corrective Action

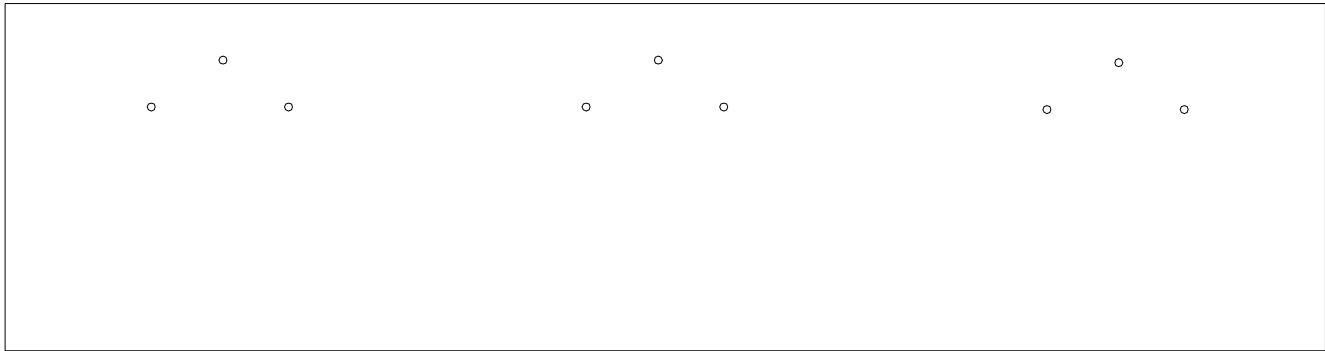

**SYMBOLS KEY**  
○ VENT STACK  
Ⓢ DEFECT-REPAIR

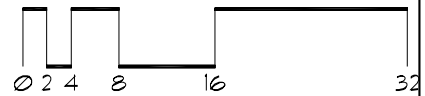



# Roof ID

Building: 20 - CT-20 - ()

Total Area: 3,733 sf

A 3,190 sf

B 543 sf

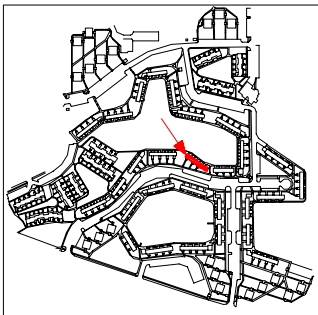
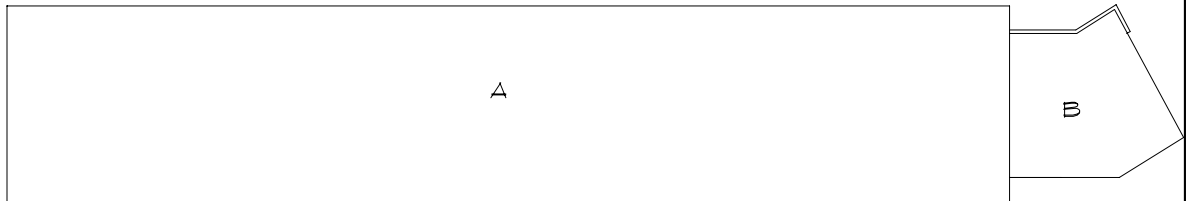

# Roof Corrective Action

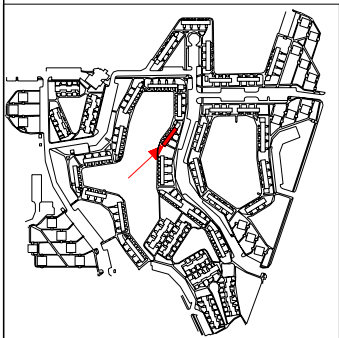
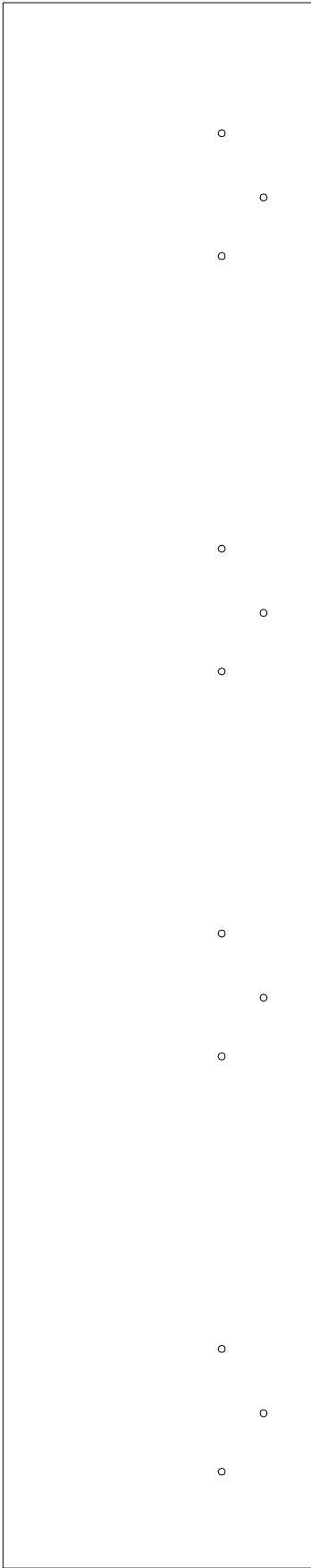

## SYMBOLS KEY

- VENT STACK
- Ⓜ DEFECT-REPAIR

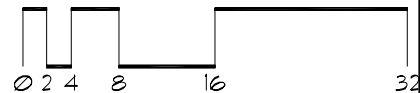

# Roof Corrective Action

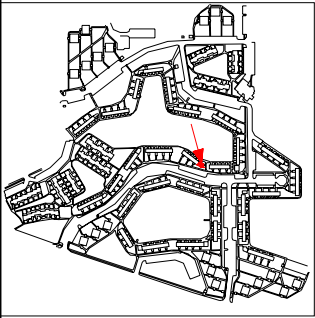
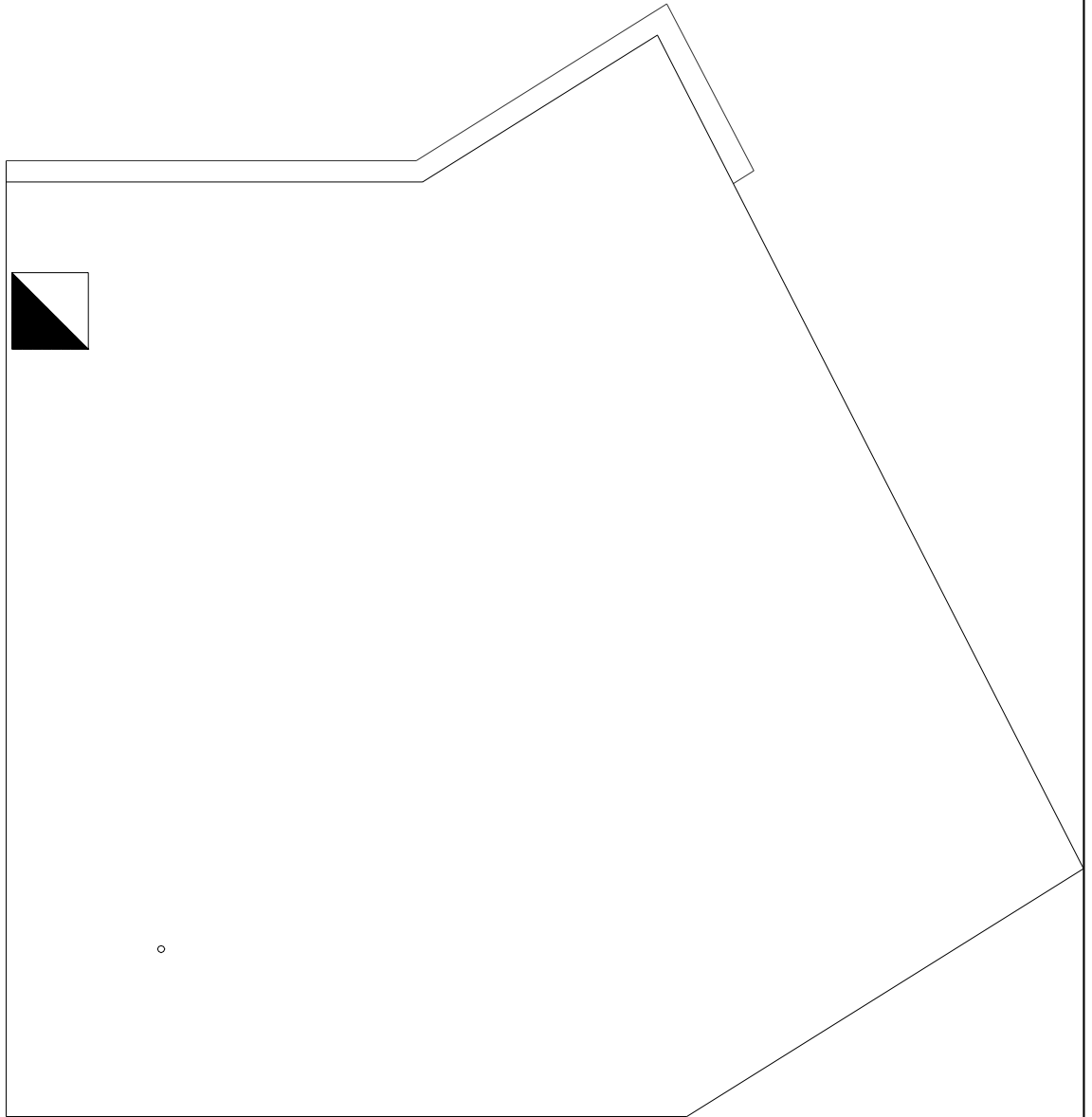

- SYMBOLS KEY**
- VENT STACK
  - ▴ CHIMNEY
  - ⊕ DEFECT-NO REPAIR

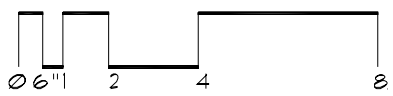

# Roof ID

Building: 21 - CT-21 - ()

Total Area: 4,234 sf

A 4,234 sf

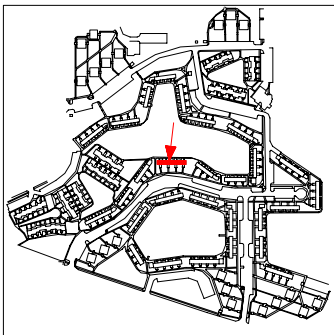
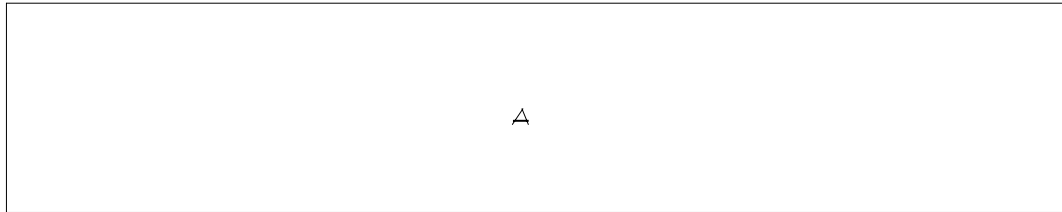



# Roof ID

Building: 22 - CT-22 - ()

Total Area: 3,733 sf

A 3,190 sf

B 543 sf

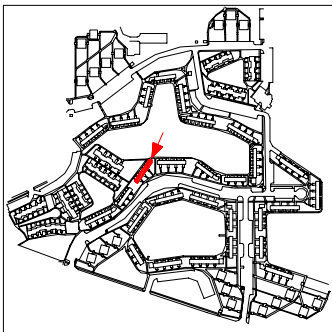
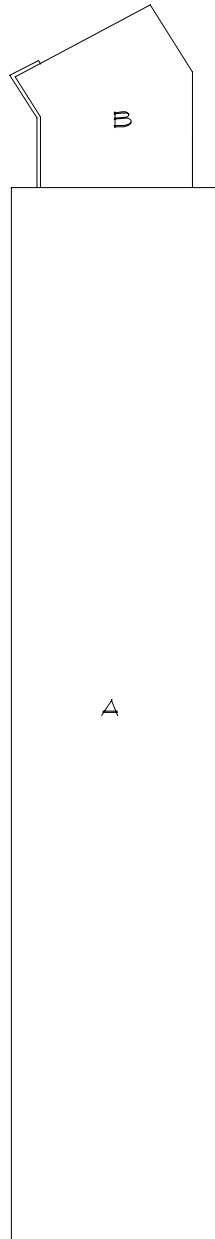

# Roof Corrective Action

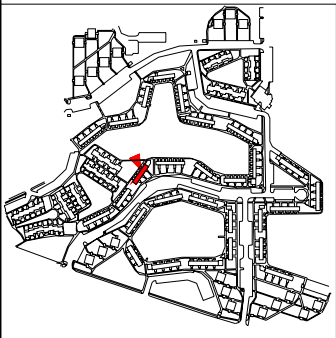
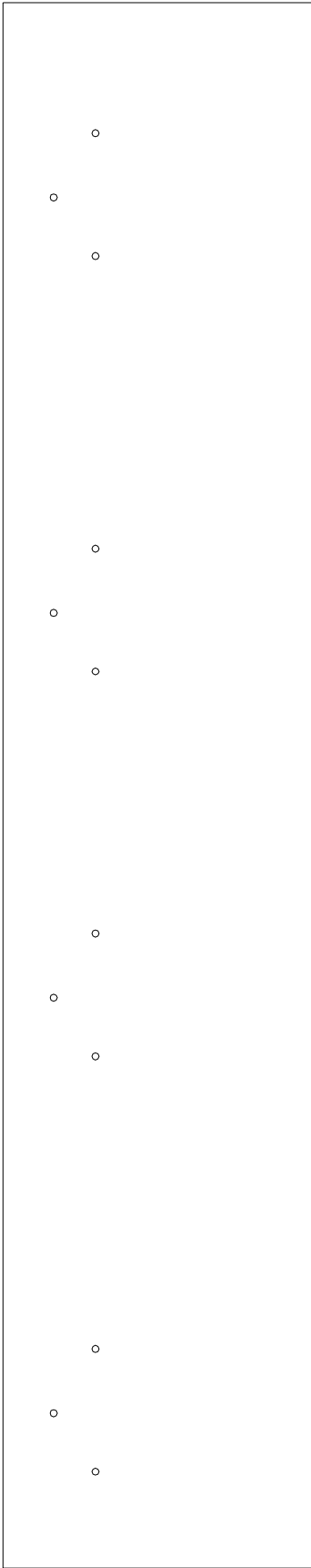

SYMBOLS KEY  
○ VENT STACK  
① DEFECT-REPAIR

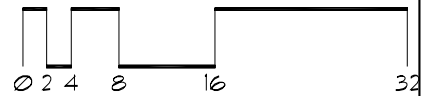

# Roof Corrective Action

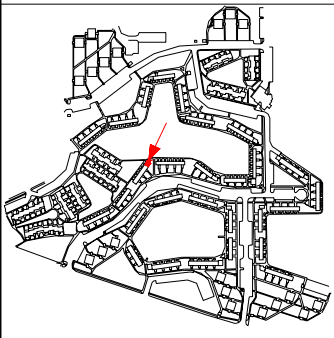
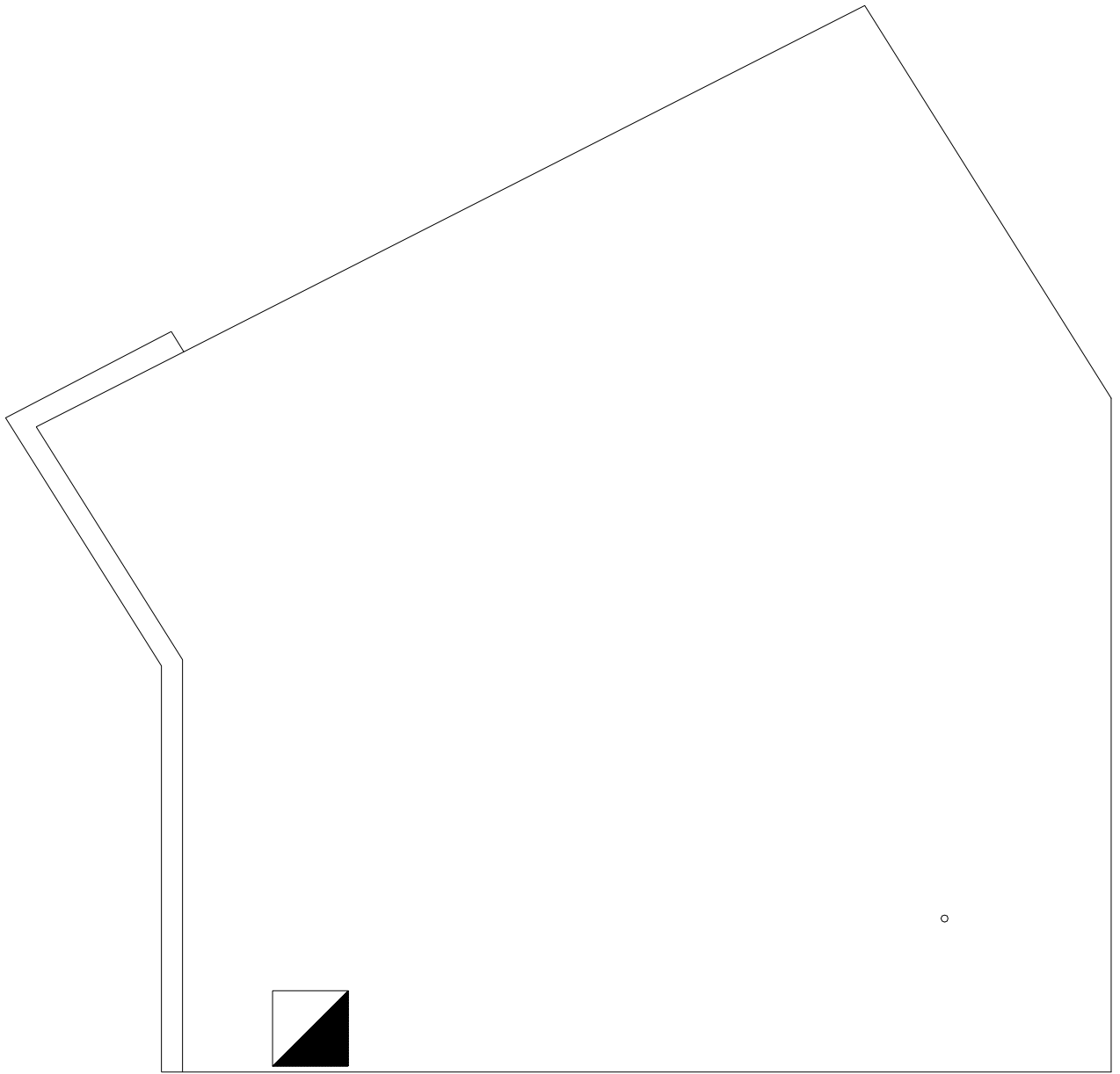

## SYMBOLS KEY

- VENT STACK
- ◻ CHIMNEY DEFECT-REPAIR

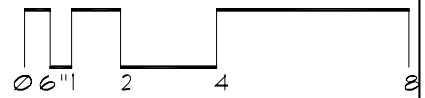



# Roof ID

Building: 23 - CT-23 - ()

Total Area: 3,190 sf

A 3,190 sf

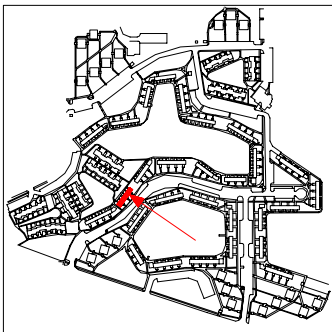
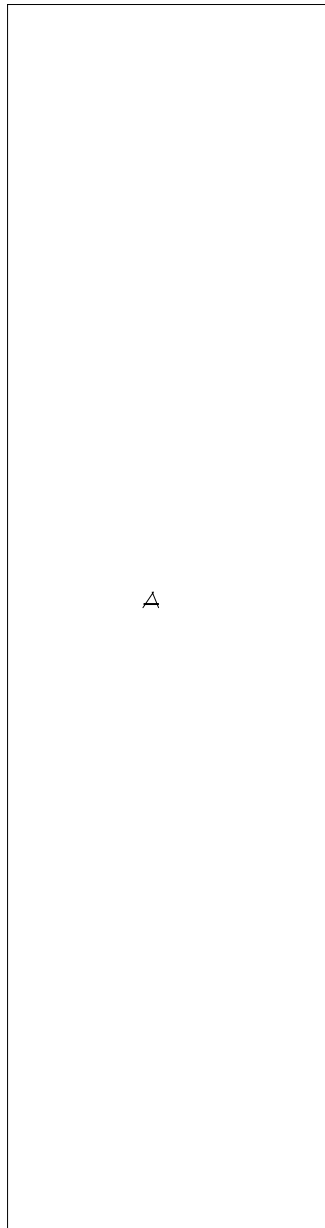

# Roof Corrective Action

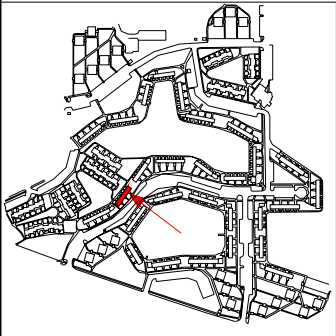
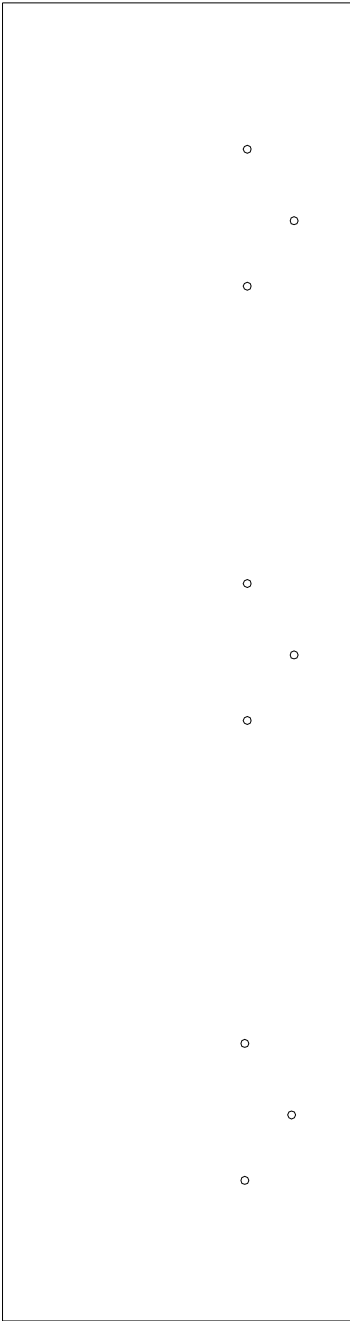

SYMBOLS KEY  
○ VENT STACK  
① DEFECT-REPAIR

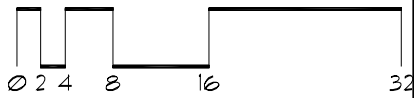
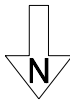

# Roof ID

Building: 24 - CT-24 - ()

Total Area: 4,777 sf

A 4,234 sf

B 543 sf

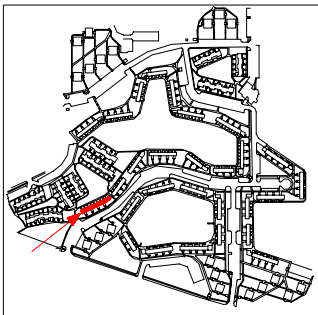

# Roof Corrective Action

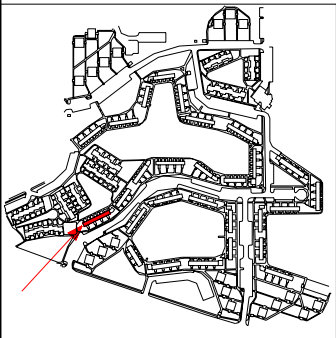
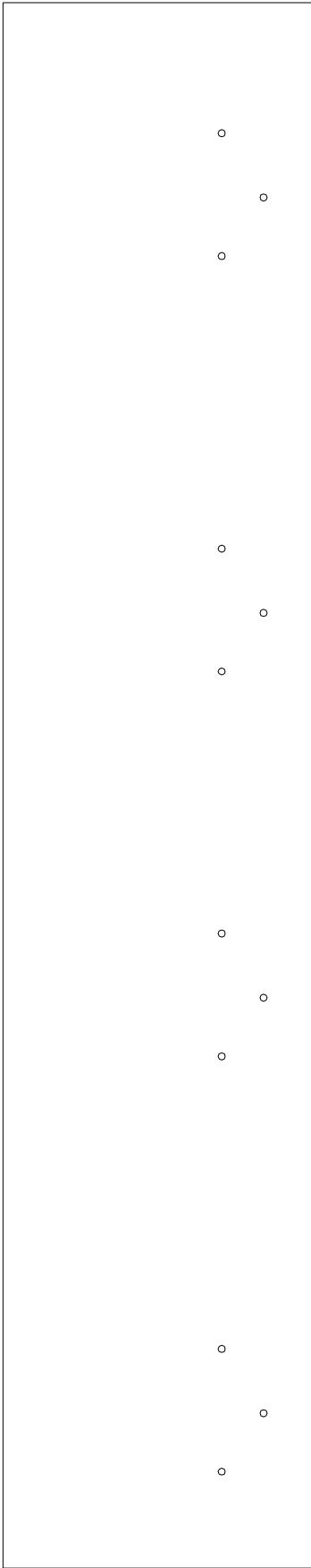

## SYMBOLS KEY

○ VENT STACK  
DEFECT-REPAIR

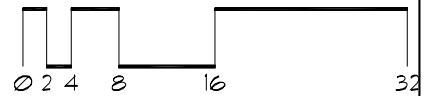

# Roof Corrective Action

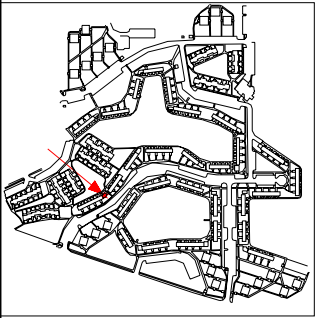
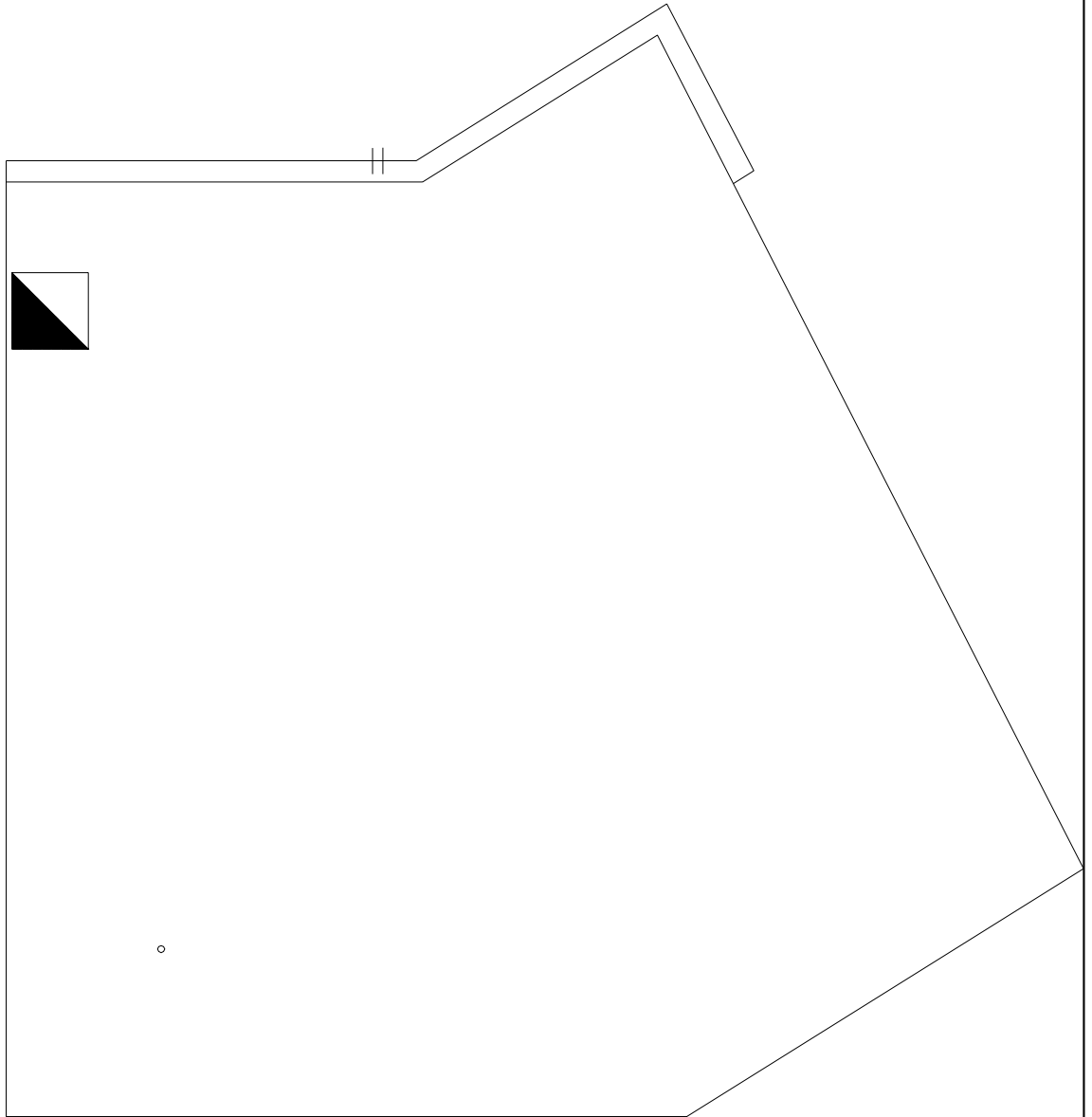

## SYMBOLS KEY

- VENT STACK
- ▴ CHIMNEY
- ⊖ DEFECT-REPAIR
- || SCUPPER

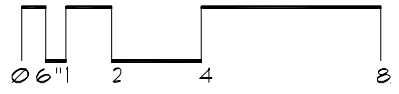

# Roof ID

Building: 25 - CT-25 - ()

Total Area: 2,650 sf

A 2,650 sf

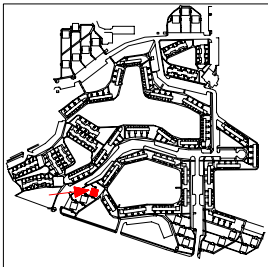
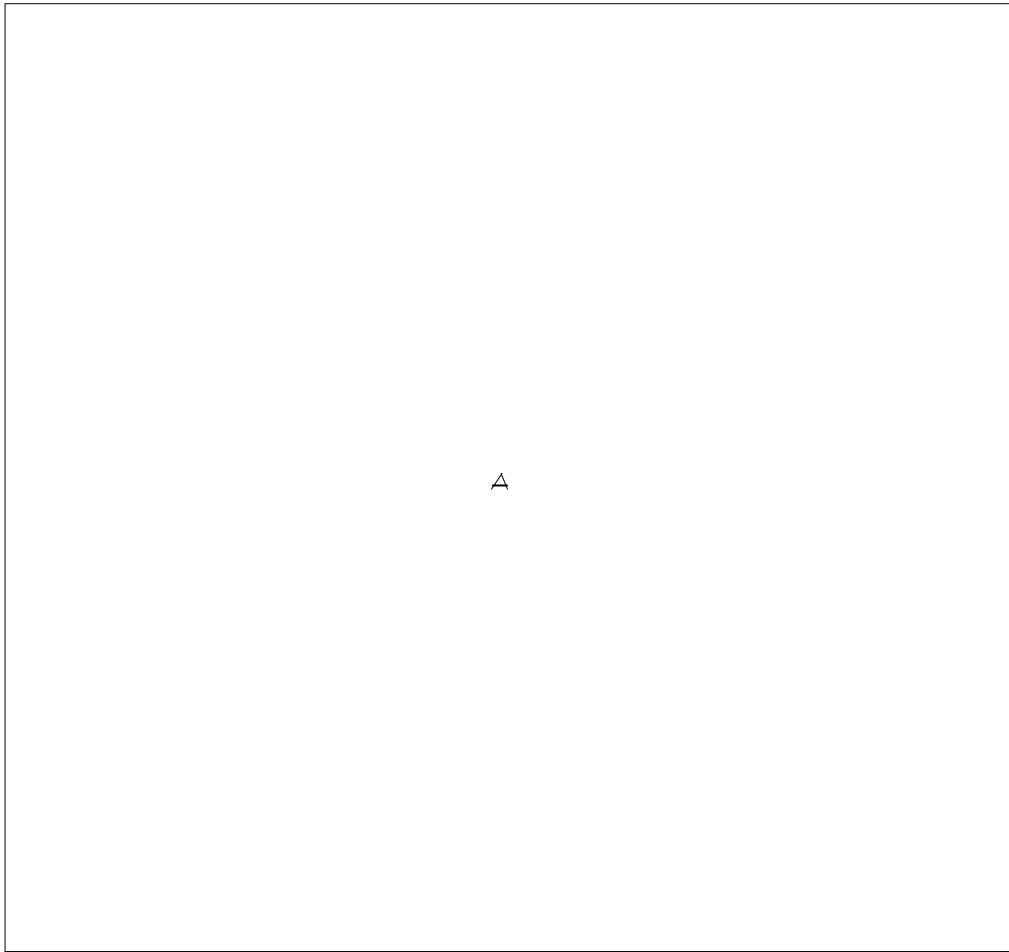

# Roof Corrective Action

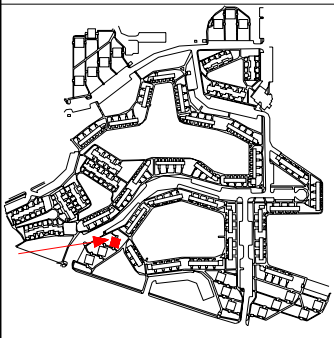
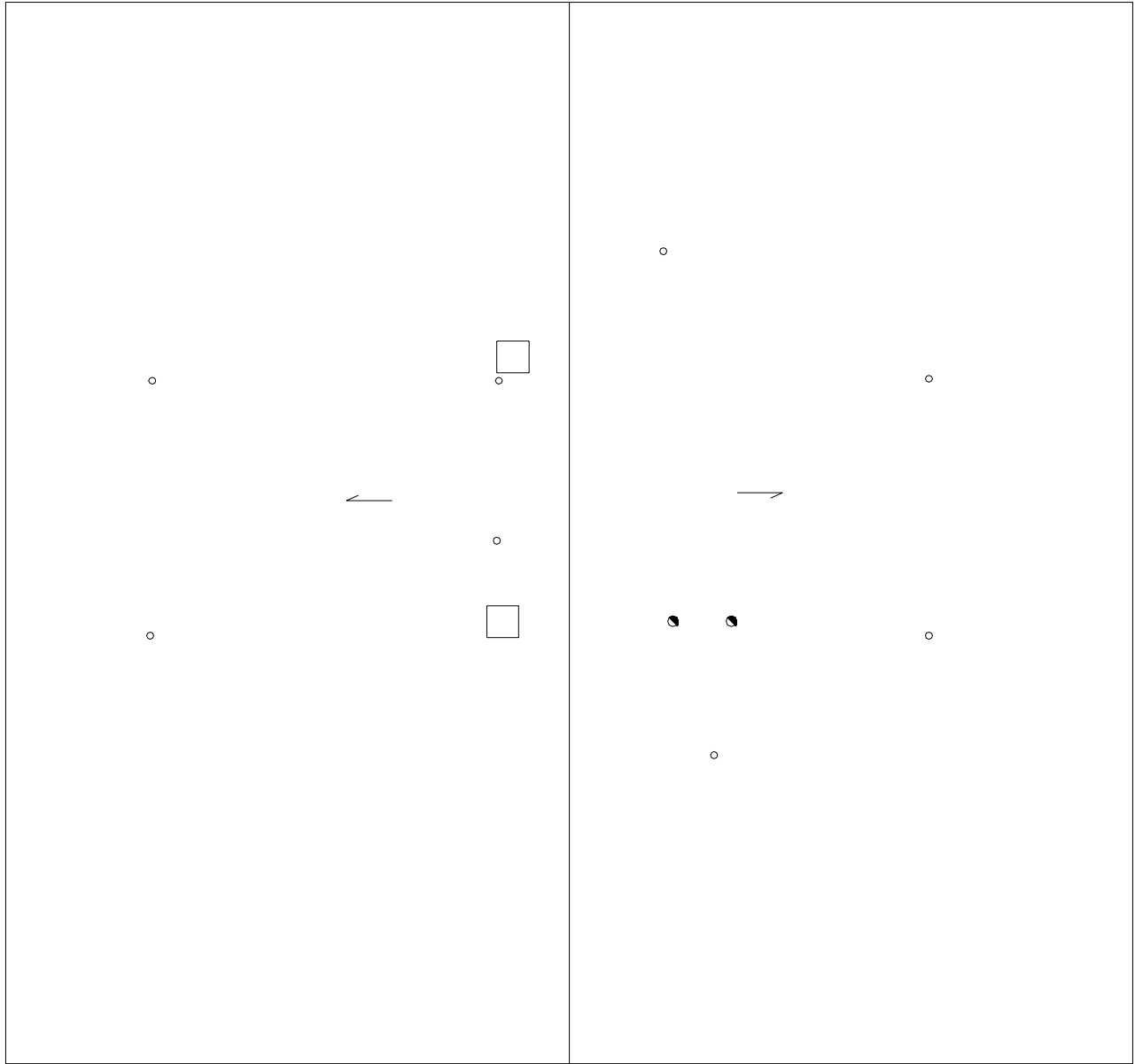

- SYMBOLS KEY**
- ROOF CURB
  - VENT STACK
  - SLOPE DIRECTION
  - HEAT STACK
  - Ⓢ DEFECT-REPAIR

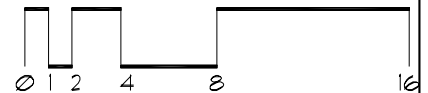

# Roof ID

Building: 26 - CT-26 - ()

Total Area: 2,650 sf

A 2,650 sf

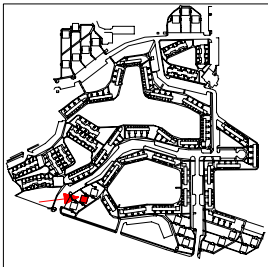
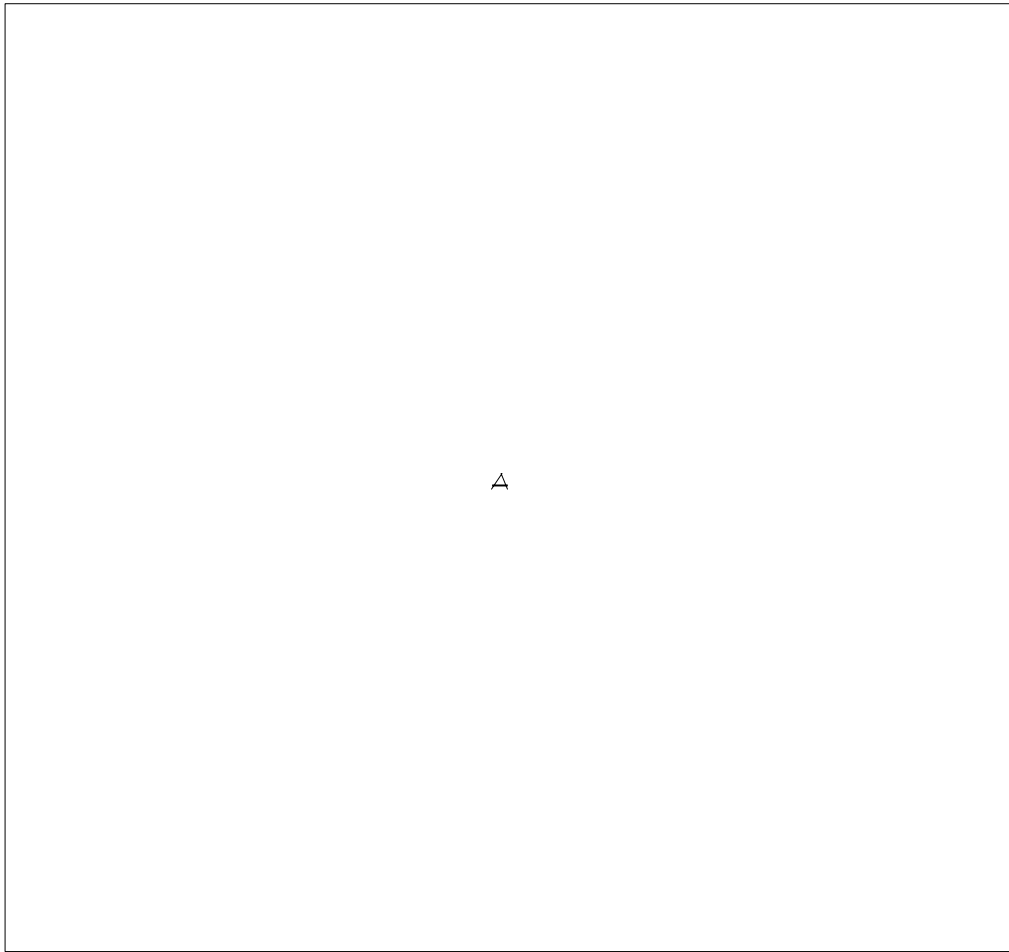



# Roof Corrective Action

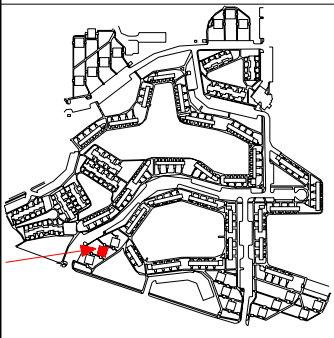
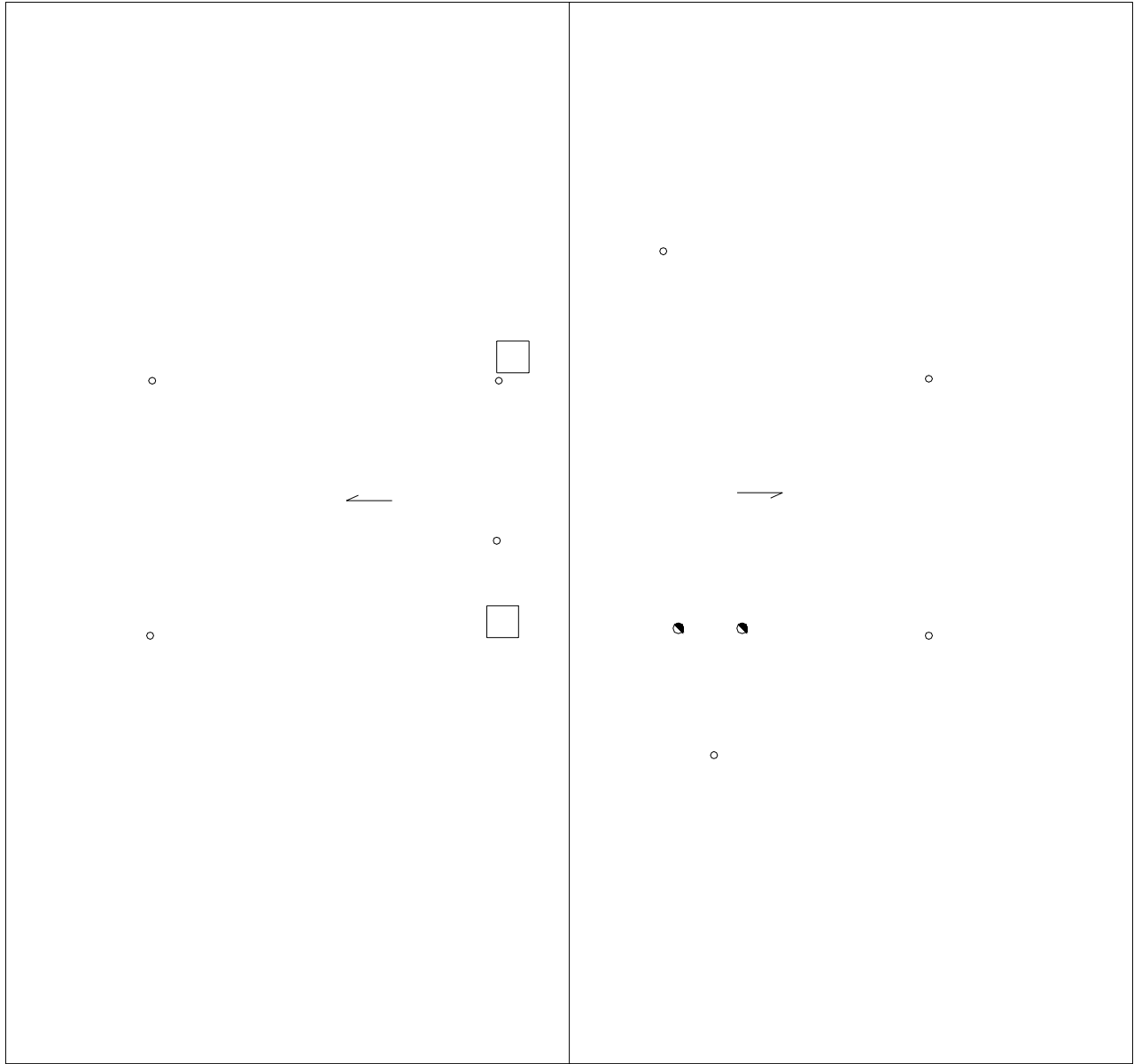

## SYMBOLS KEY

- ROOF CURB
- VENT STACK
- SLOPE DIRECTION
- HEAT STACK
- Ⓢ DEFECT-REPAIR

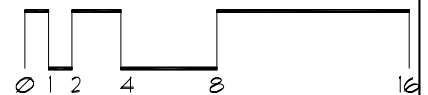

# Roof ID

Building: 27 - CT-27 - ()

Total Area: 2,650 sf

A 2,650 sf

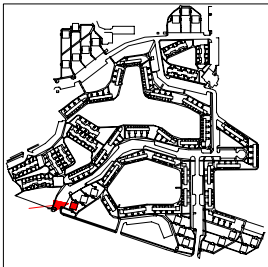
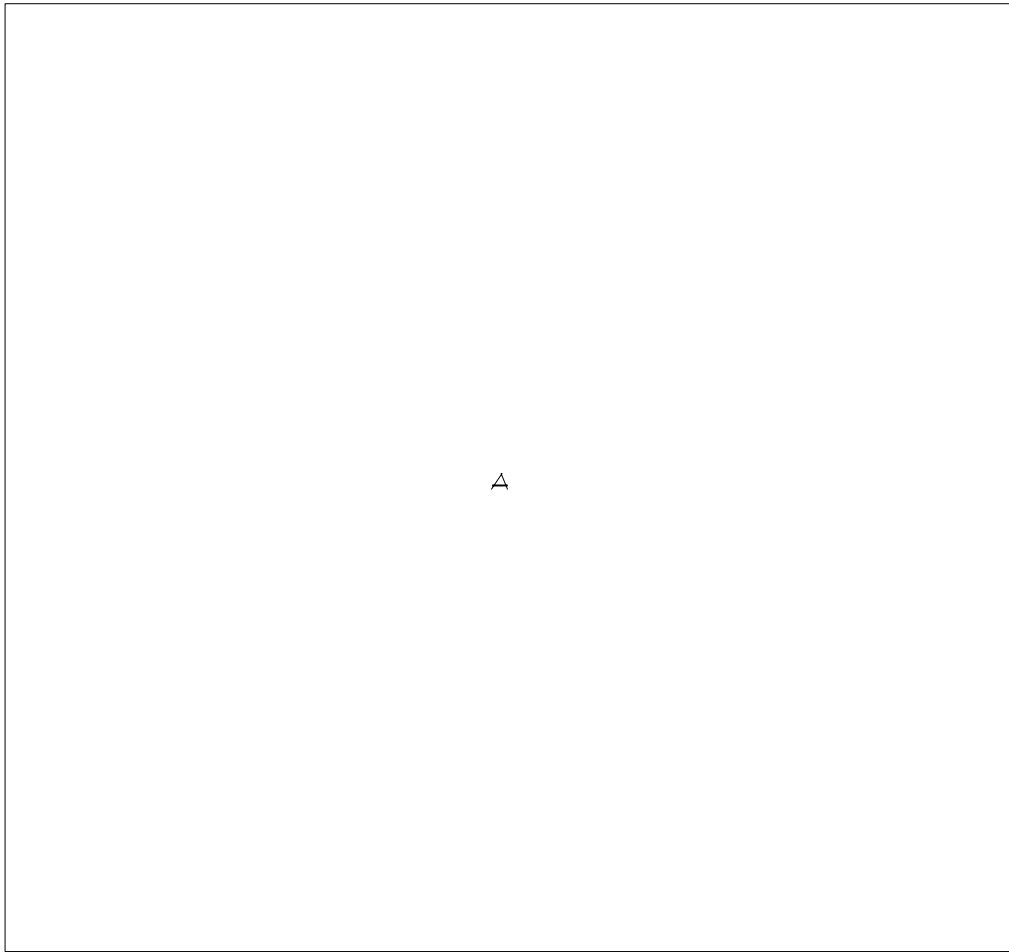

# Roof Corrective Action

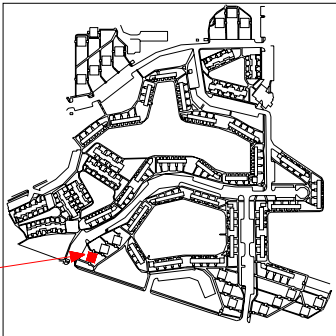
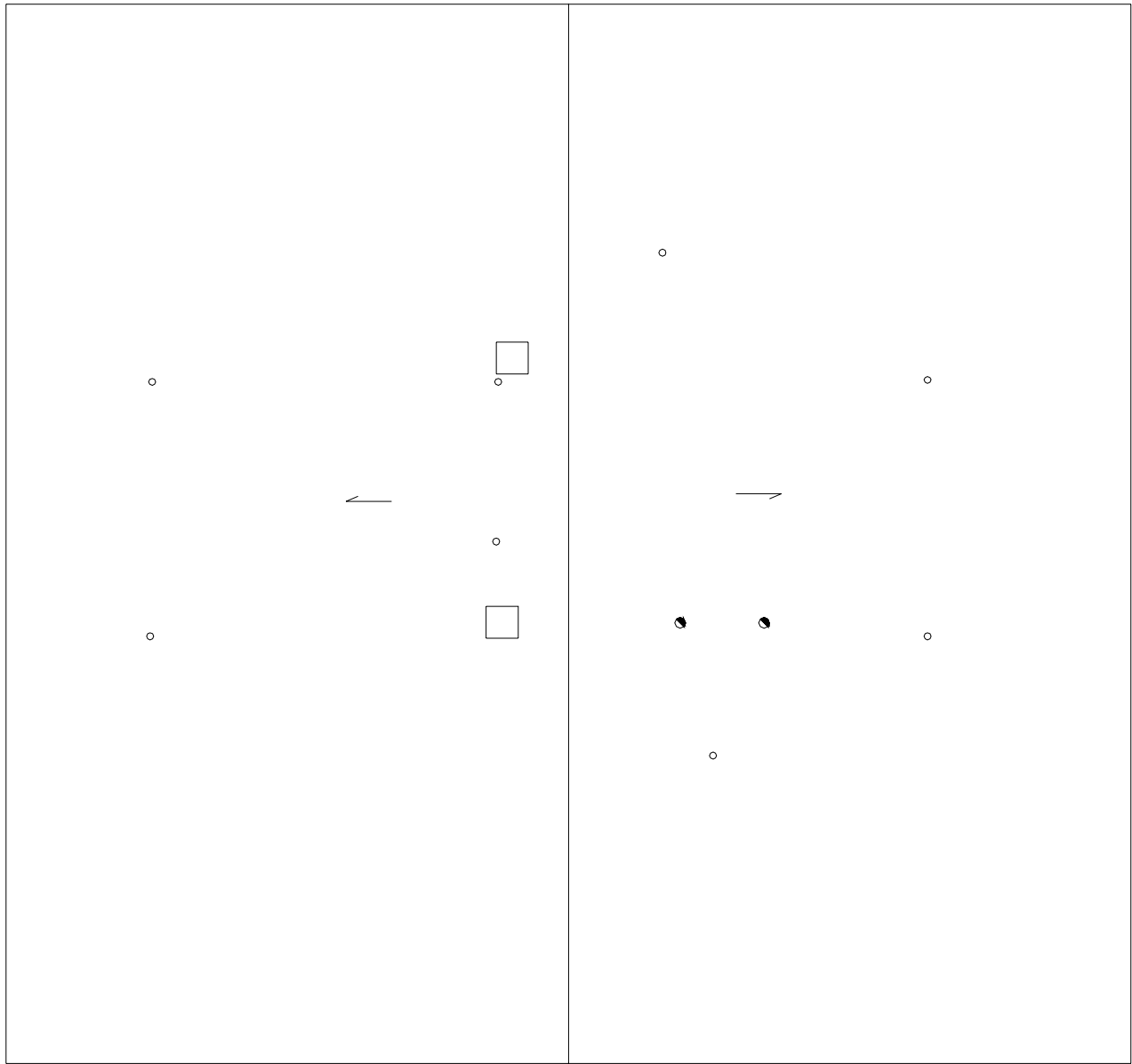

## SYMBOLS KEY

- ROOF CURB
- VENT STACK
- SLOPE DIRECTION
- HEAT STACK
- ⊖ DEFECT-REPAIR

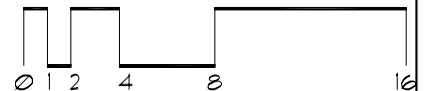

# Roof ID

Building: 28 - CT-28 - ()

Total Area: 2,650 sf

A 2,650 sf

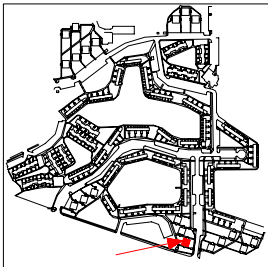
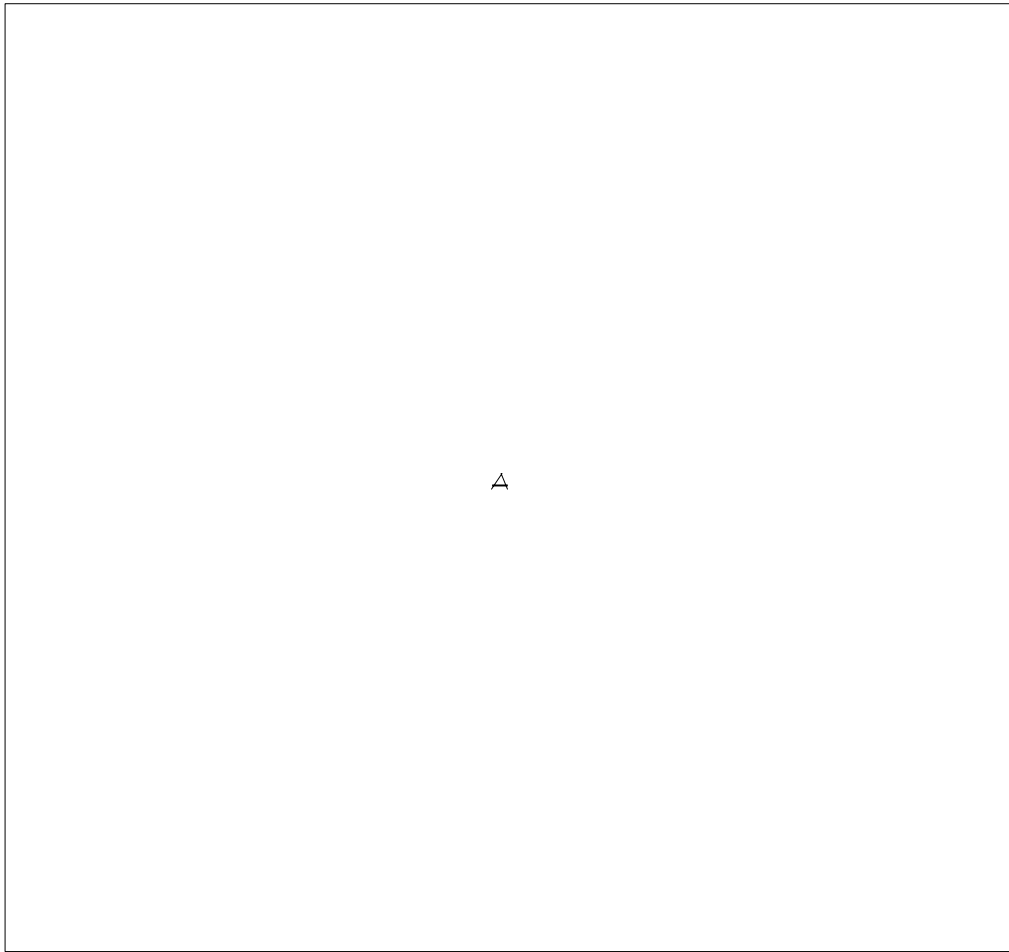

# Roof Corrective Action

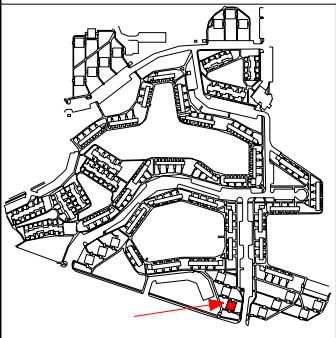
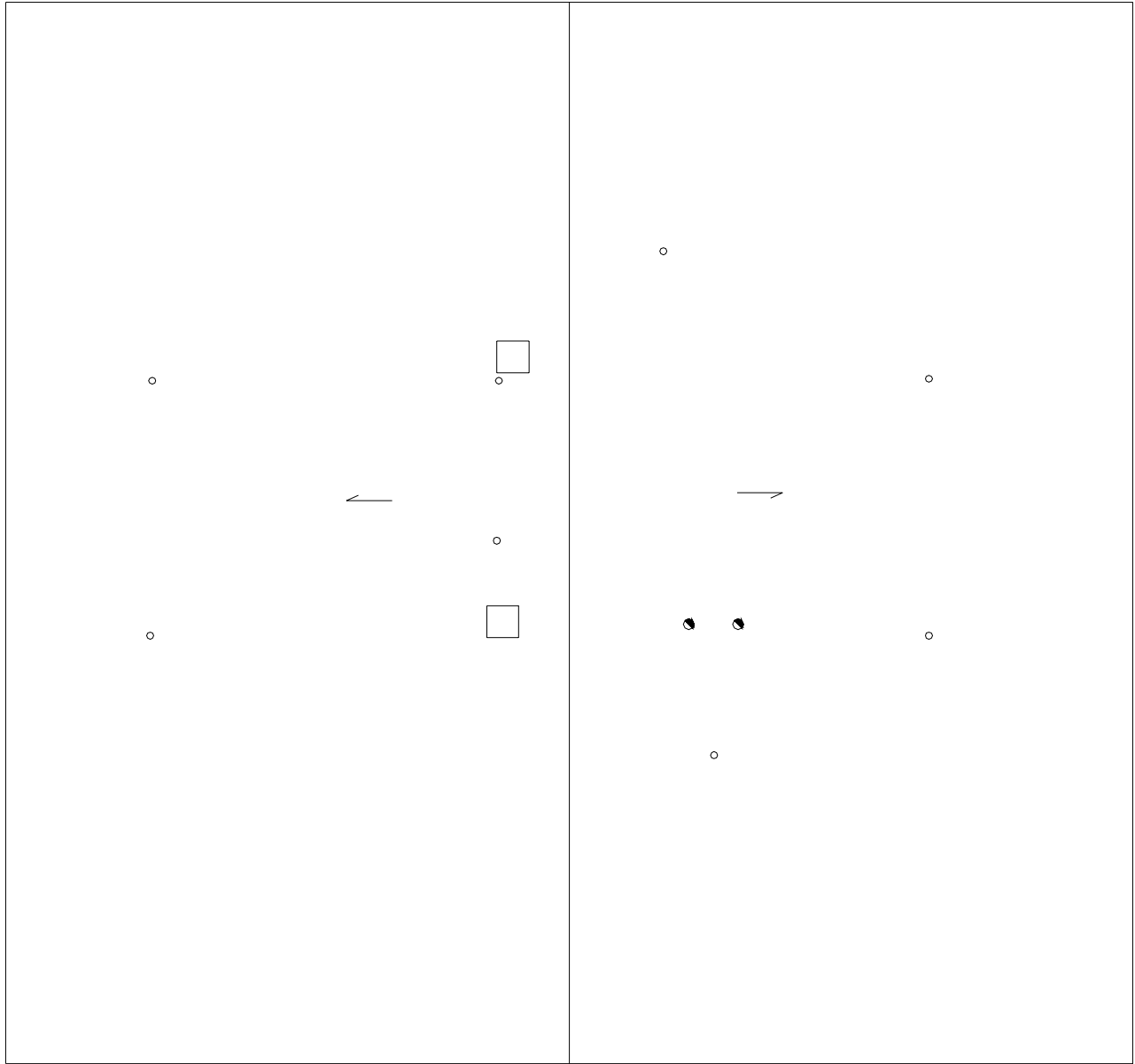

- SYMBOLS KEY**
- ROOF CURB
  - VENT STACK
  - SLOPE DIRECTION
  - HEAT STACK

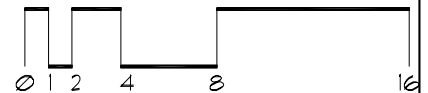

# Roof ID

Building: 29 - CT-29 - ()

Total Area: 2,650 sf

A 2,650 sf

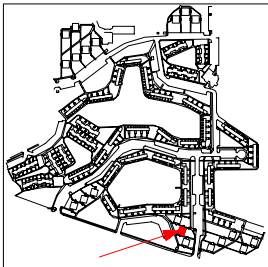
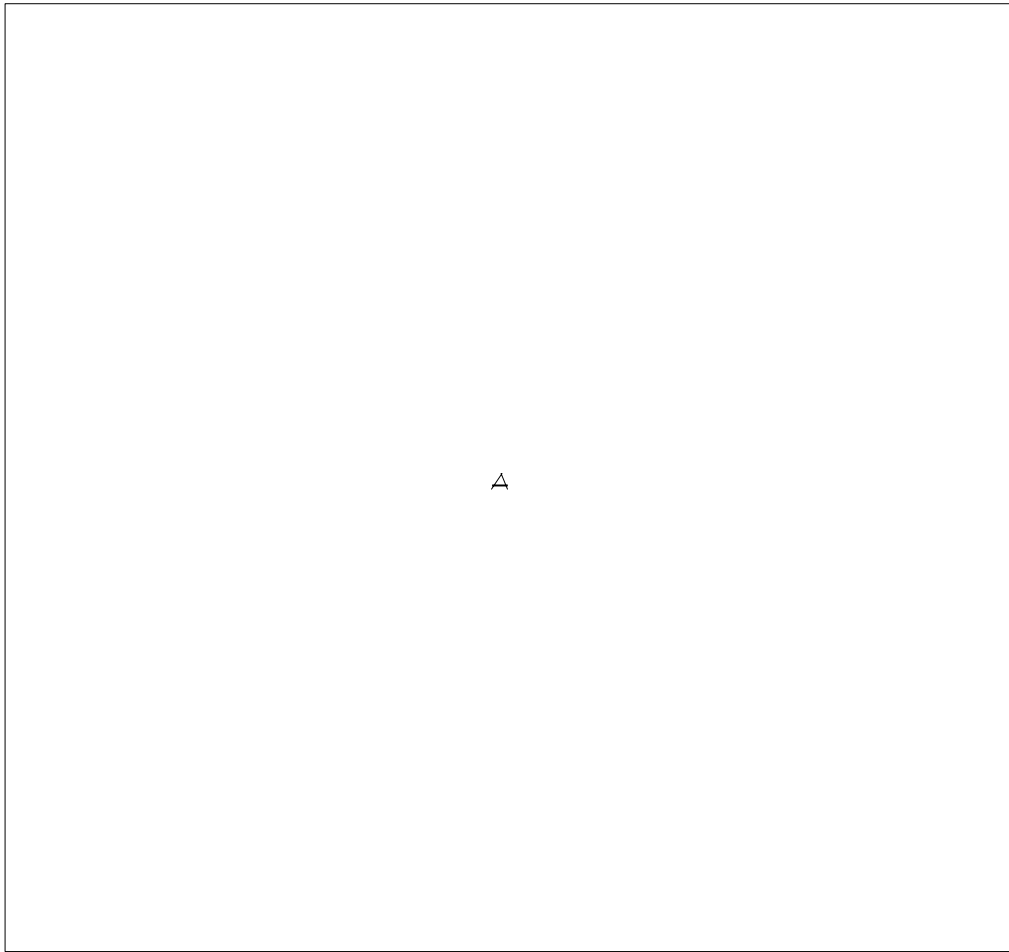

# Roof Corrective Action

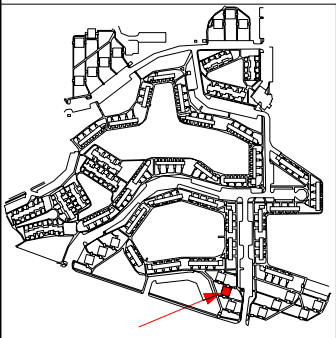
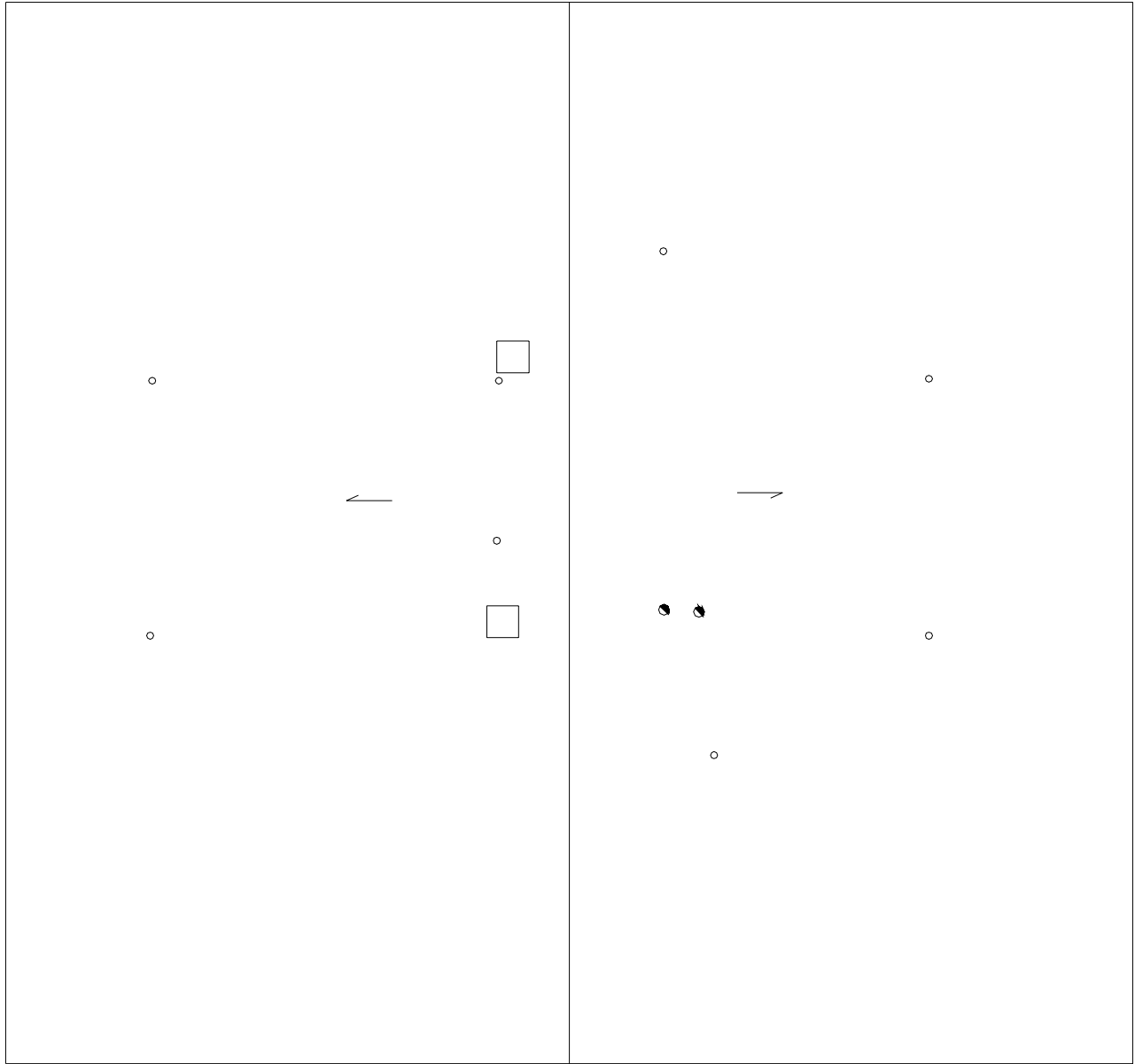

- SYMBOLS KEY**
- ROOF CURB
  - VENT STACK
  - SLOPE DIRECTION
  - HEAT STACK
  - Ⓢ DEFECT-REPAIR

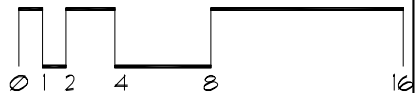
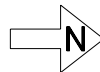

# Roof ID

Building: 30 - CT-30 - ()

Total Area: 2,650 sf

A 2,650 sf

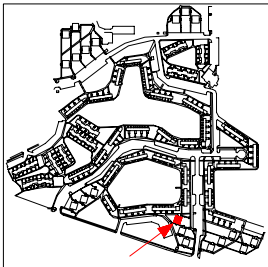
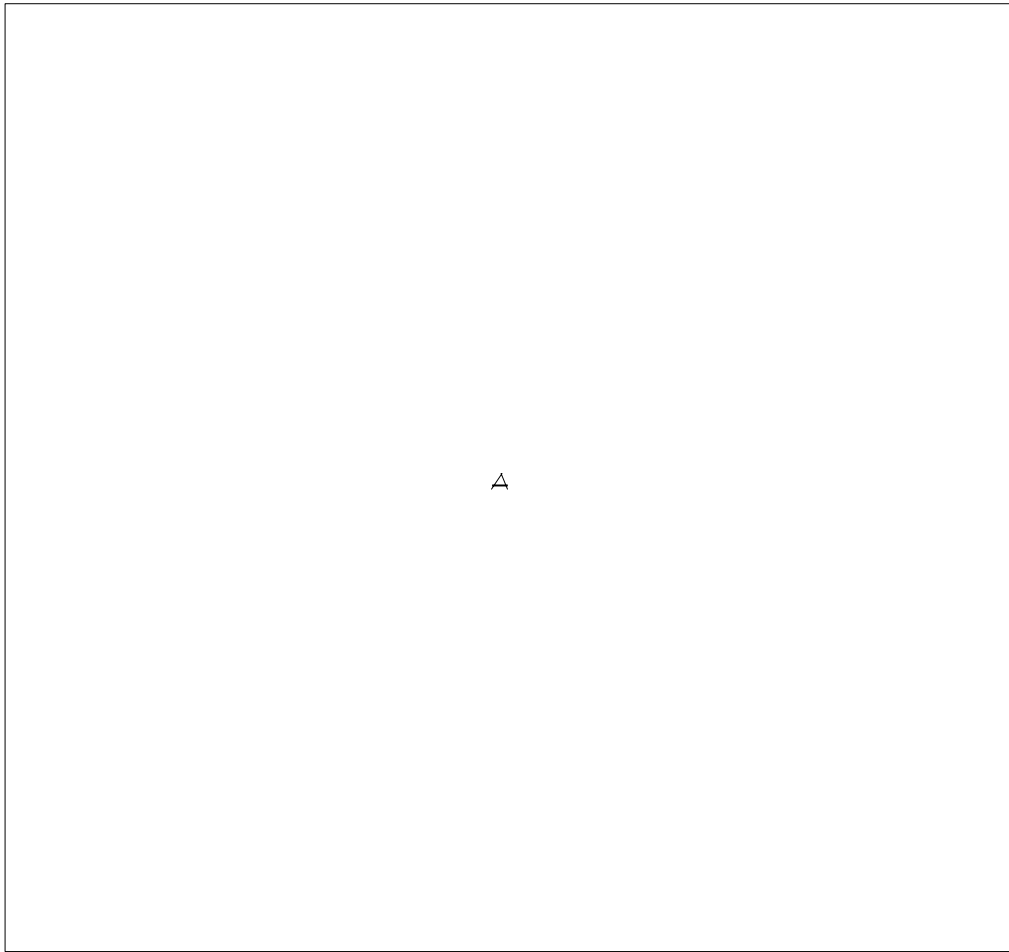



# Roof Corrective Action

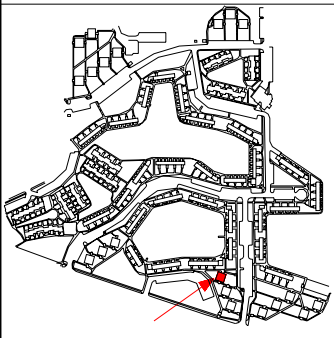
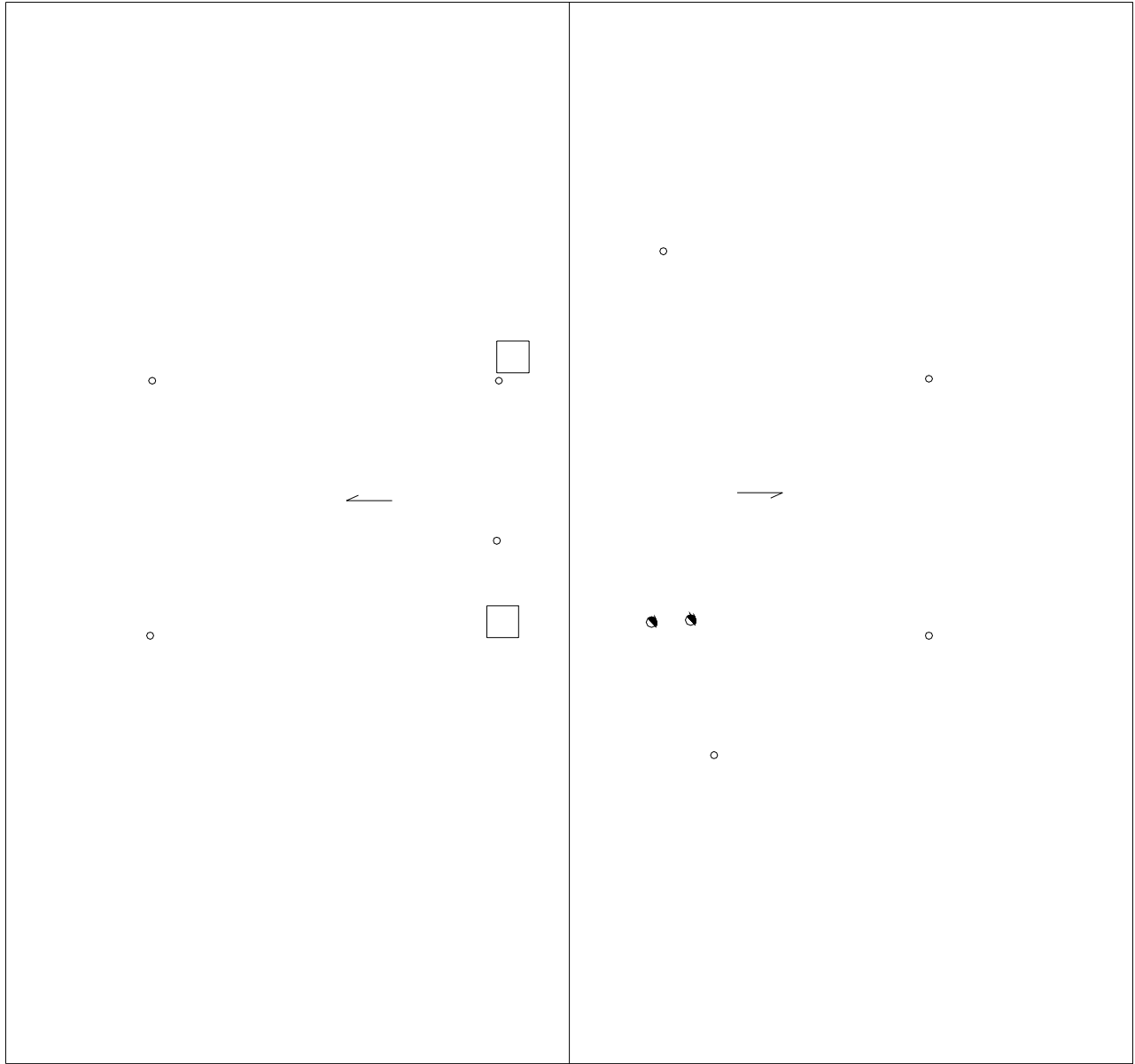

**SYMBOLS KEY**

- ROOF CURB
- VENT STACK
- SLOPE DIRECTION
- HEAT STACK
- Ⓜ DEFECT-REPAIR

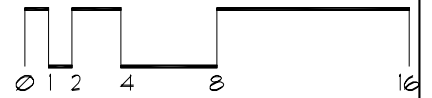
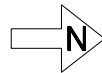

# Roof ID

Building: 31 - CT-31 - ()

Total Area: 4,872 sf

A 4,234 sf

B 638 sf

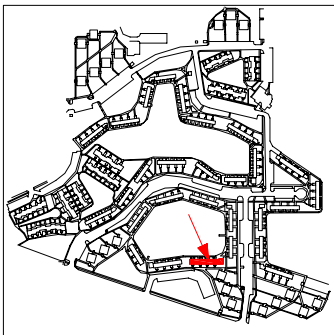
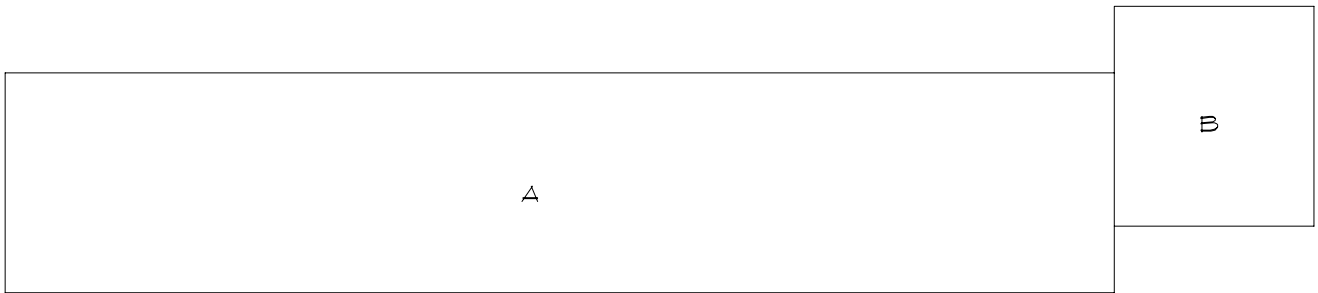

# Roof Corrective Action

## SYMBOLS KEY

- VENT STACK
- Ⓢ DEFECT-REPAIR
- STRUCTURAL SLOPE

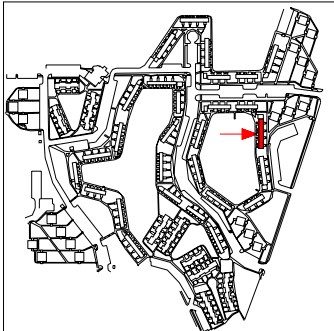
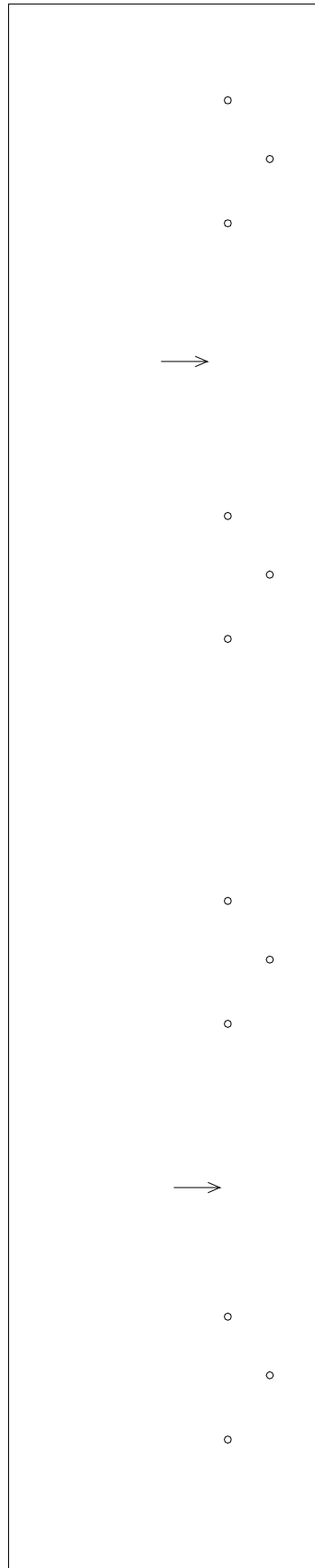

# Roof Corrective Action

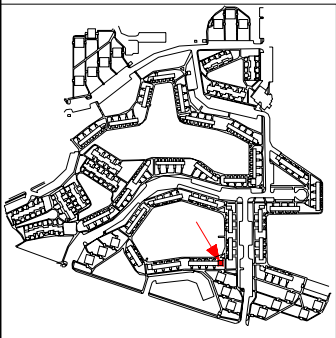
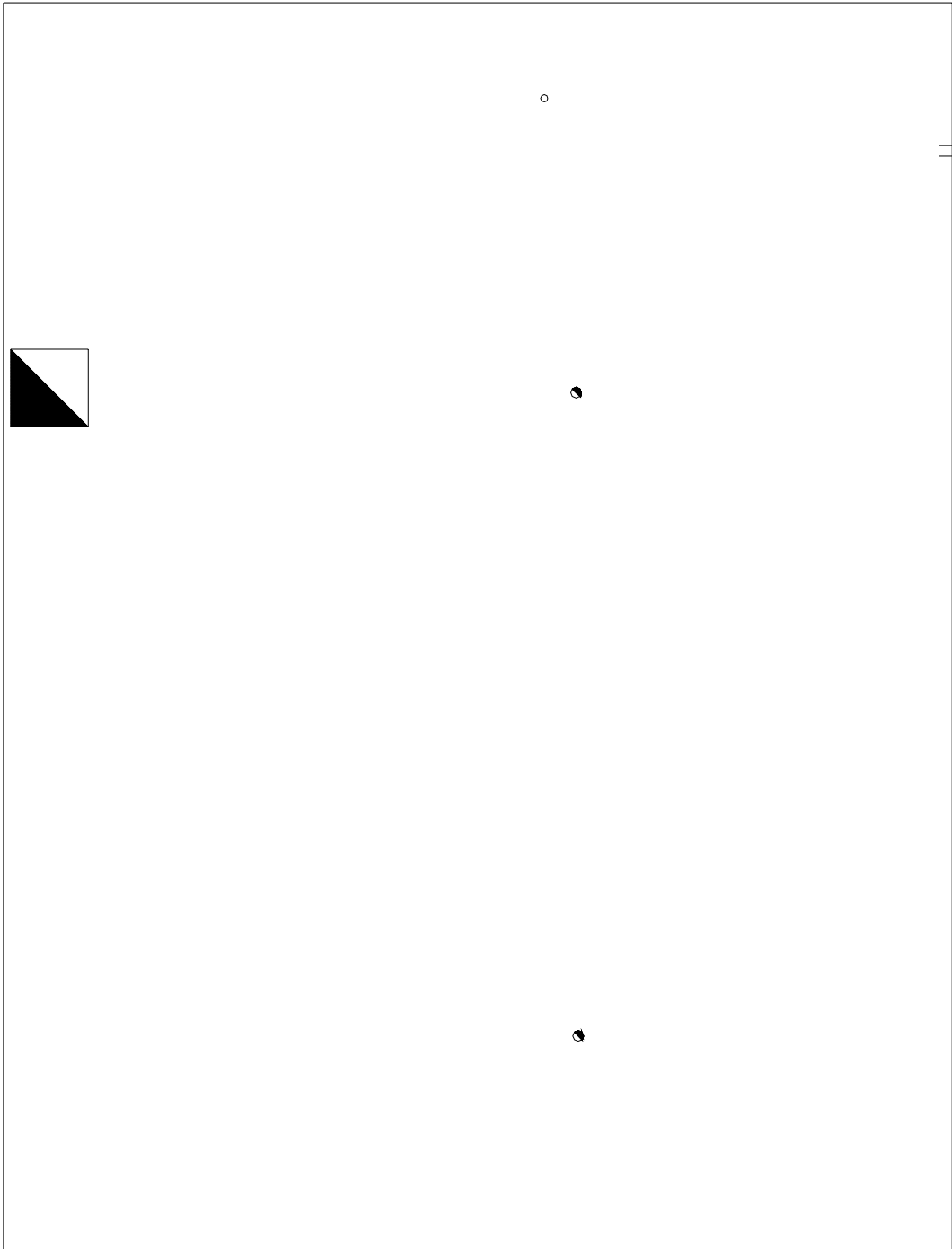

## SYMBOLS KEY

- HEAT STACK
- ▣ CHIMNEY
- DOWNSPOUT
- ⊥ SCUPPER
- ⊕ DEFECT-REPAIR
- VENT STACK

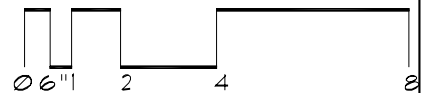

# Roof ID

Building: 32 - CT-32 - ()

Total Area: 4,872 sf

A 4,234 sf

B 638 sf

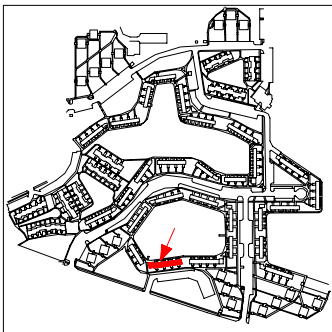
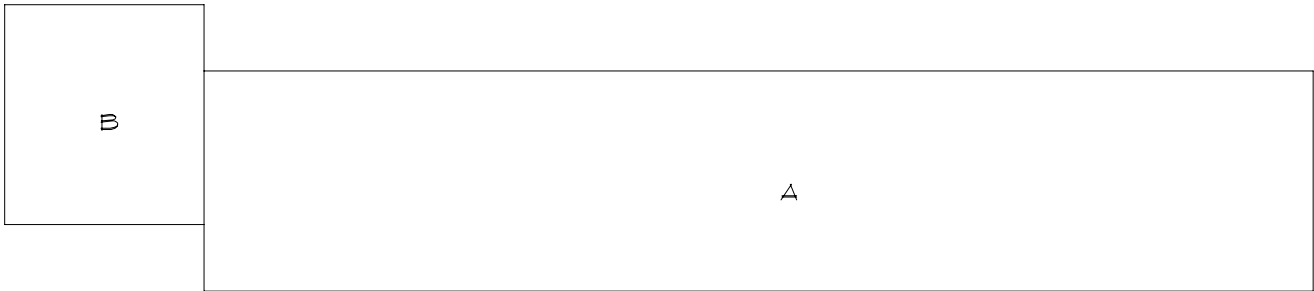

# Roof Corrective Action

## SYMBOLS KEY

- VENT STACK
- Ⓢ DEFECT-REPAIR
- STRUCTURAL SLOPE

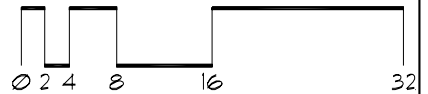
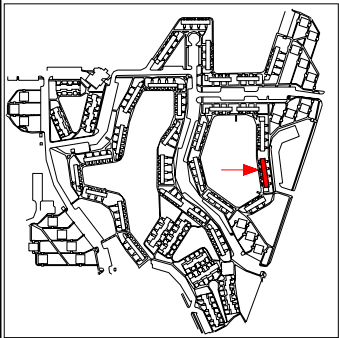
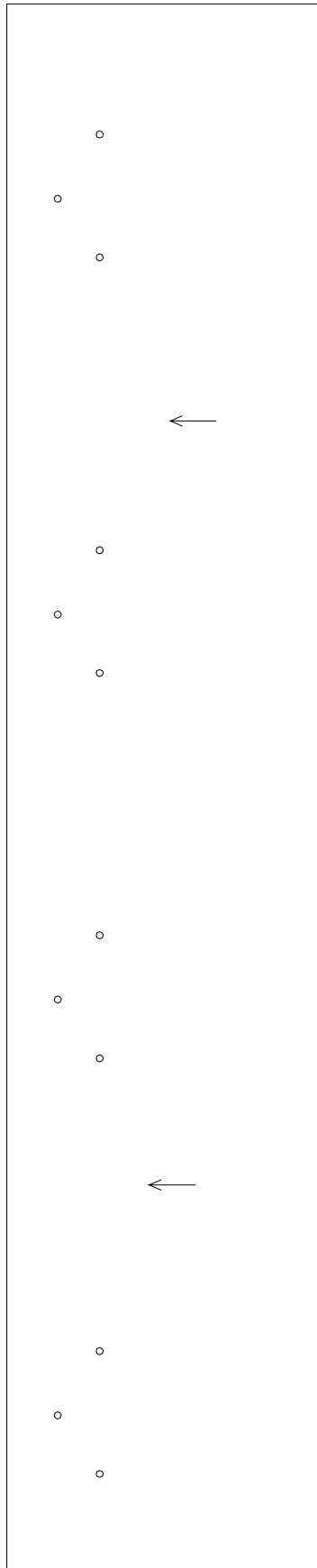

# Roof Corrective Action

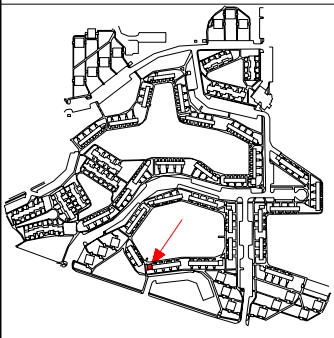
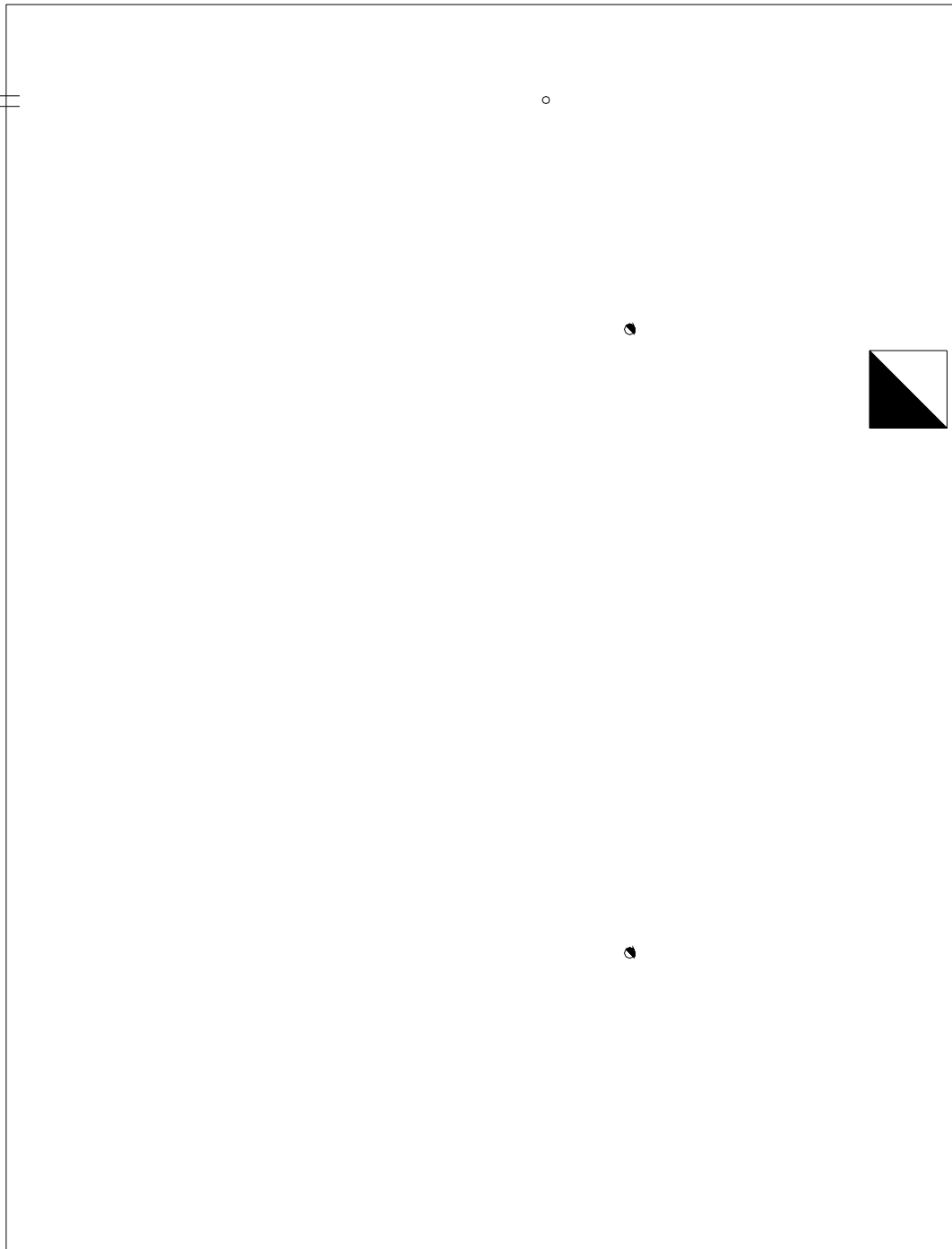

## SYMBOLS KEY

- VENT STACK
- ▀ CHIMNEY
- DOWNSPOUT
- ⊥ SCUPPER
- ⊕ HEAT STACK
- Ⓢ DEFECT-REPAIR

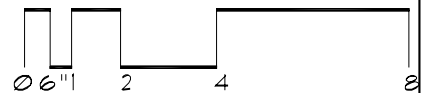

# Roof ID

Building: 33 - CT-33 - ()

Total Area: 3,190 sf

A 3,190 sf

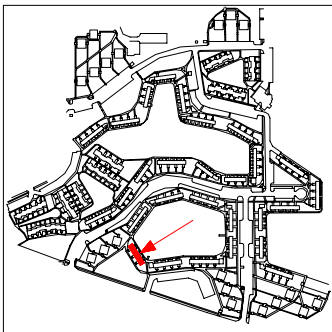
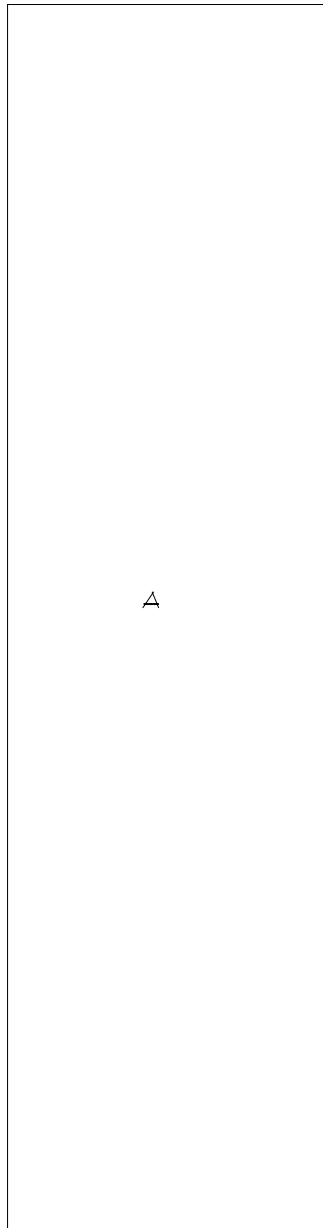



# Roof Corrective Action

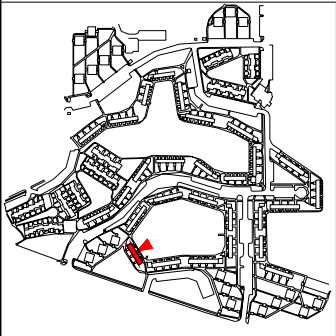
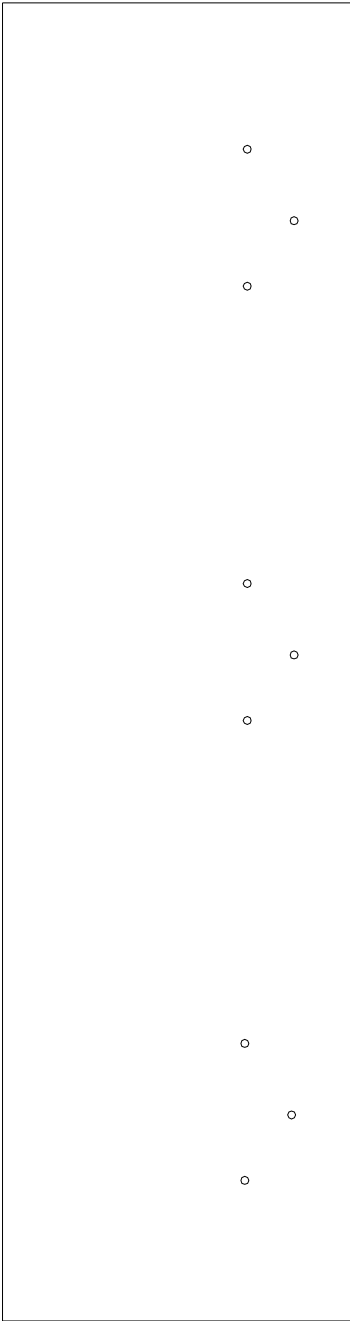

SYMBOLS KEY  
○ VENT STACK

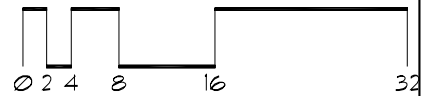

# Roof ID

Building: 34 - CT-34 - ()

Total Area: 4,234 sf

A 4,234 sf

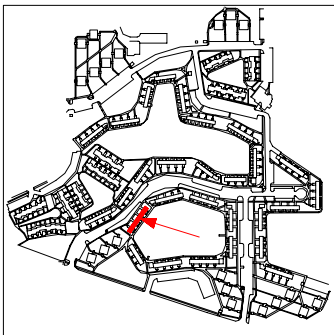
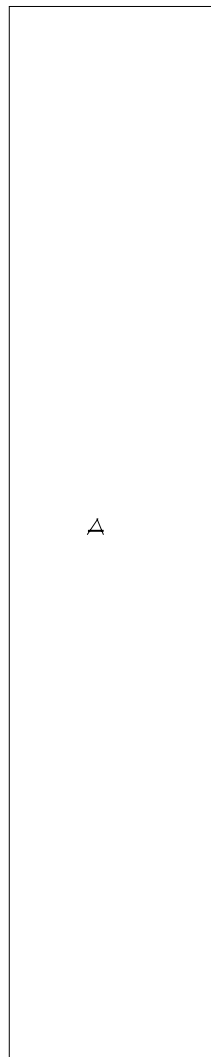

# Roof Corrective Action

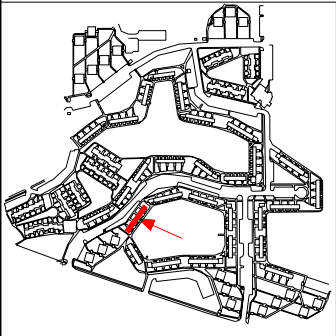
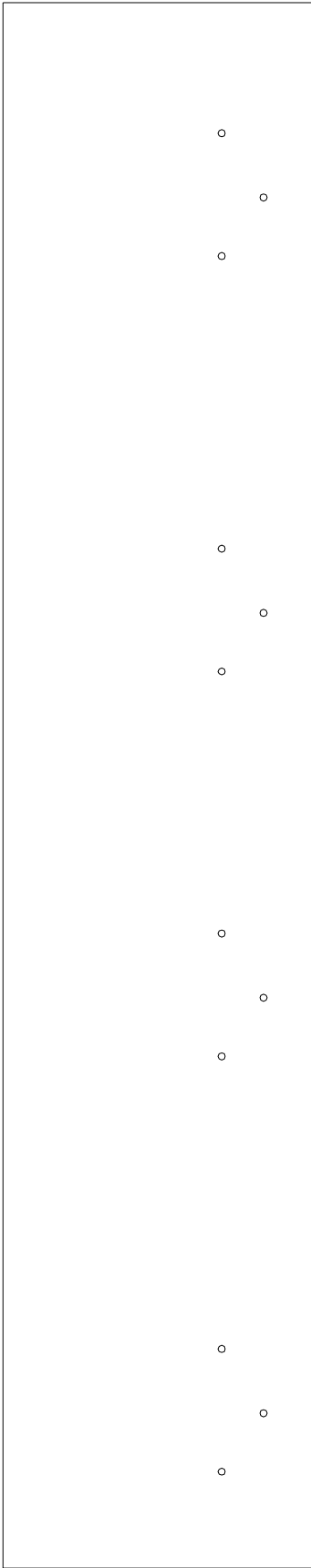

SYMBOLS KEY  
| ○ VENT STACK

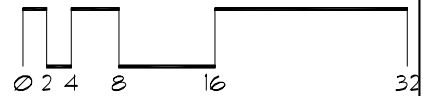

# Roof ID

Building: 35 - CT-35 - ()

Total Area: 3,701 sf

A 3,190 sf

B 511 sf

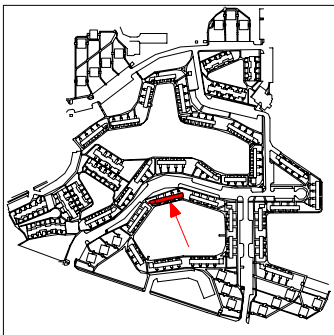

# Roof Corrective Action

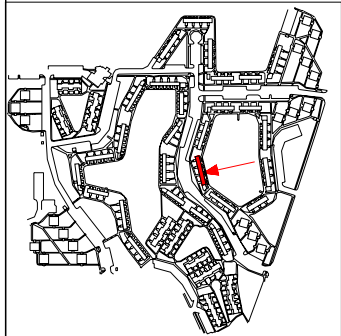
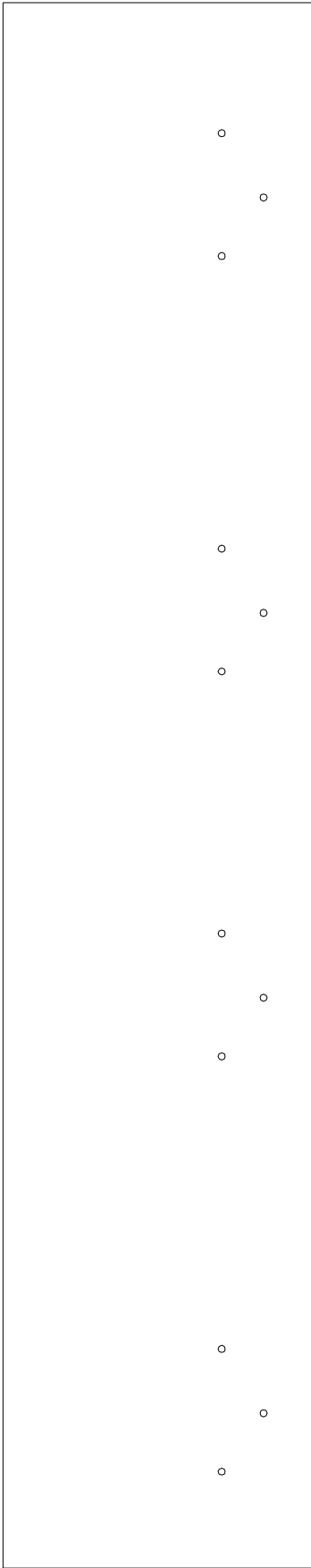

SYMBOLS KEY  
○ VENT STACK

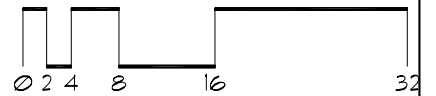
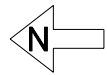

# Roof Corrective Action

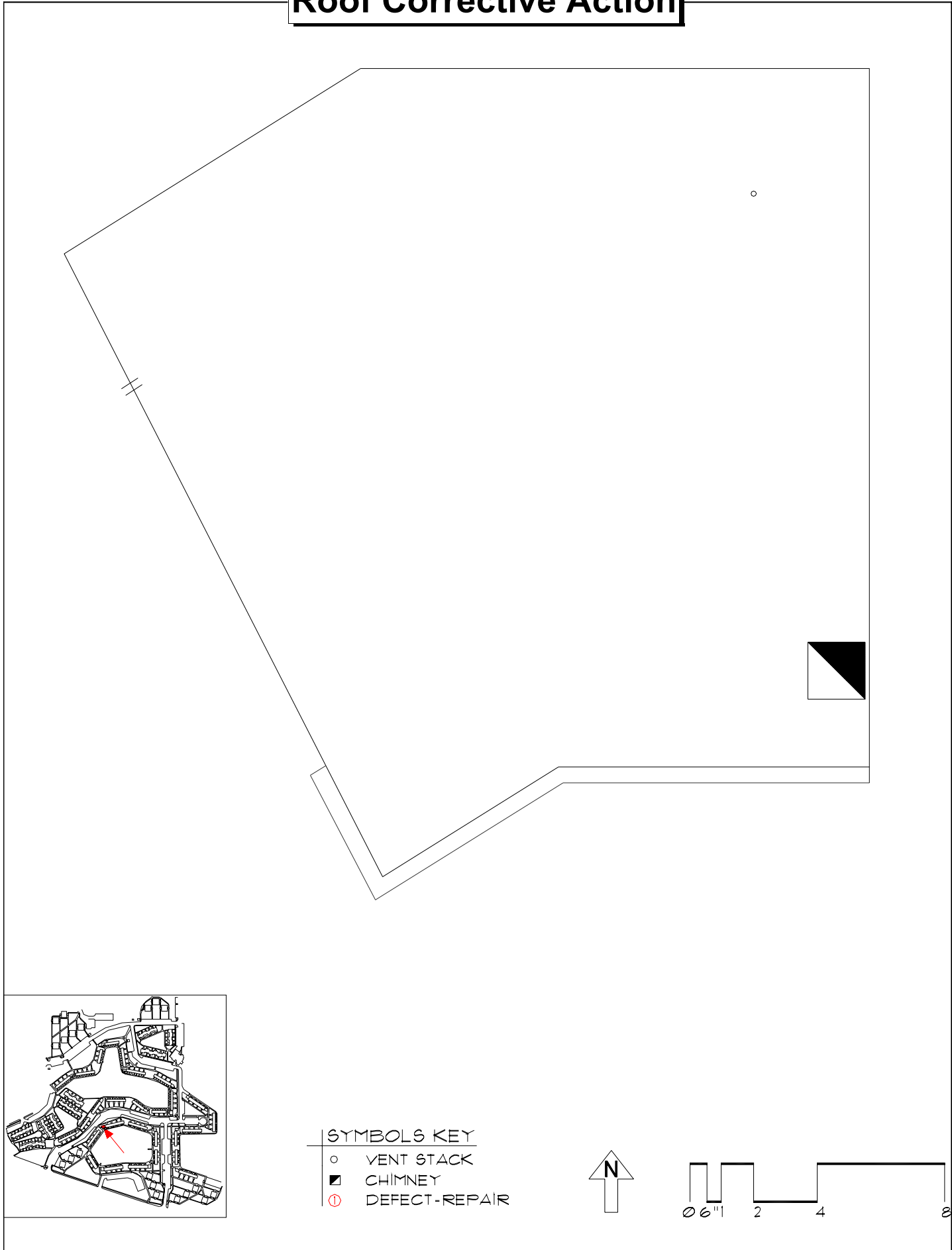

- SYMBOLS KEY**
- VENT STACK
  - ◼ CHIMNEY
  - Ⓢ DEFECT-REPAIR

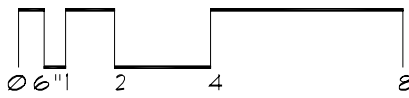

# Roof ID

Building: 36 - CT-36 - ()

Total Area: 4,234 sf

A 4,234 sf

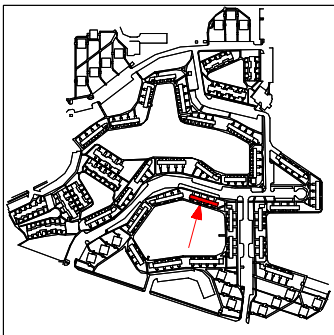
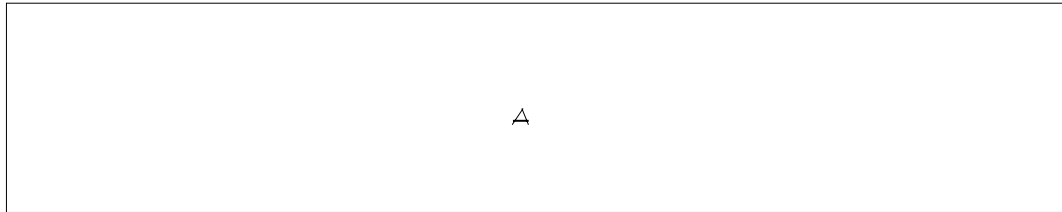

# Roof Corrective Action

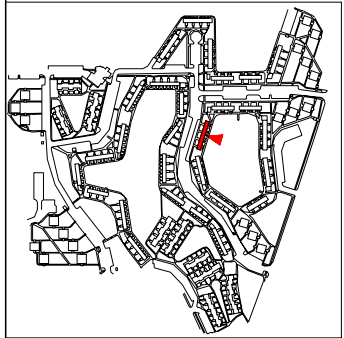
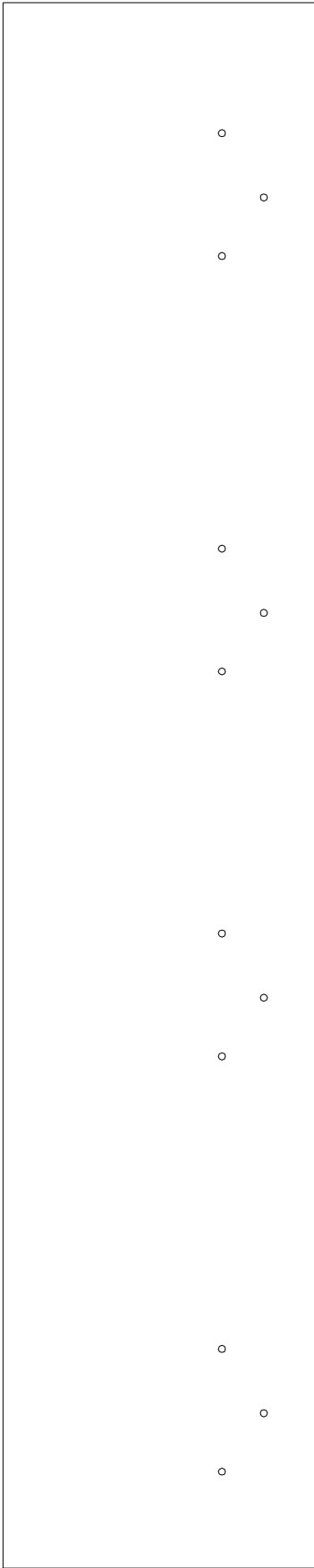

SYMBOLS KEY

○ VENT STACK





# Roof ID

Building: 37 - CT-37 - ()

Total Area: 3,828 sf

A 3,190 sf

B 638 sf

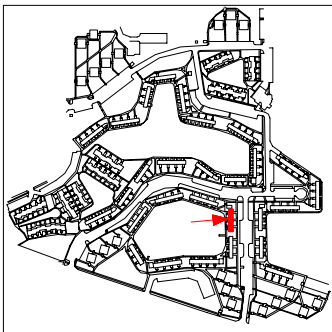
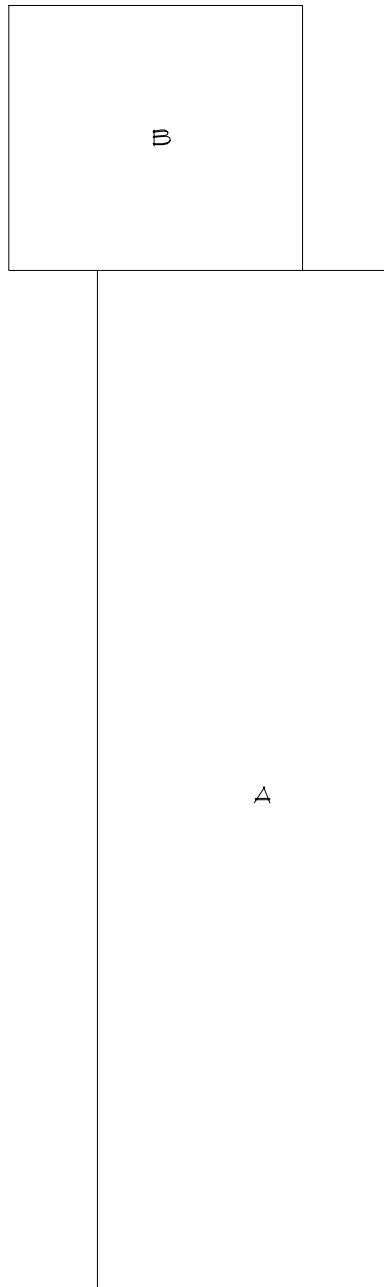

# Roof Corrective Action

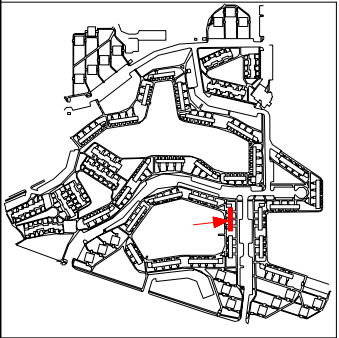
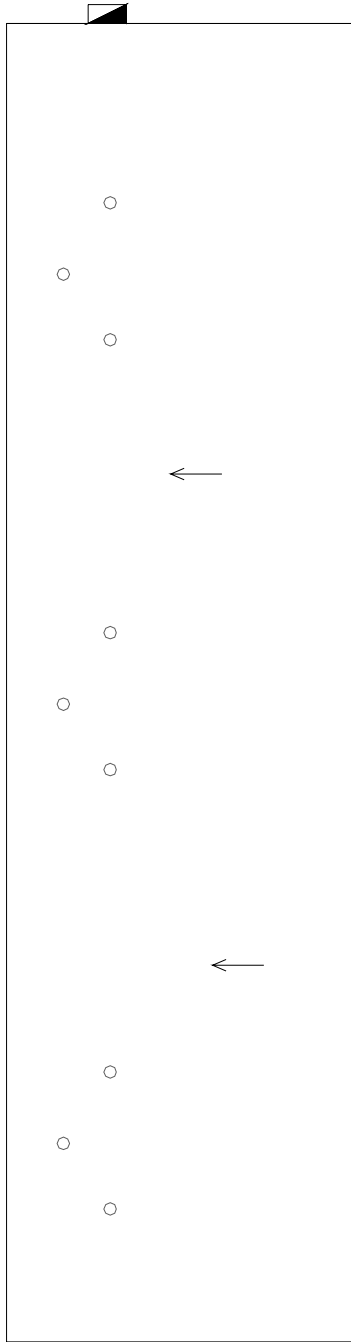

**SYMBOLS KEY**  
○ VENT STACK  
→ STRUCTURAL SLOPE  
Ⓢ DEFECT-REPAIR

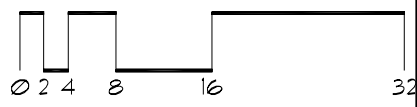

# Roof Corrective Action

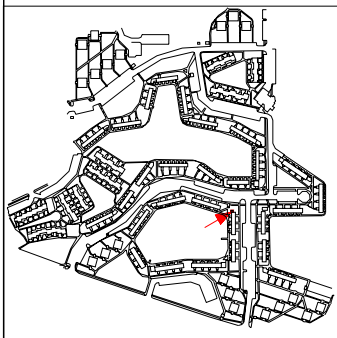
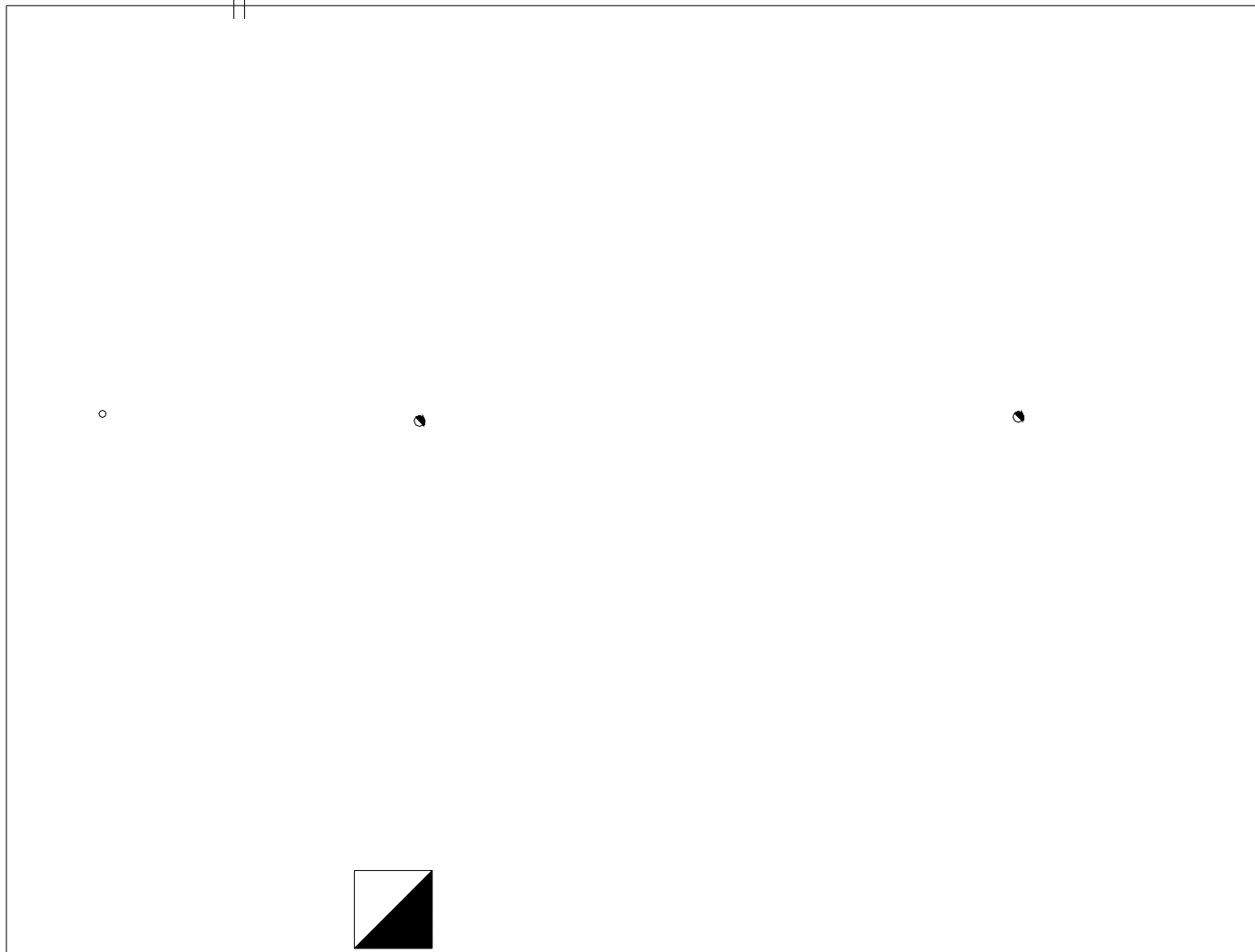

## SYMBOLS KEY

- VENT STACK
- ▣ CHIMNEY
- Ⓢ DEFECT-REPAIR
- DOWNSPOUT
- ⊥ SCUPPER
- HEAT STACK

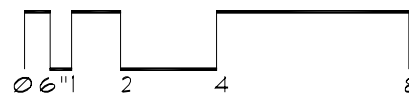

# Roof ID

Building: 38 - CT-38 - ()

Total Area: 3,190 sf

A 3,190 sf

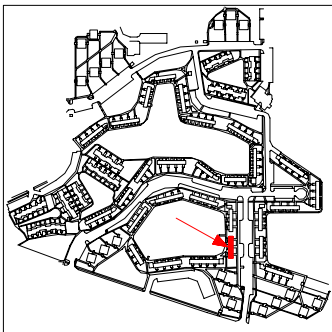
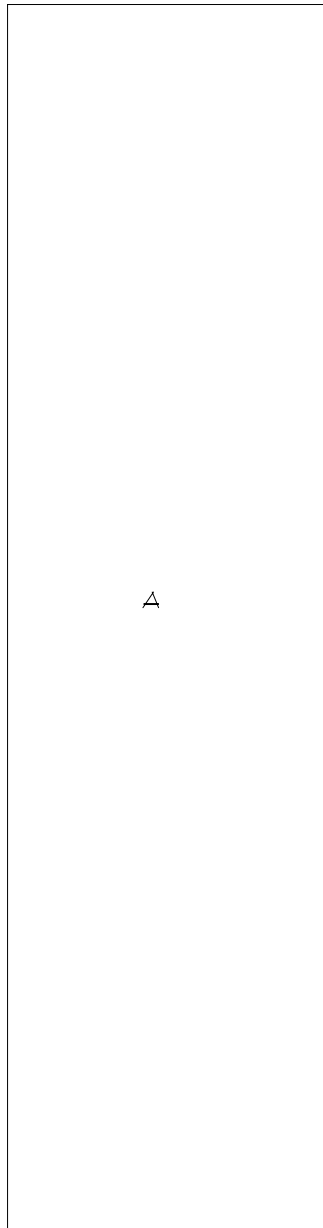

# Roof Corrective Action

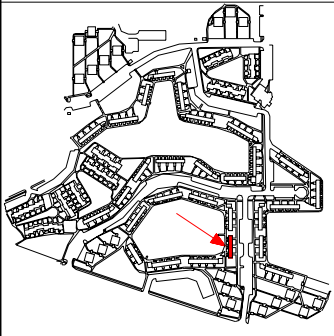
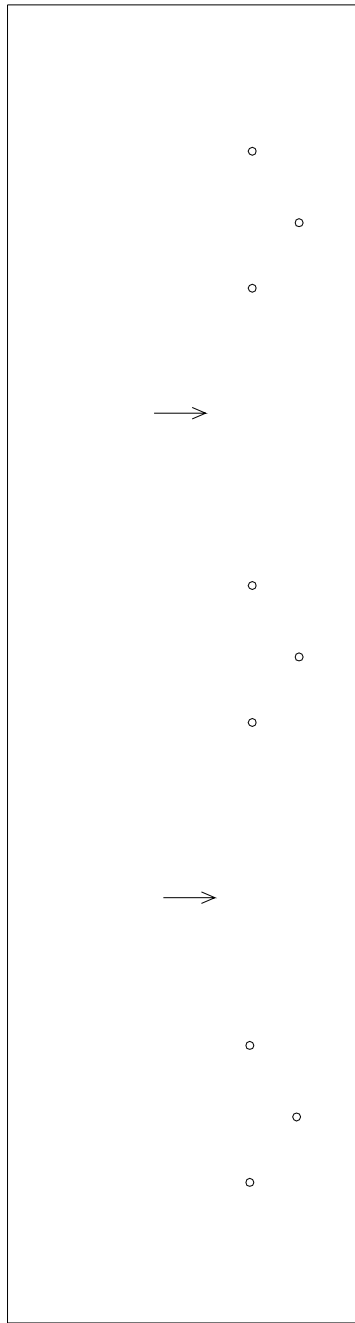

## SYMBOLS KEY

- VENT STACK
- STRUCTURAL SLOPE
- ① DEFECT-REPAIR

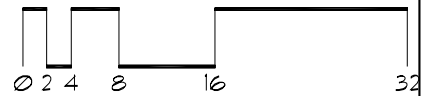

# Roof ID

Building: 39 - CT-39 - ()

Total Area: 5,165 sf

A 4,234 sf

B 511 sf

C 420 sf

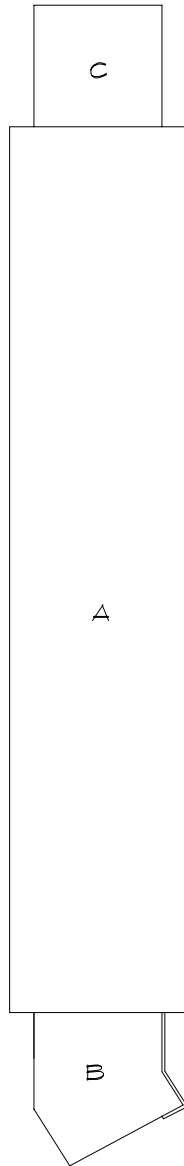
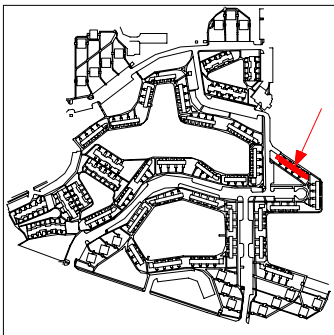

# Roof Corrective Action

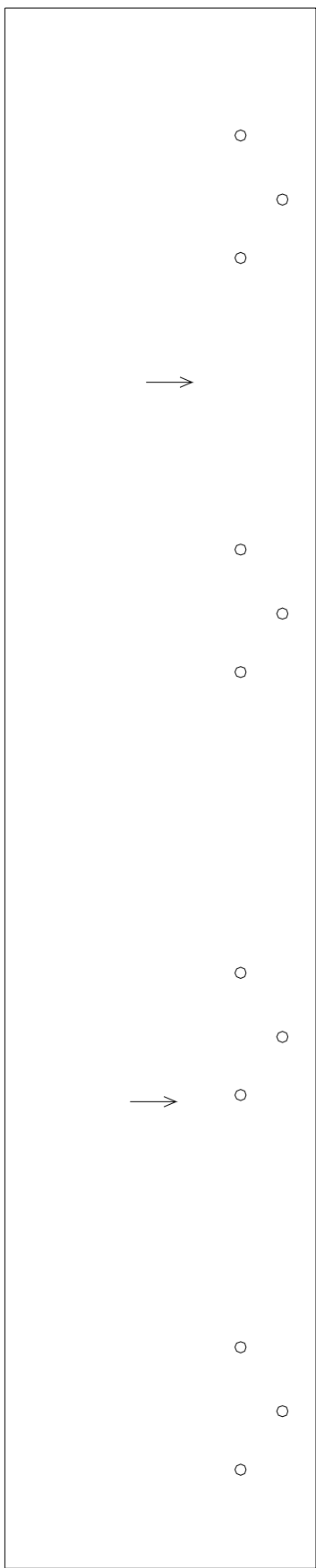

## SYMBOLS KEY

- VENT STACK
- Ⓢ DEFECT-REPAIR
- STRUCTURAL SLOPE

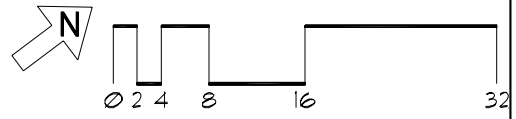
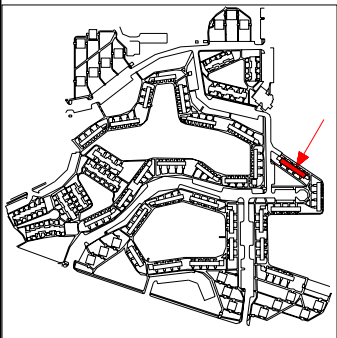

# Roof Corrective Action

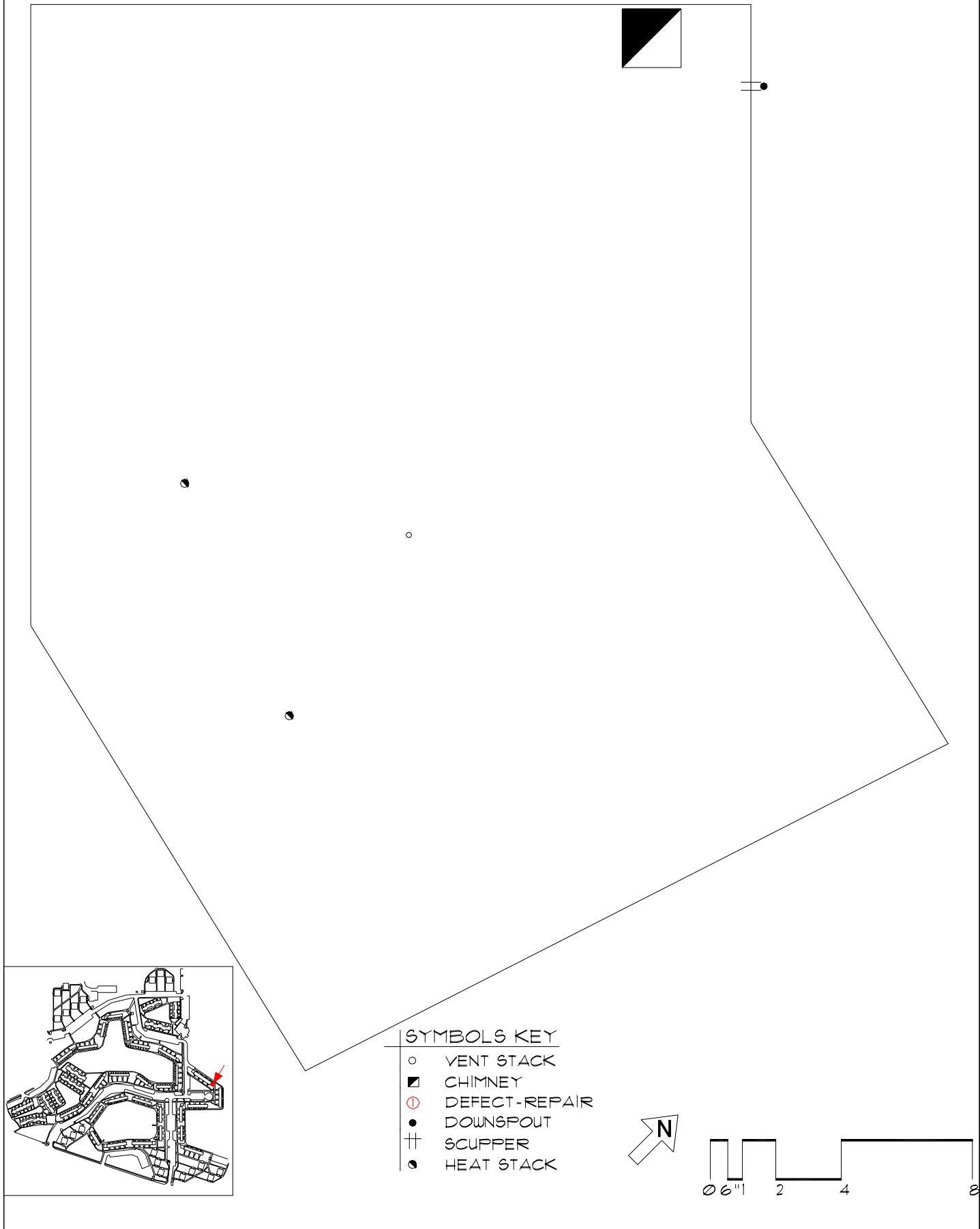

### SYMBOLS KEY

- VENT STACK
- ▣ CHIMNEY
- ⊖ DEFECT-REPAIR
- DOWNSPOUT
- ⊕ SCUPPER
- HEAT STACK





# Roof Corrective Action

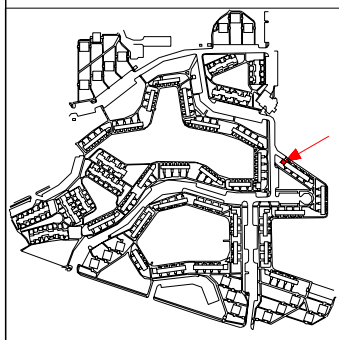
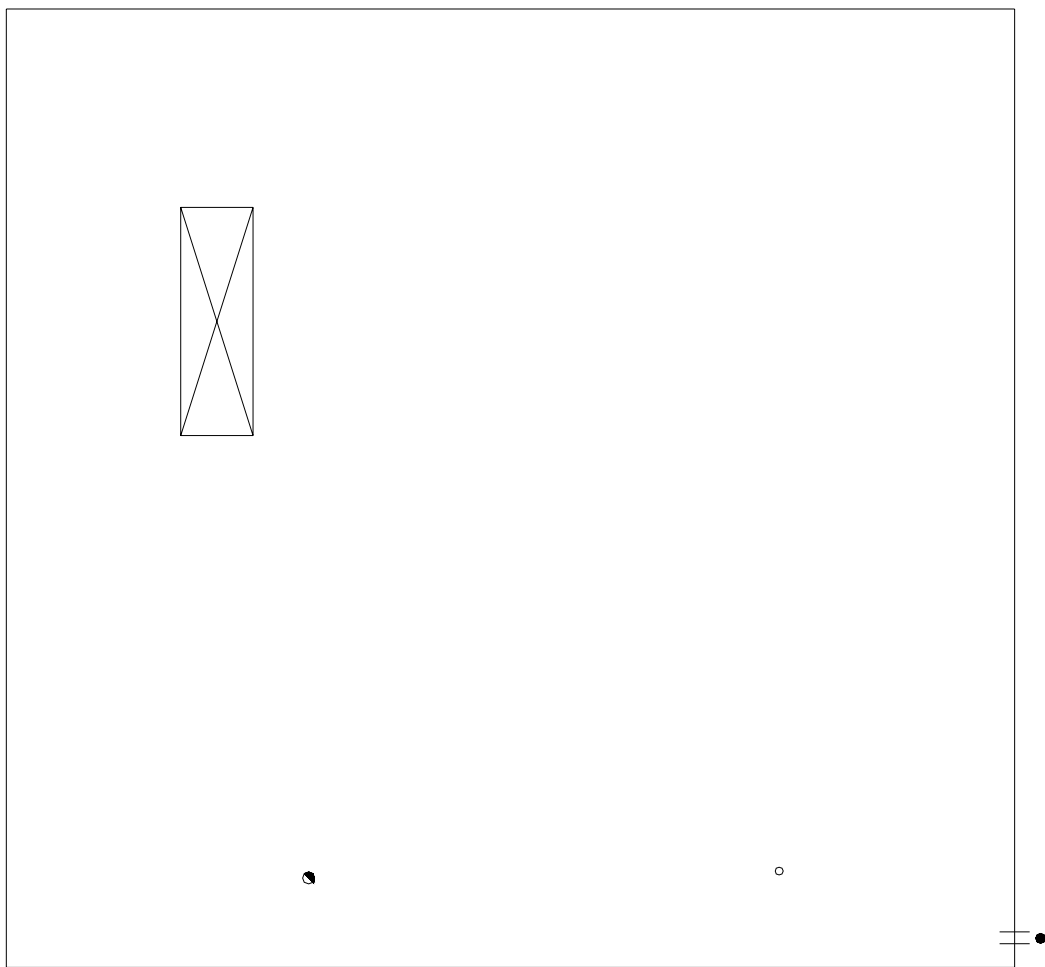

## SYMBOLS KEY

- VENT STACK
- ⊠ SKYLIGHT
- DOWNSPOUT
- † SCUPPER
- HEAT STACK
- ① DEFECT-REPAIR

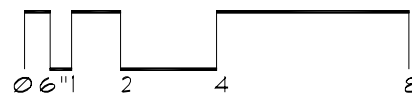

# Roof ID

Building: 40 - CT-40 - ()

Total Area: 4,234 sf

A 4,234 sf

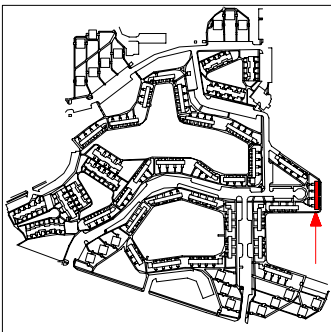
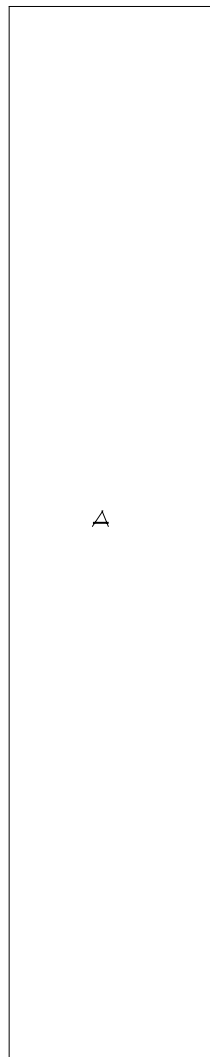

# Roof Corrective Action

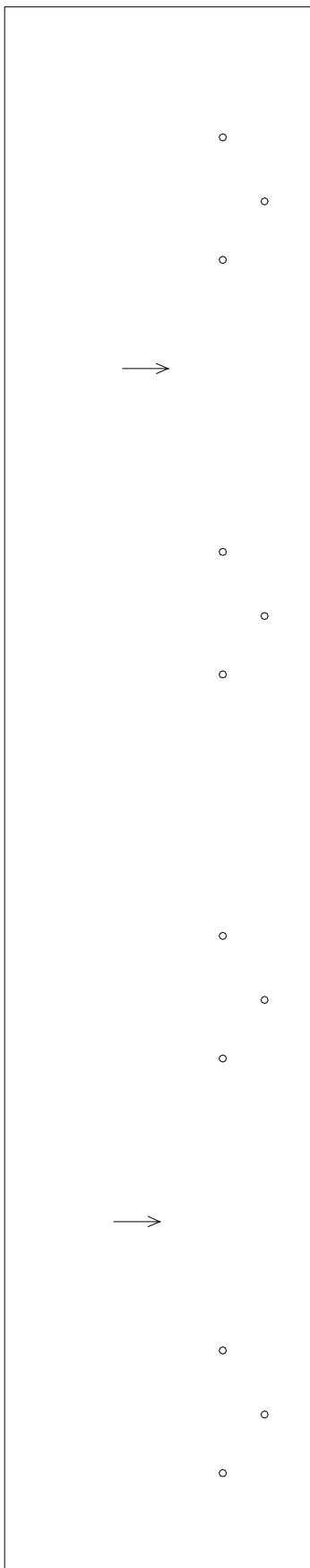

## SYMBOLS KEY

- VENT STACK
- STRUCTURAL SLOPE
- Ⓢ DEFECT-REPAIR

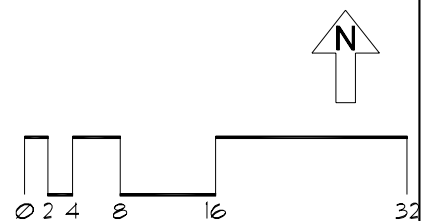
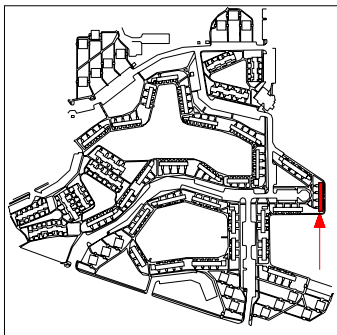

# Roof ID

Building: 41 - CT-41 - ()

Total Area: 4,234 sf

A 4,234 sf

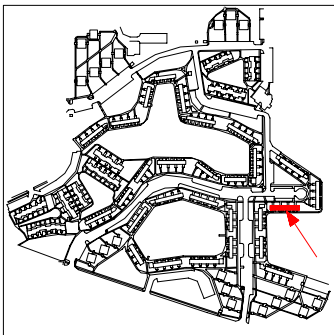
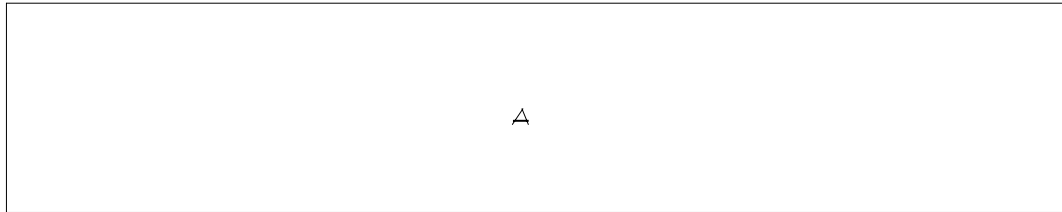

# Roof Corrective Action

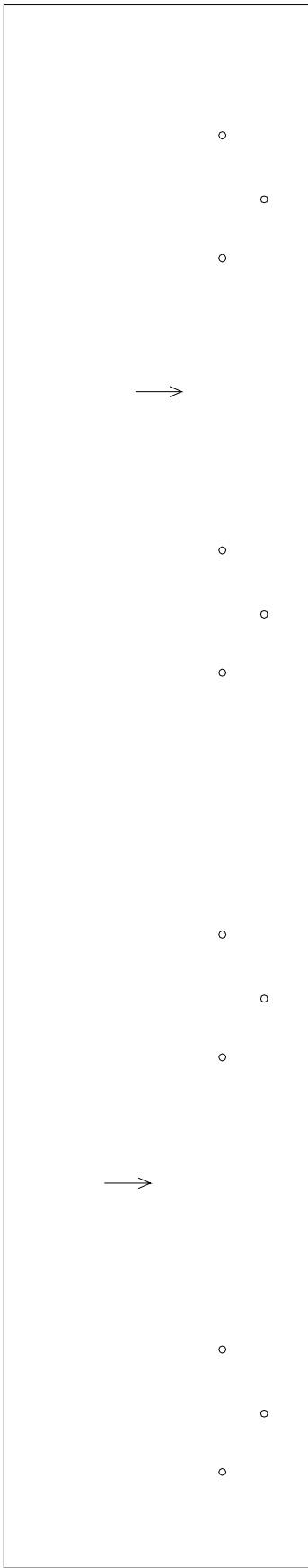

## SYMBOLS KEY

- VENT STACK
- STRUCTURAL SLOPE
- Ⓜ DEFECT-REPAIR

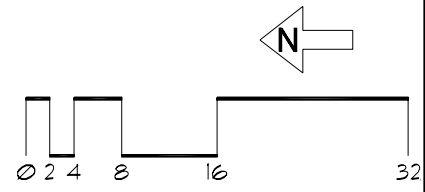
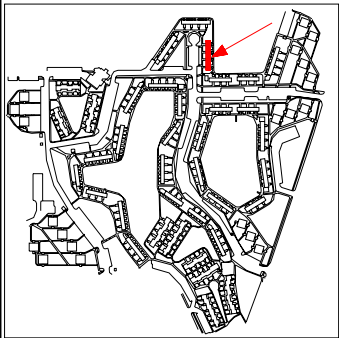

# Roof ID

Building: 42 - CT-42 - ()

Total Area: 3,799 sf

A 3,190 sf

B 609 sf

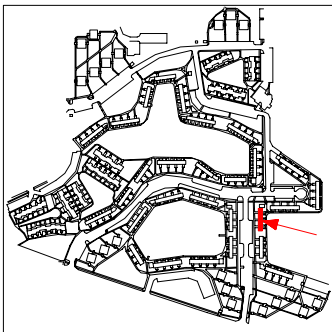
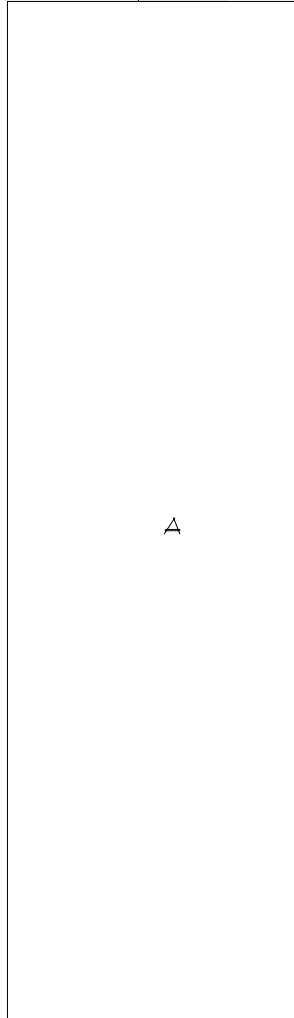
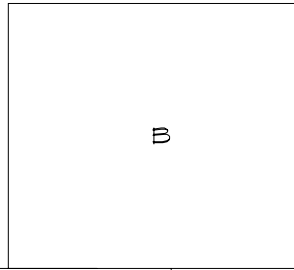

# Roof Corrective Action

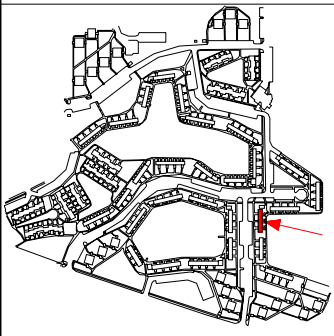
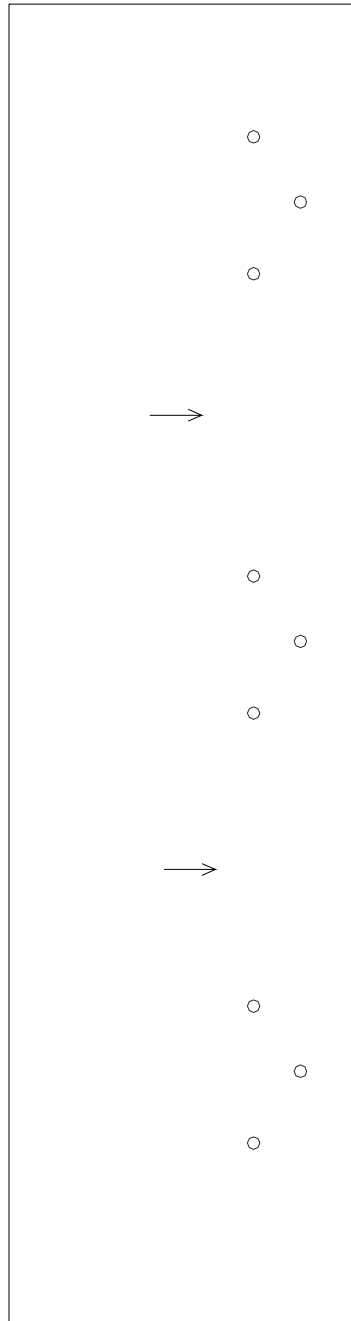

## SYMBOLS KEY

- VENT STACK
- ⊖ DEFECT-REPAIR
- STRUCTURAL SLOPE

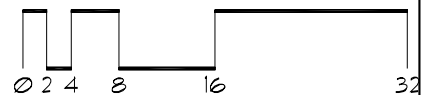

# Roof Corrective Action

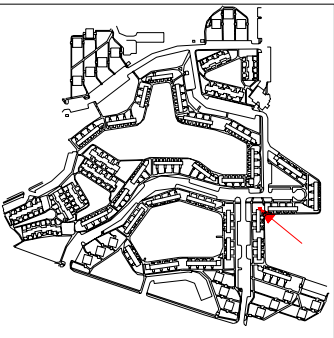
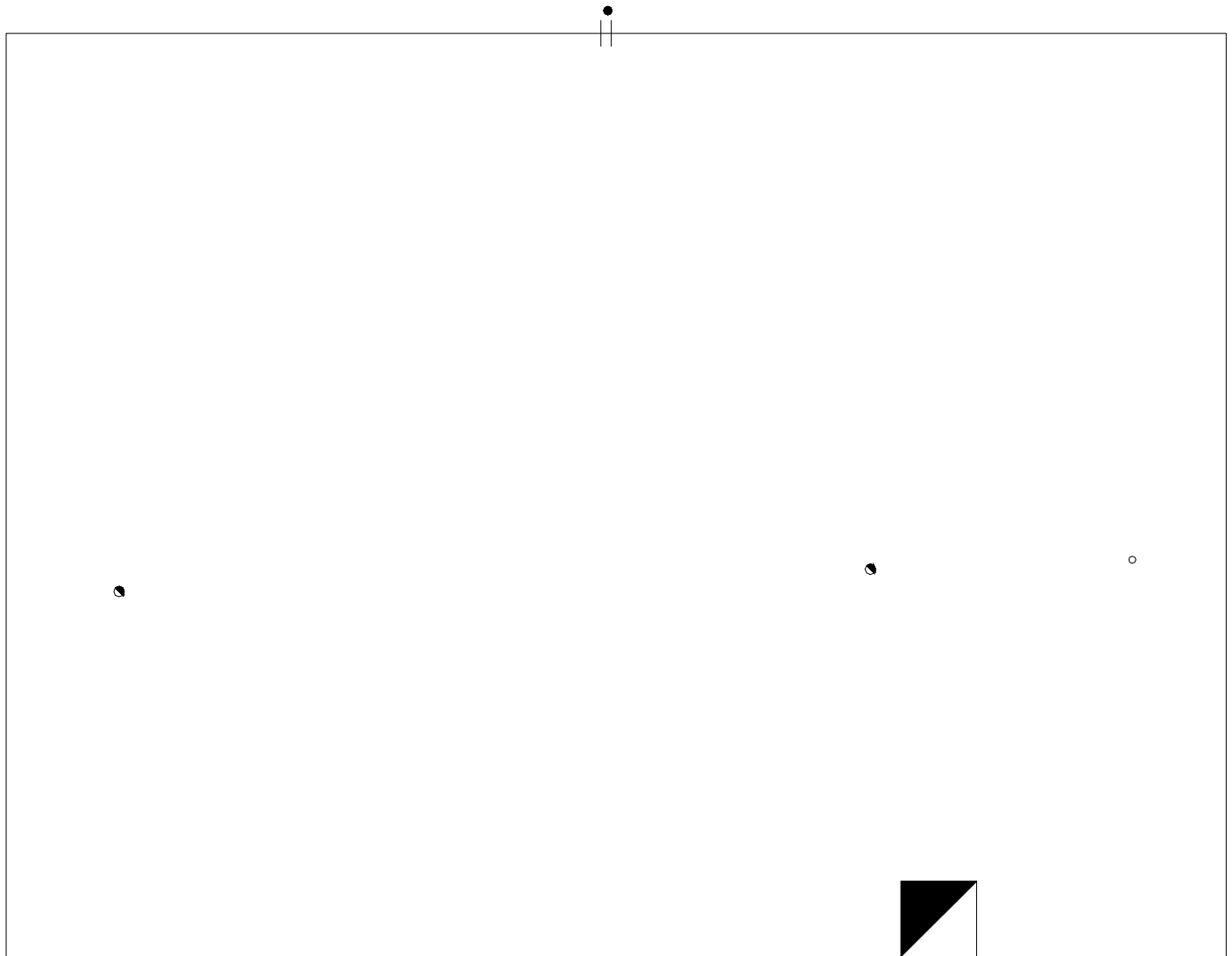

## SYMBOLS KEY

- CHIMNEY
- VENT STACK
- DOWNSPOUT
- † SCUPPER
- HEAT STACK
- STRUCTURAL SLOPE
- Ⓢ DEFECT-REPAIR

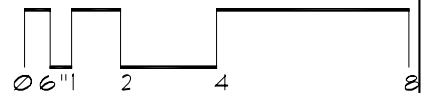



# Roof ID

Building: 43 - CT-43 - ()

Total Area: 2,650 sf

A 2,650 sf

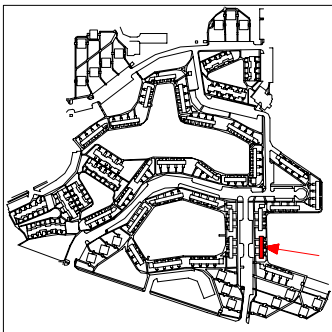
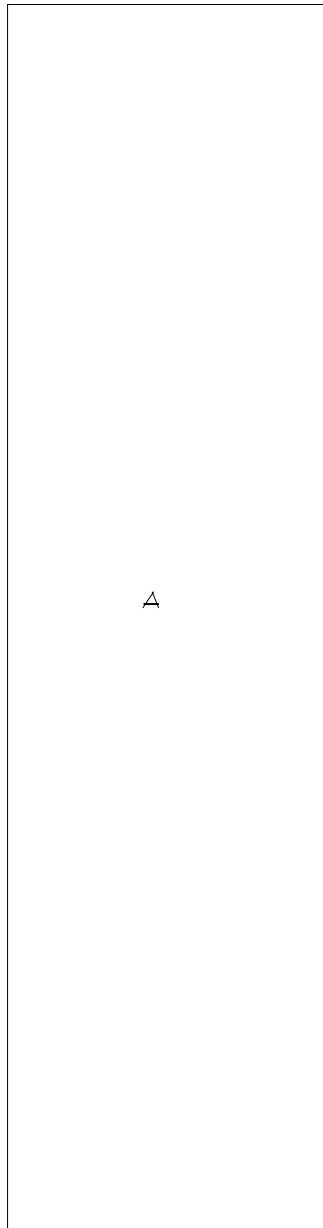

# Roof Corrective Action

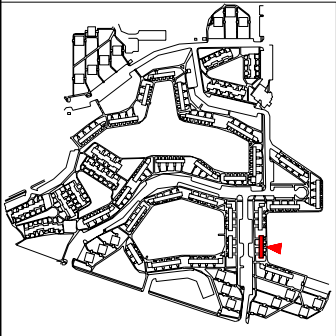
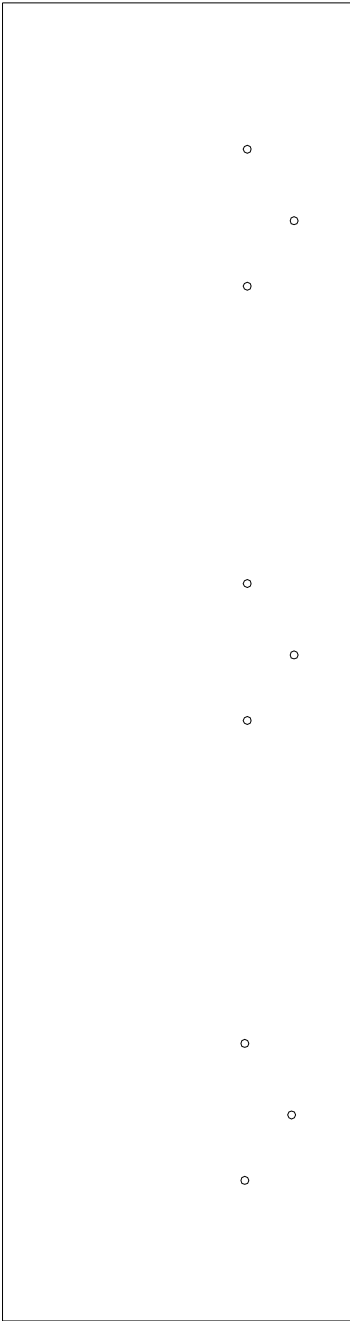

SYMBOLS KEY  
○ VENT STACK

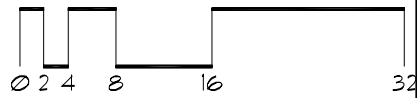
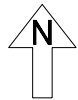

# Roof ID

Building: 44 - CT-44 - ()

Total Area: 4,806 sf

A 4,234 sf

B 572 sf

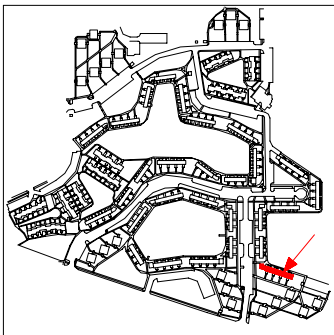

# Roof Corrective Action

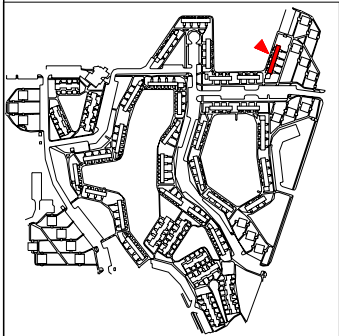
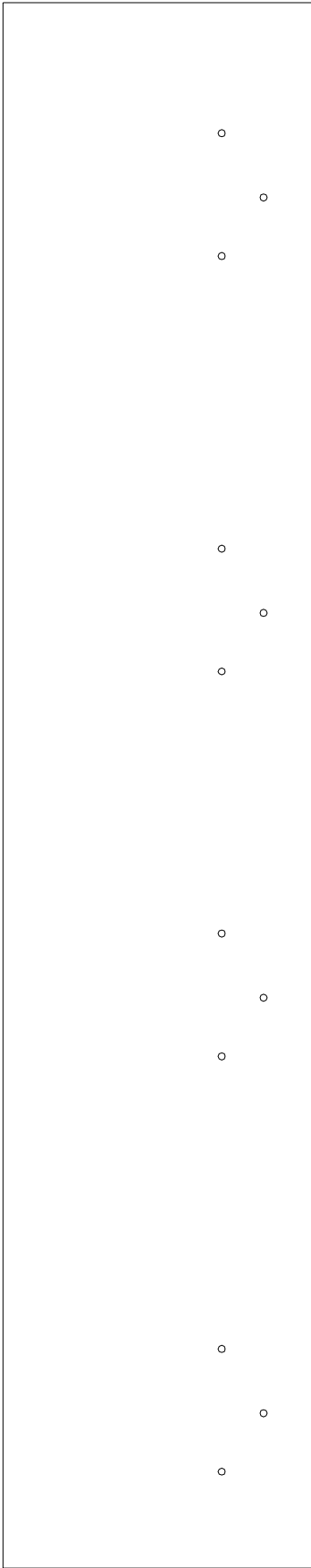

SYMBOLS KEY  
○ VENT STACK

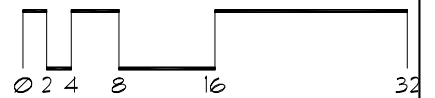
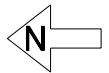

# Roof Corrective Action

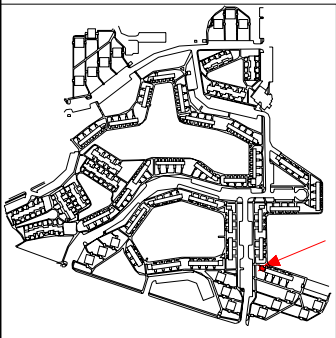
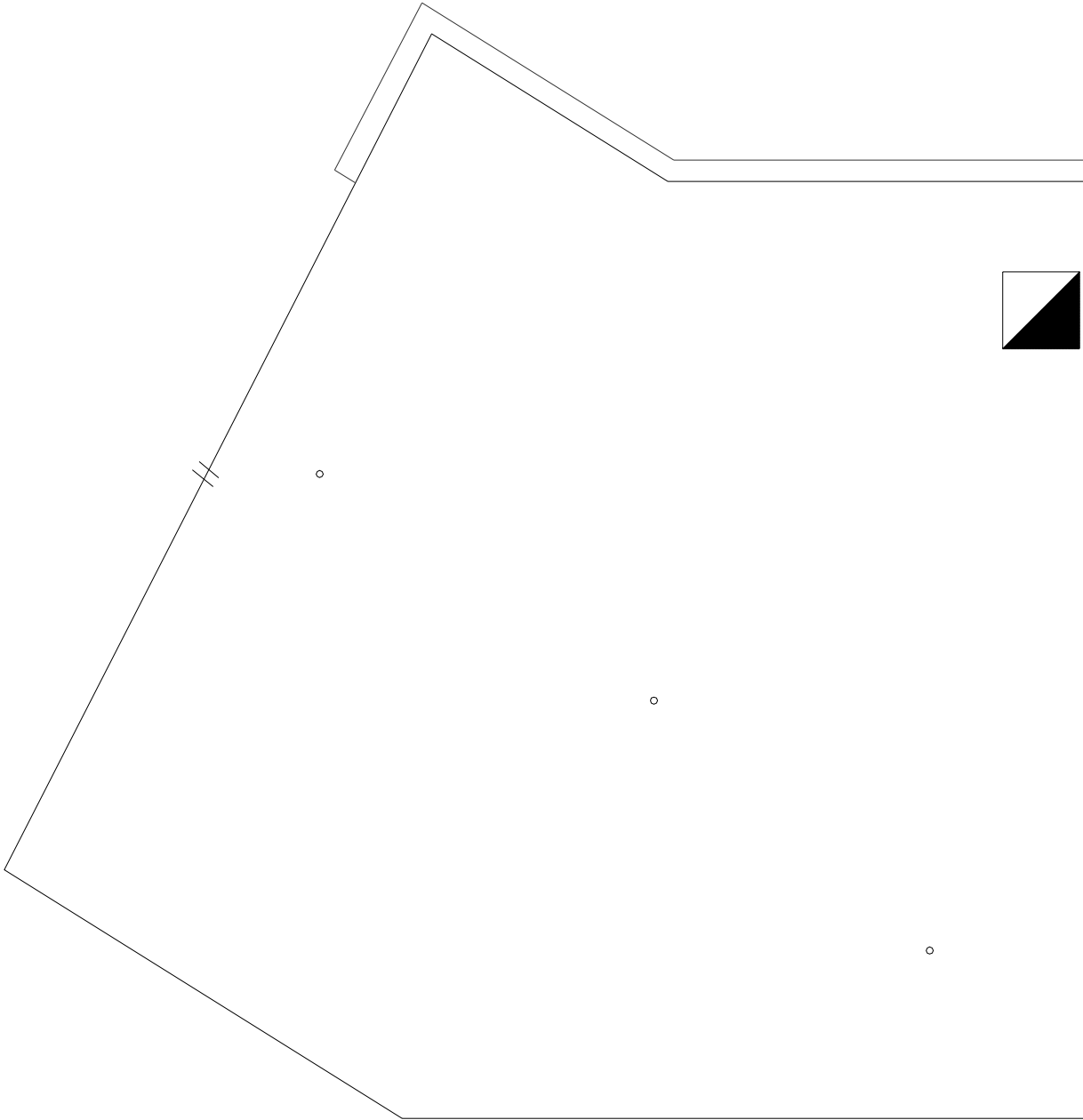

- SYMBOLS KEY**
- VENT STACK
  - CHIMNEY
  - ⊕ DEFECT-NO REPAIR
  - ⊕ SCUPPER

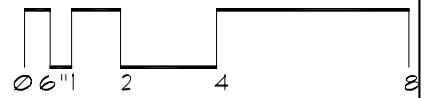

# Roof ID

Building: 45 - CT-45 - ()

Total Area: 2,650 sf

A 2,650 sf

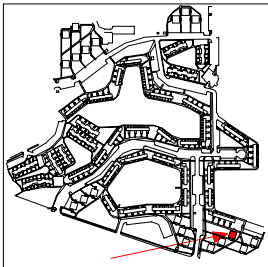
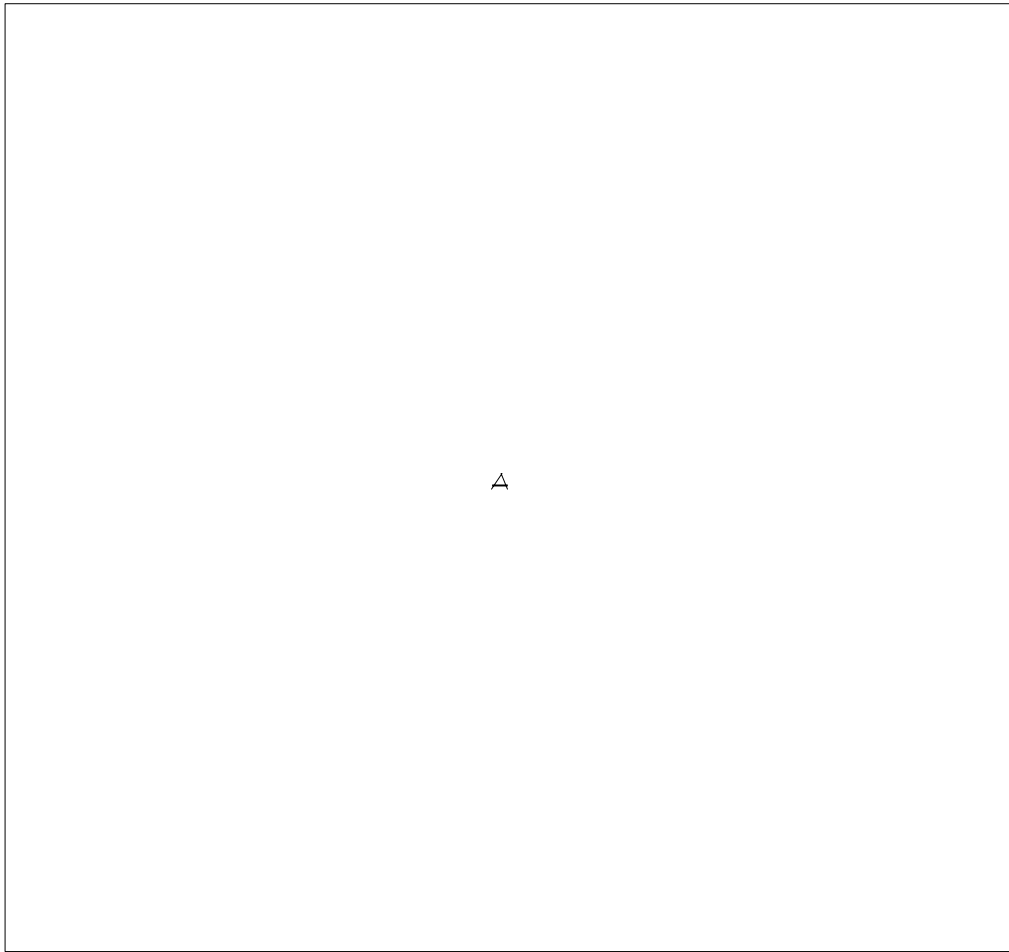

# Roof Corrective Action

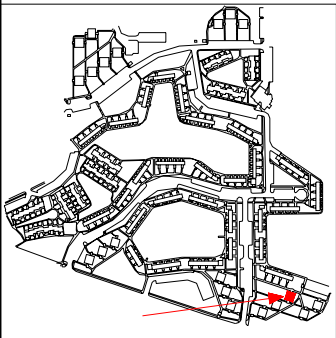
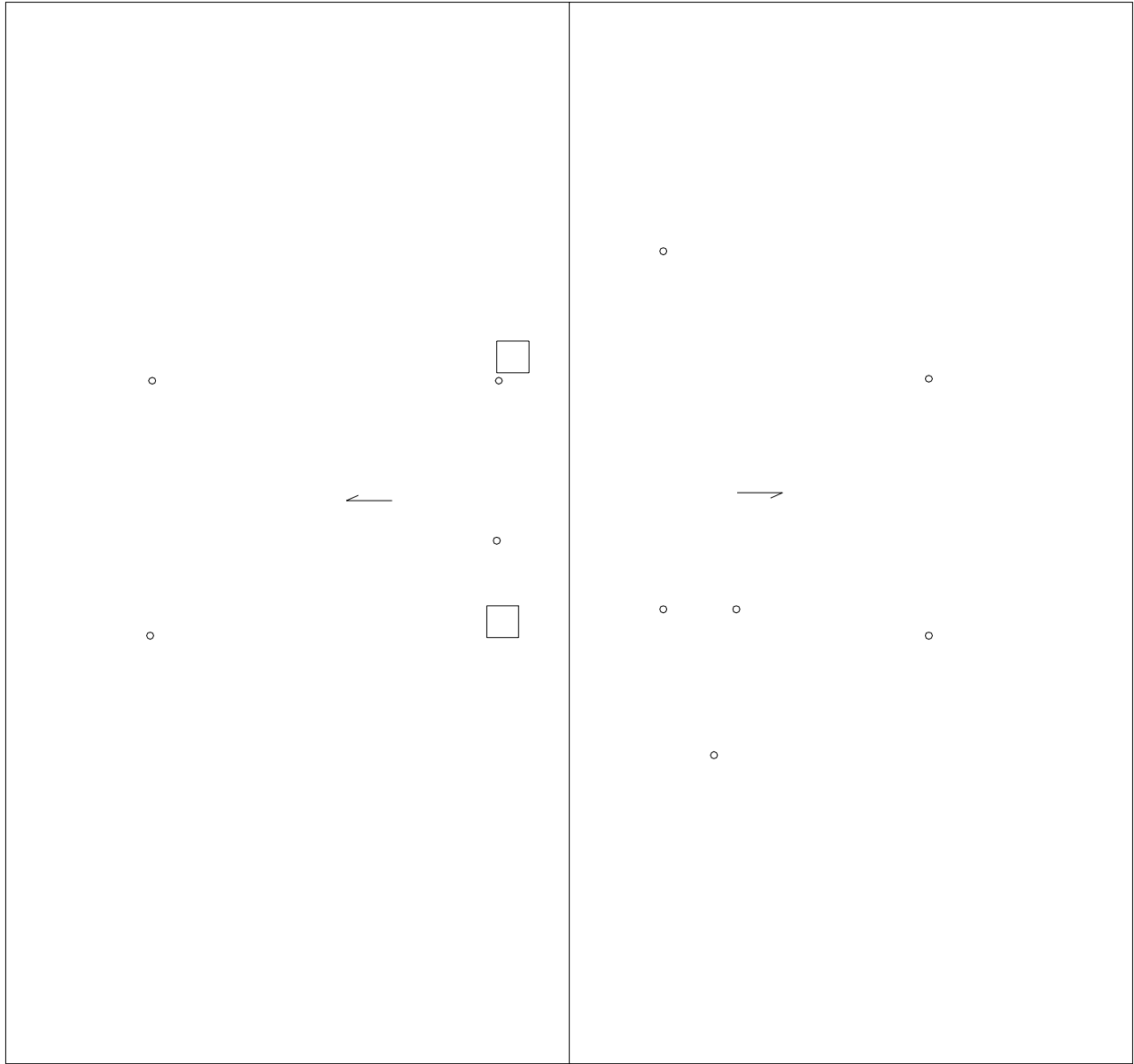

## SYMBOLS KEY

- ROOF CURB
- VENT STACK
- SLOPE DIRECTION
- Ⓢ DEFECT-REPAIR

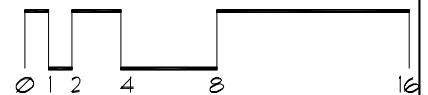

# Roof ID

Building: 46 - CT-46 - ()

Total Area: 2,650 sf

A 2,650 sf

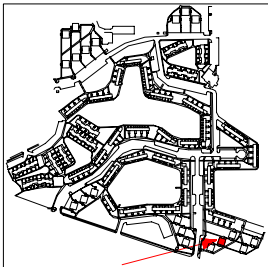
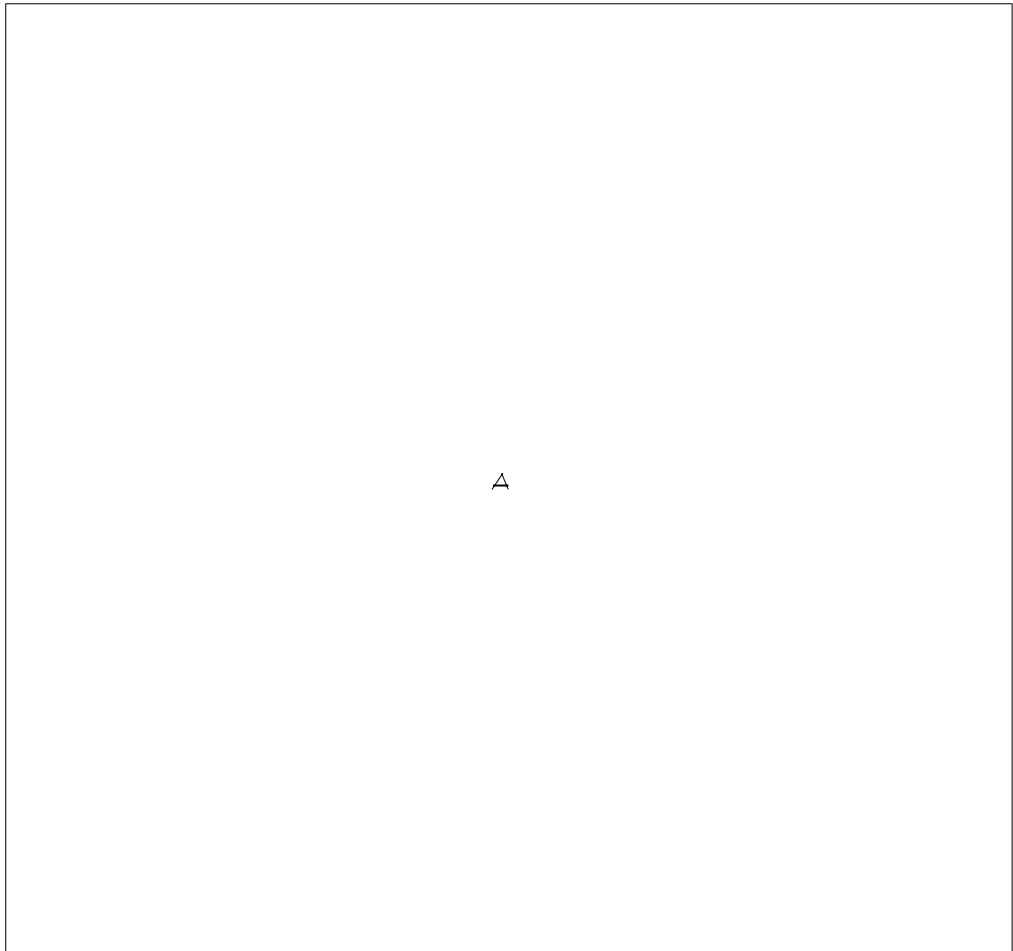



# Roof Corrective Action

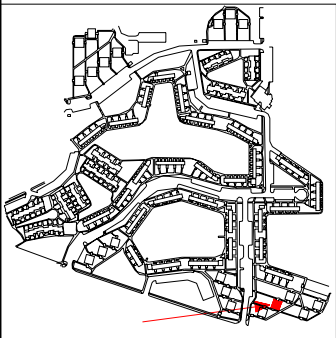
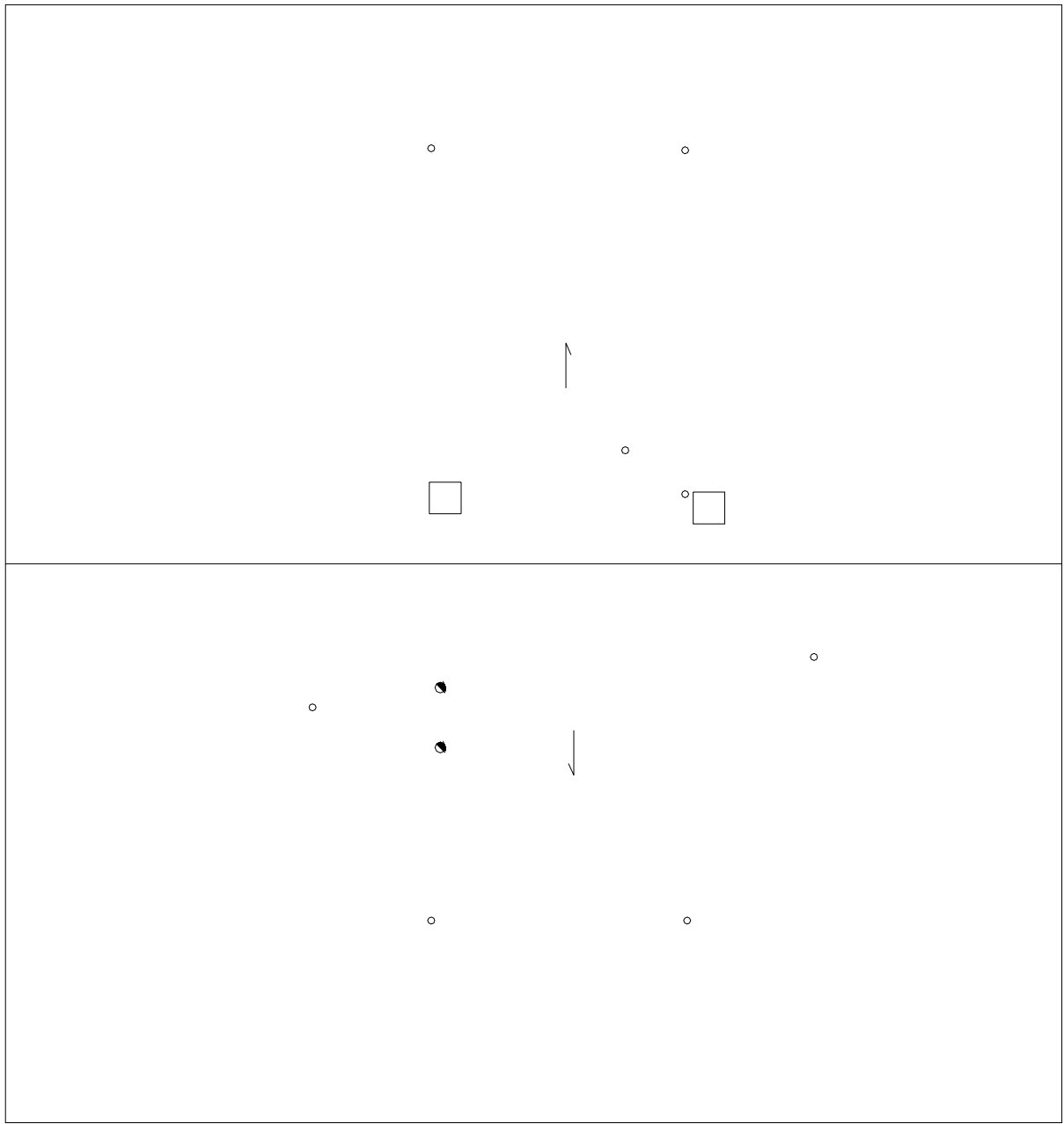

### SYMBOLS KEY

- ROOF CURB
- VENT STACK
- ↗ SLOPE DIRECTION
- DEFECT-REPAIR
- HEAT STACK

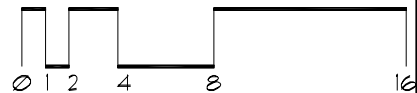

# Roof ID

Building: 47 - CT-47 - ()

Total Area: 2,650 sf

A 2,650 sf

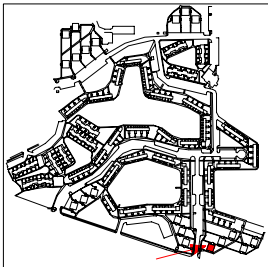
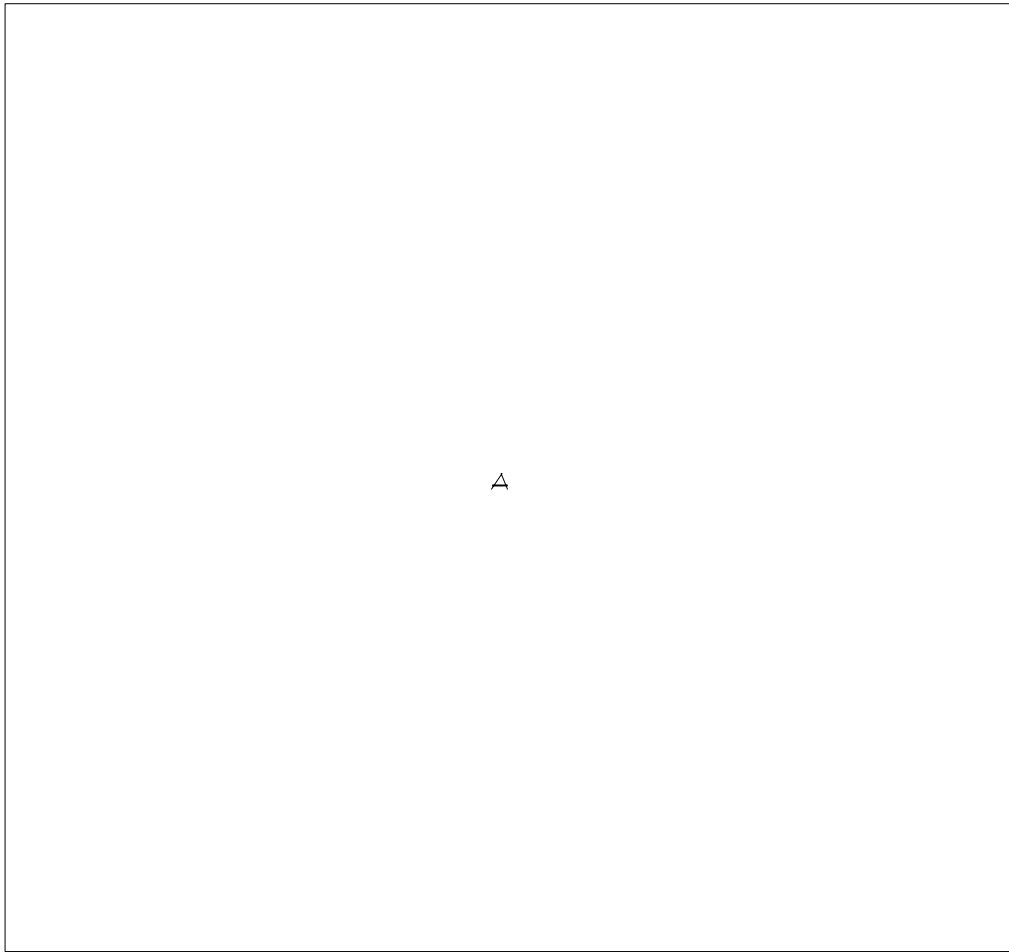

# Roof Corrective Action

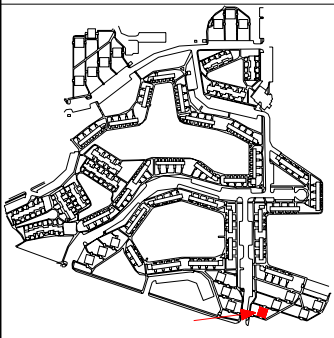
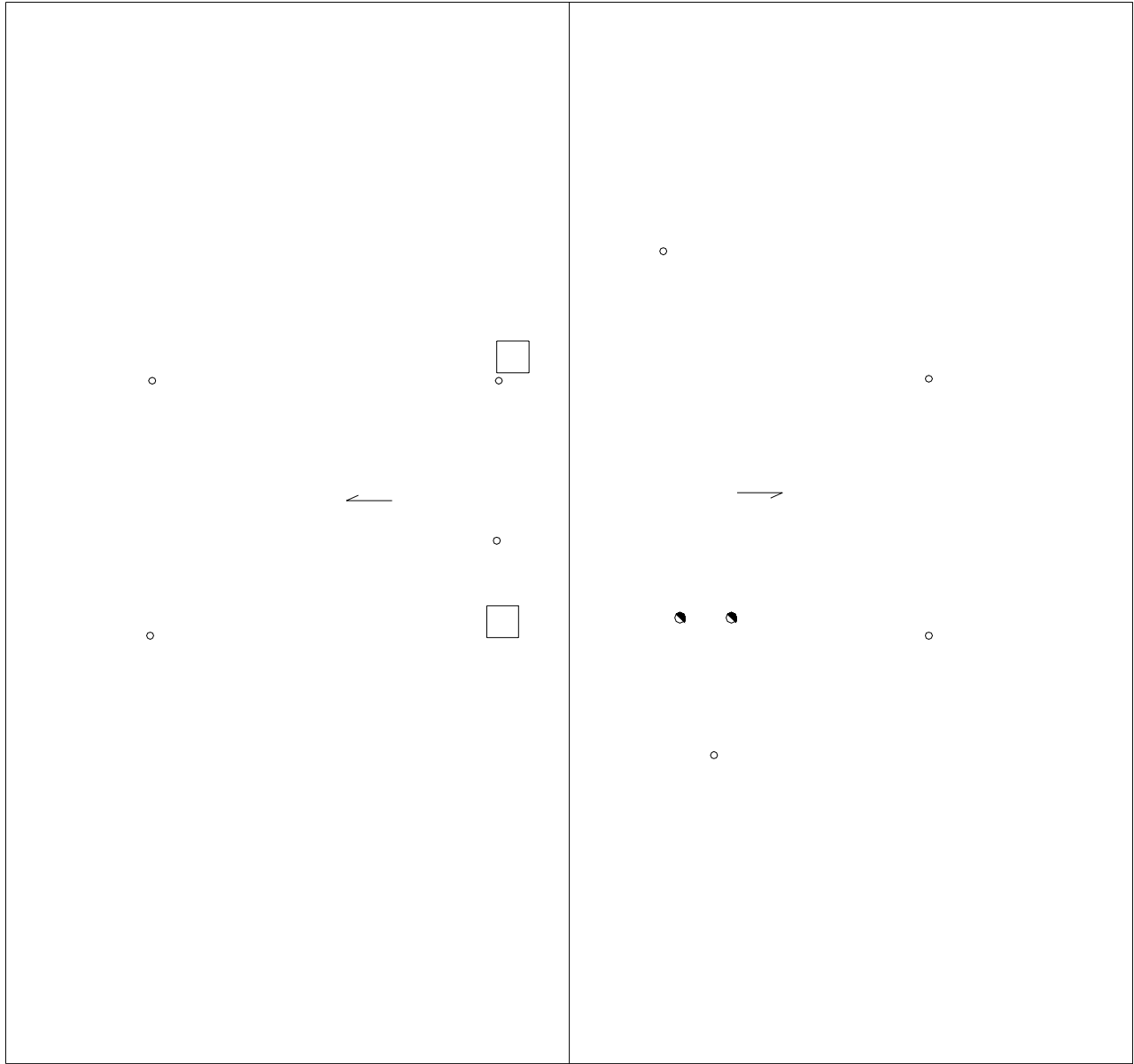

- SYMBOLS KEY
- ROOF CURB
  - VENT STACK
  - ↖ SLOPE DIRECTION
  - DEFECT-REPAIR
  - HEAT STACK

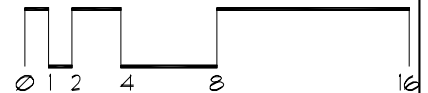

# Roof ID

Building: 48 - CT-48 - ()

Total Area: 2,650 sf

A 2,650 sf

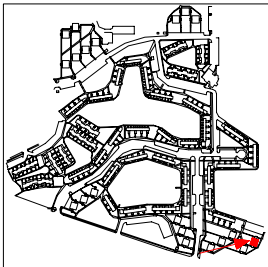
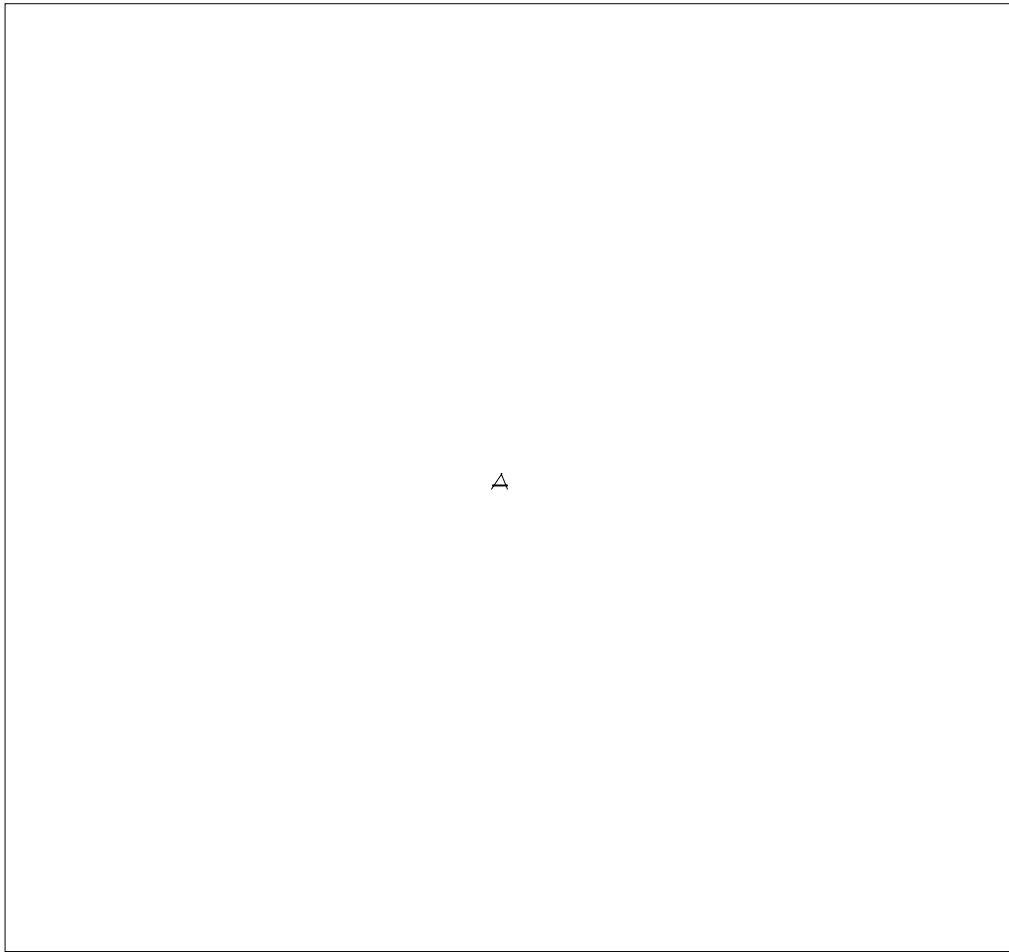

# Roof Corrective Action

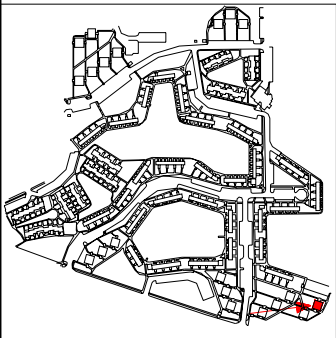
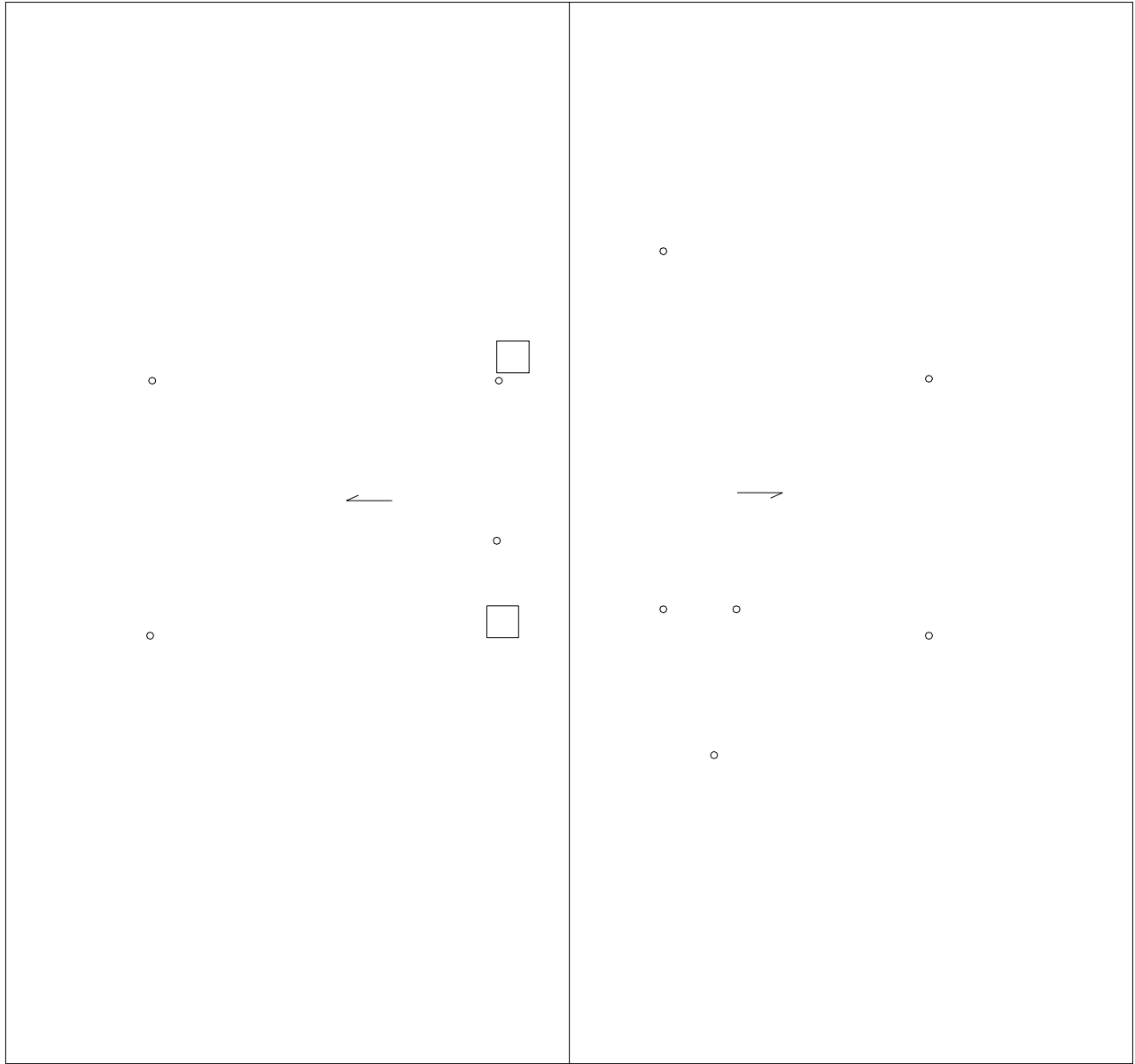

## SYMBOLS KEY

- ROOF CURB
- VENT STACK
- SLOPE DIRECTION

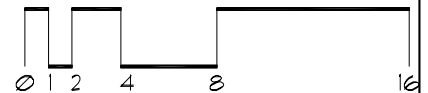

# Roof ID

Building: 49 - CT-49 - ()

Total Area: 2,650 sf

A 2,650 sf

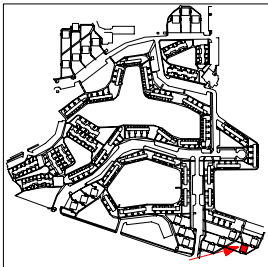
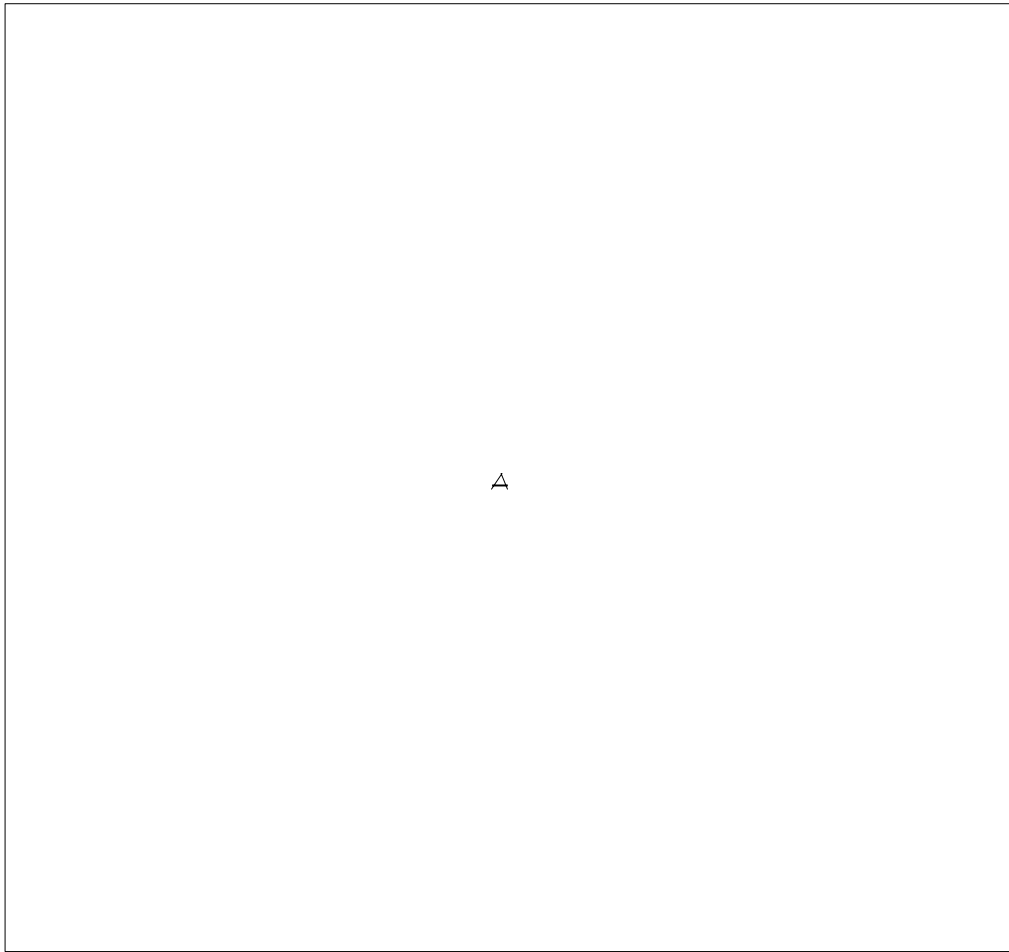

# Roof Corrective Action

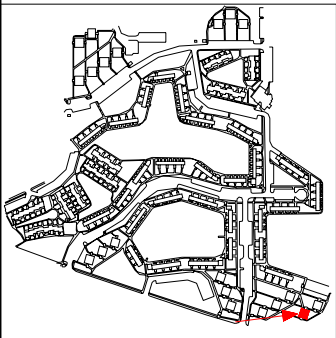
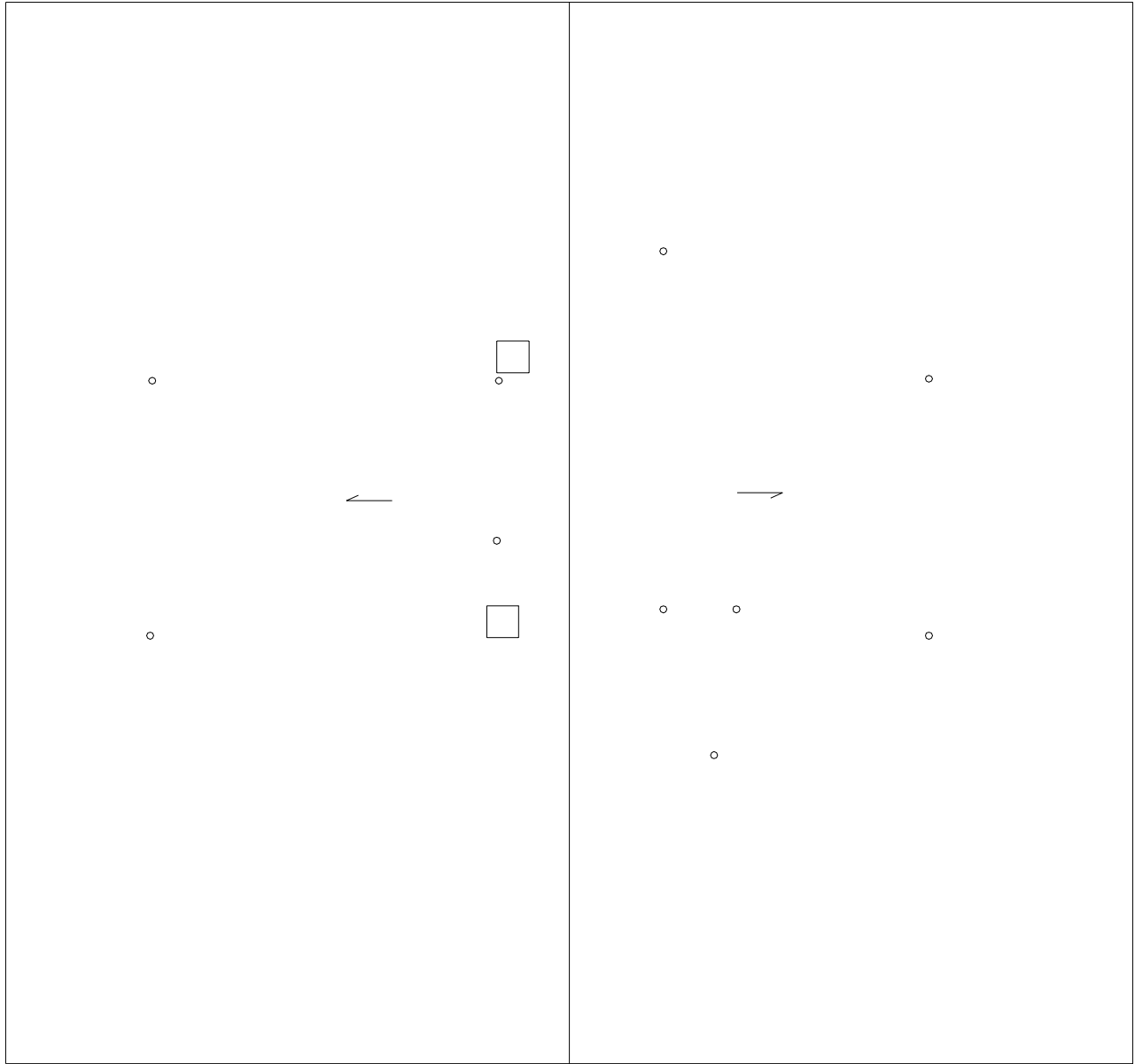

- SYMBOLS KEY
- ROOF CURB
  - VENT STACK
  - SLOPE DIRECTION

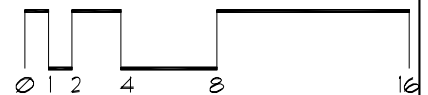

# Roof ID

Building: 50 - CT-50 - ()

Total Area: 5,500 sf

A 5,500 sf

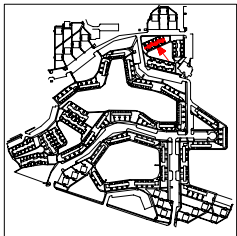
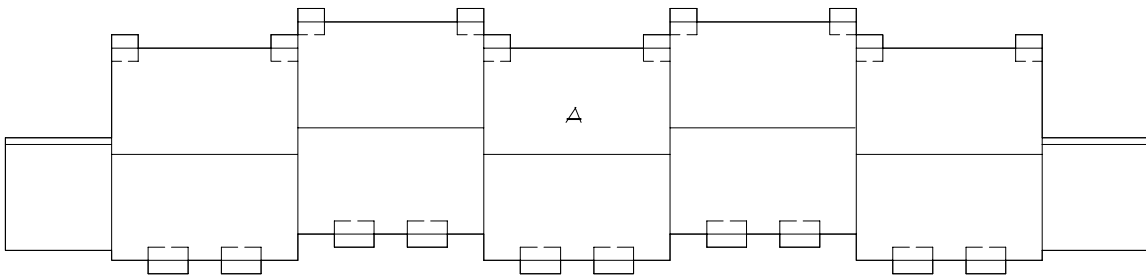



# Roof Corrective Action

## SYMBOLS KEY

- ROOF CURB
- VENT STACK
- Ⓢ DEFECT-REPAIR

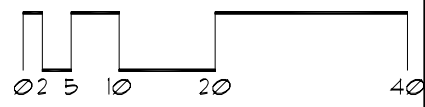
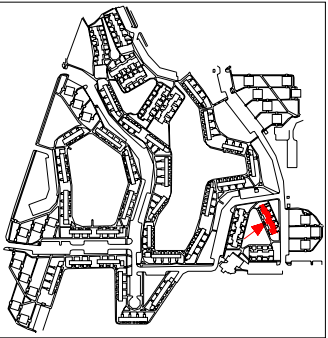
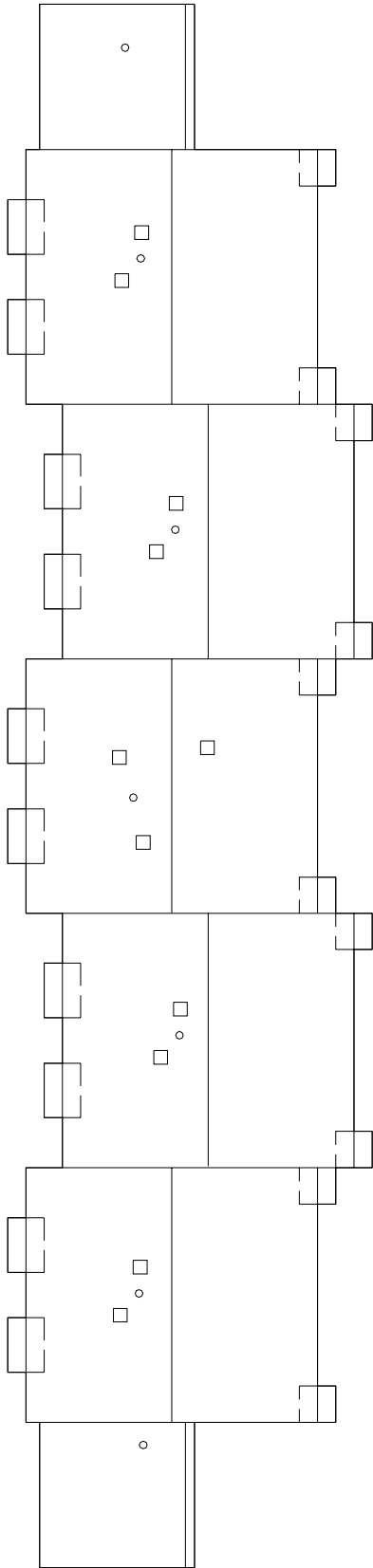

# Roof ID

Building: 51 - CT-51 - ()

Total Area: 4,500 sf

A 4,500 sf

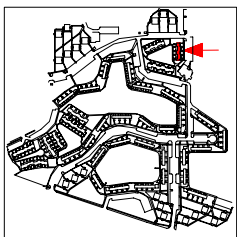
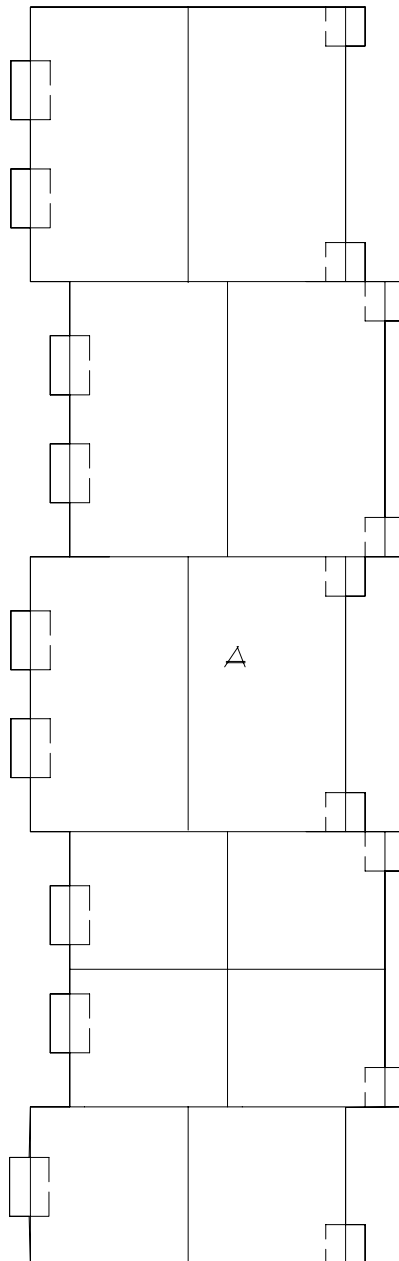

# Roof Corrective Action

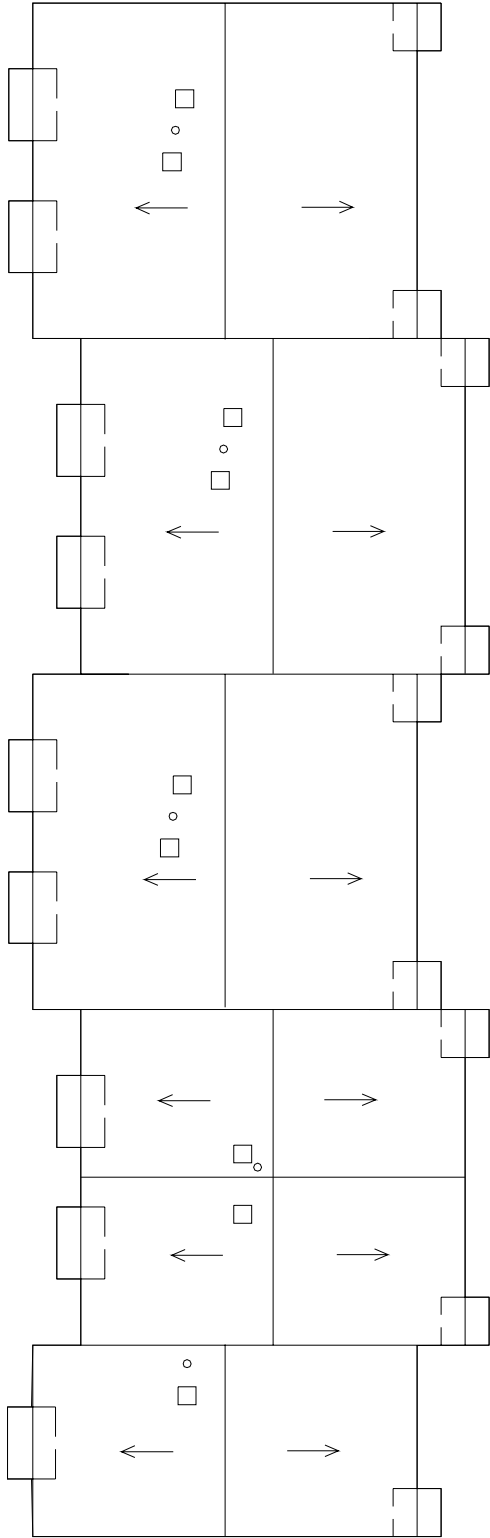

## SYMBOLS KEY

- ROOF CURB
- VENT STACK
- Ⓢ DEFECT-REPAIR
- STRUCTURAL SLOPE
- Ⓢ DEFECT-NO REPAIR

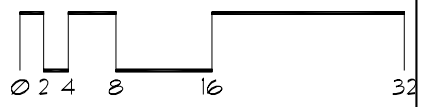
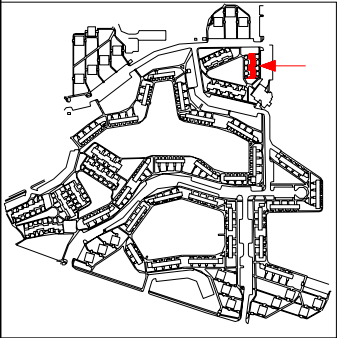

# Roof ID

Building: 52 - CT-52 - ()

Total Area: 7,619 sf

<u>A</u>	<u>1,313</u> sf	<u>E</u>	<u>3,076</u> sf
<u>B</u>	<u>2,140</u> sf	<u>F</u>	<u>646</u> sf
<u>C</u>	<u>340</u> sf	<u>G</u>	<u>68</u> sf
<u>D</u>	<u>36</u> sf		

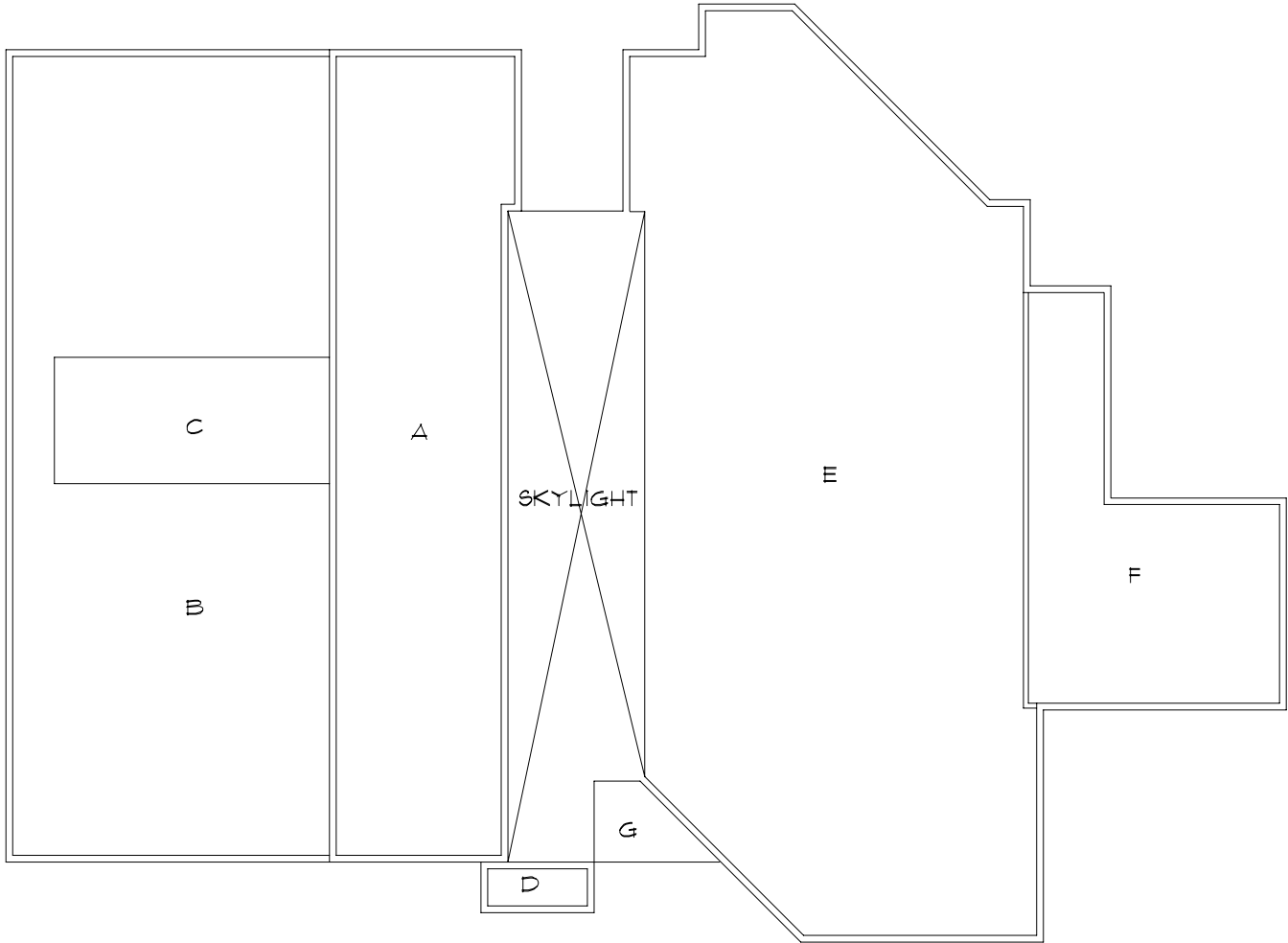

# Roof Corrective Action

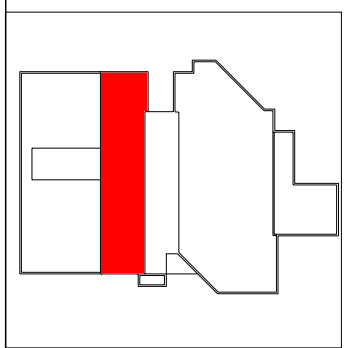
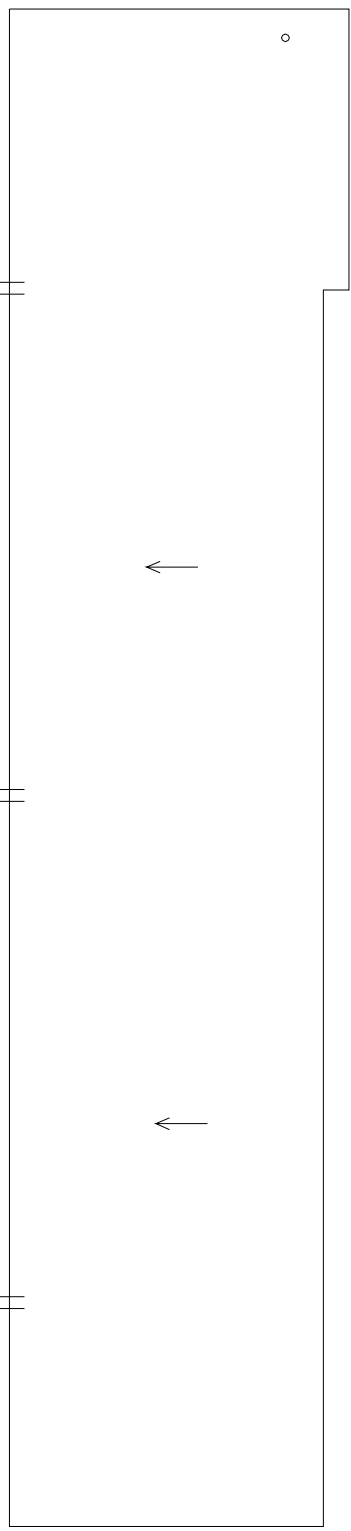

- SYMBOLS KEY**
- VENT STACK
  - ≡ SCUPPER
  - Ⓢ DEFECT-REPAIR
  - STRUCTURAL SLOPE

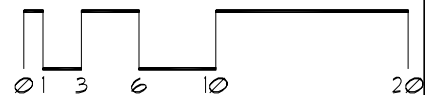

# Roof Corrective Action

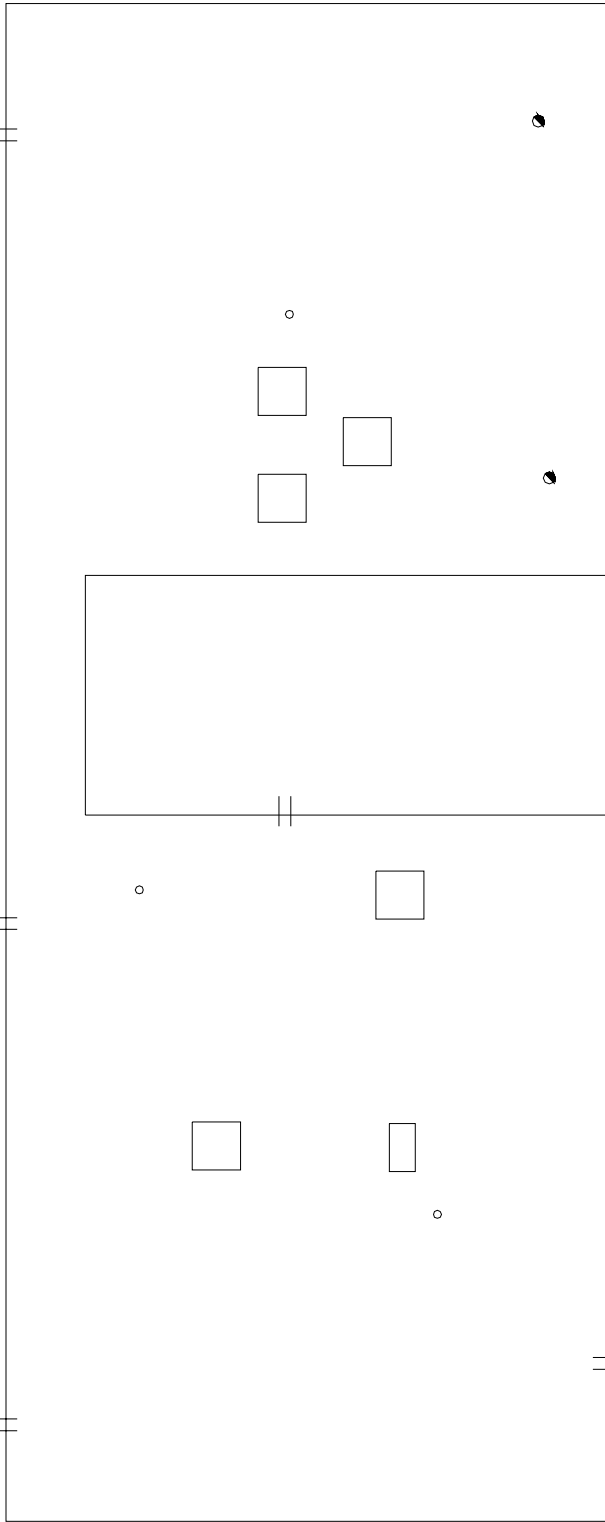

## SYMBOLS KEY

- ROOF CURB
- VENT STACK
- || SCUPPER
- DOWNSPOUT
- Ⓢ DEFECT-REPAIR
- Ⓣ DEFECT-NO REPAIR

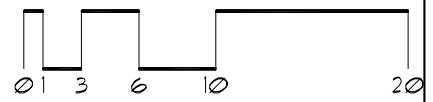
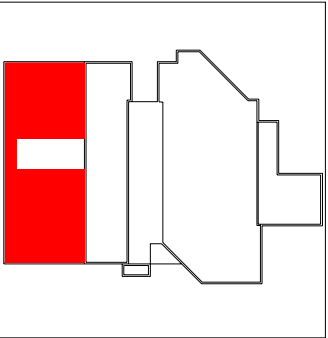

# Roof Corrective Action

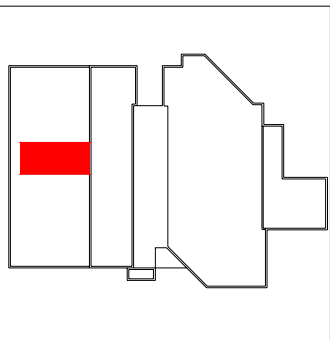
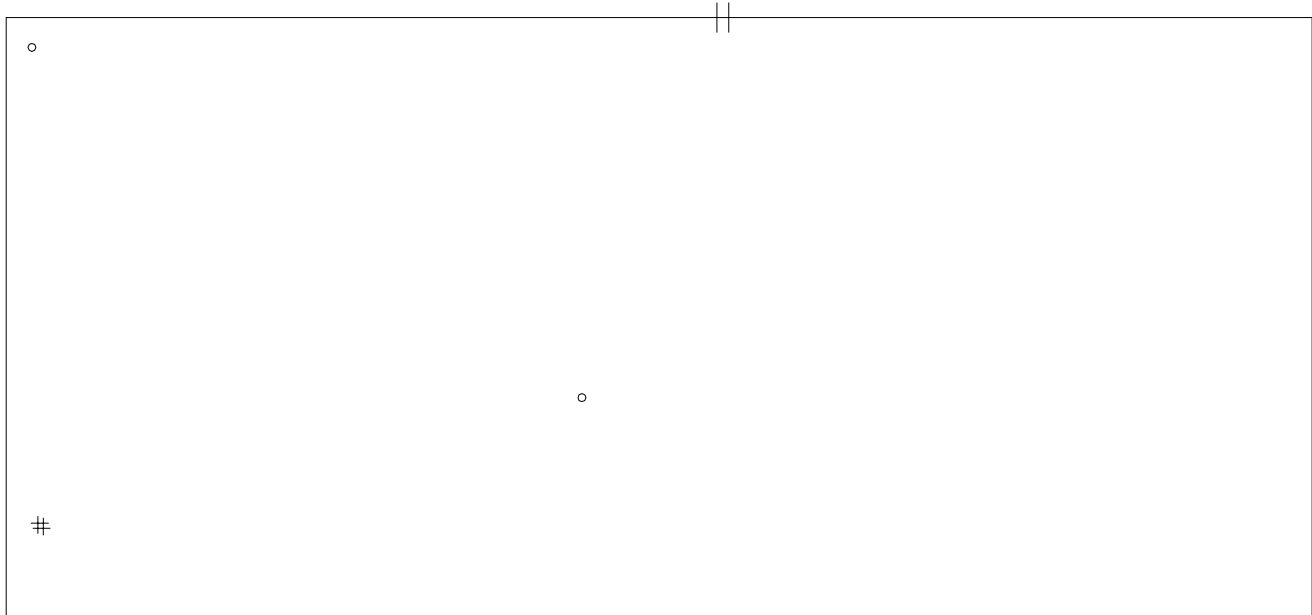

SYMBOLS KEY  
o VENT STACK  
|| SCUPPER  
# PITCH PAN

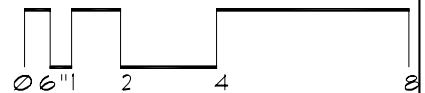

# Roof Corrective Action

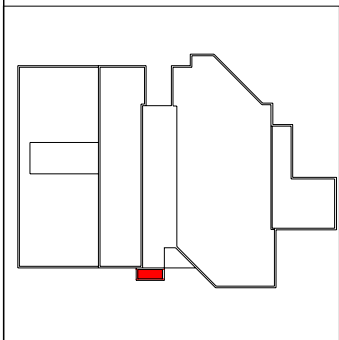
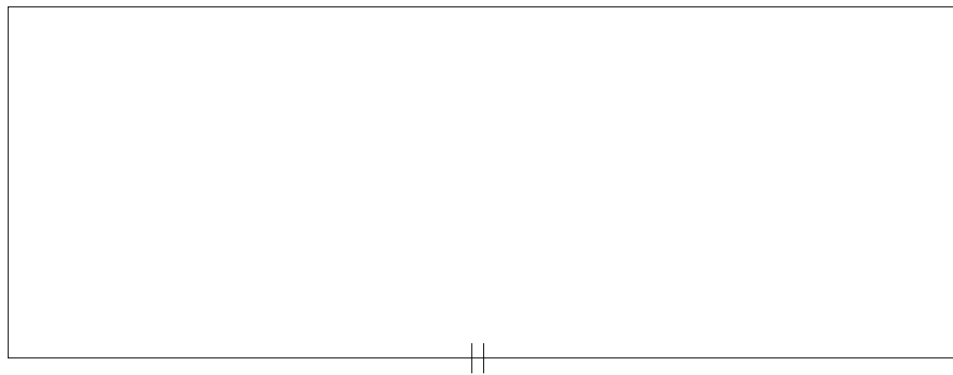

SYMBOLS KEY  
|| SCUPPER

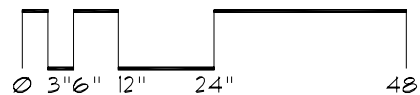



# Roof Corrective Action

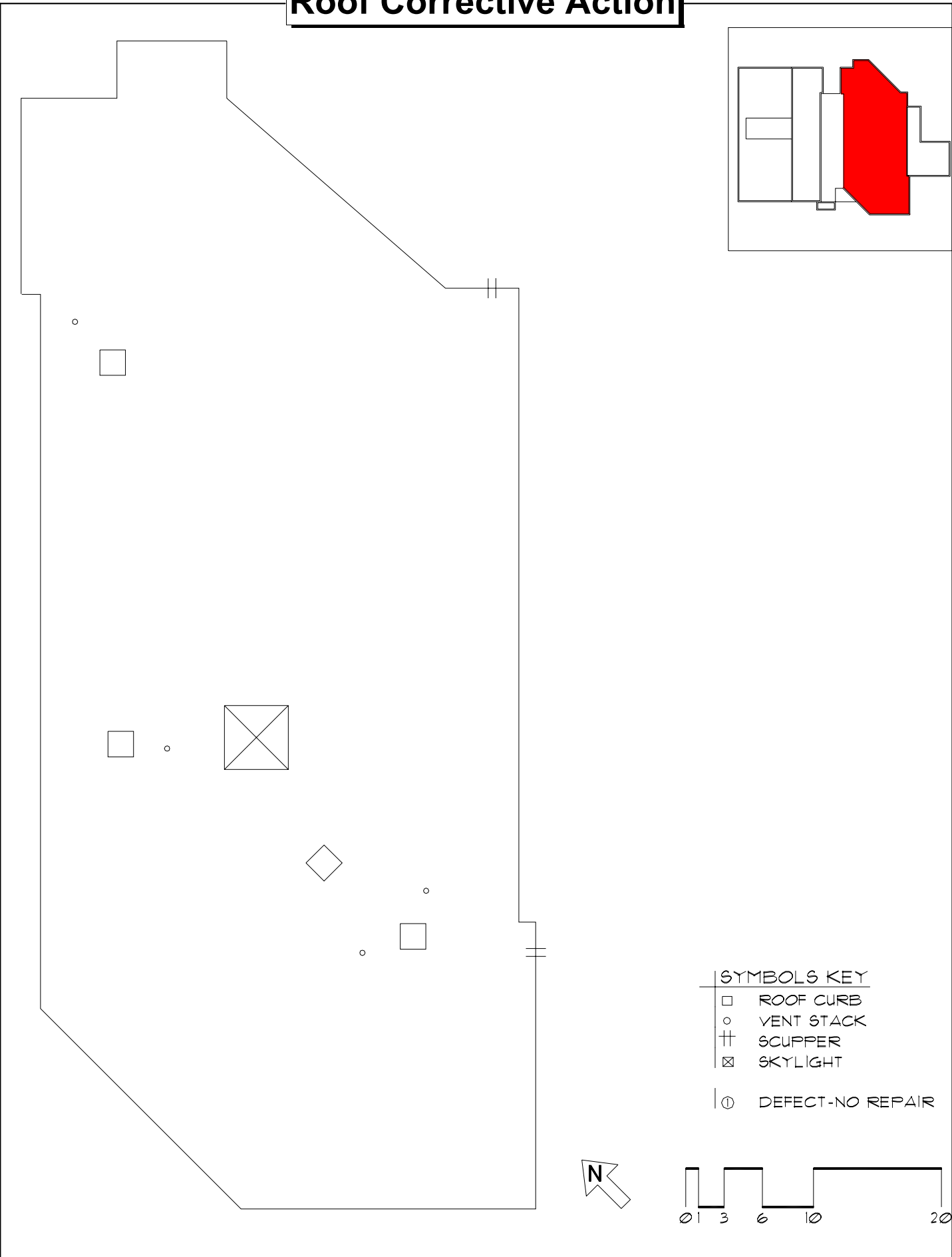
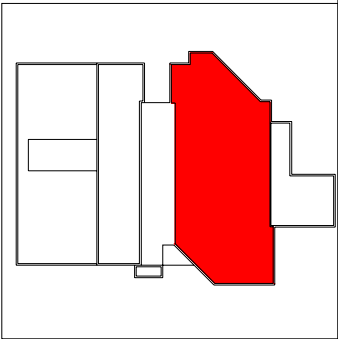

SYMBOLS KEY	
□	ROOF CURB
○	VENT STACK
⊥	SCUPPER
⊠	SKYLIGHT
①	DEFECT-NO REPAIR

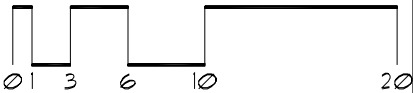

# Roof Corrective Action

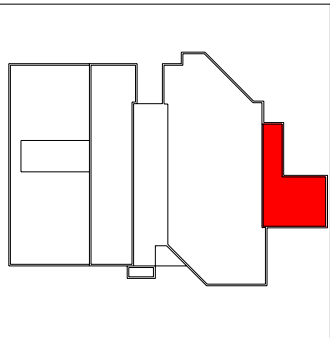
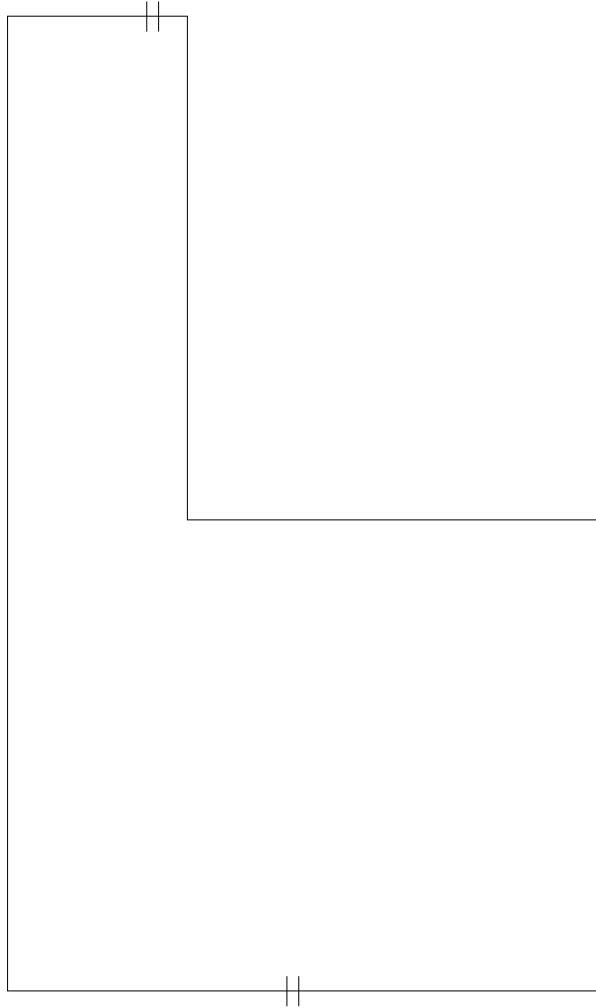

## SYMBOLS KEY

- ⦚ SCUPPER
- ⓪ DEFECT-REPAIR
- ⓪ DEFECT-NO REPAIR

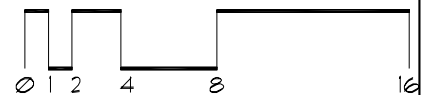

# Roof Corrective Action

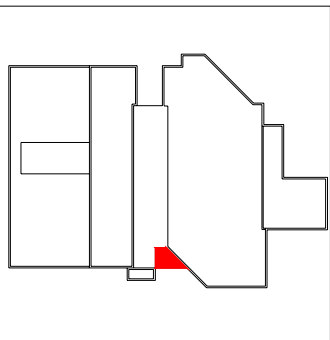
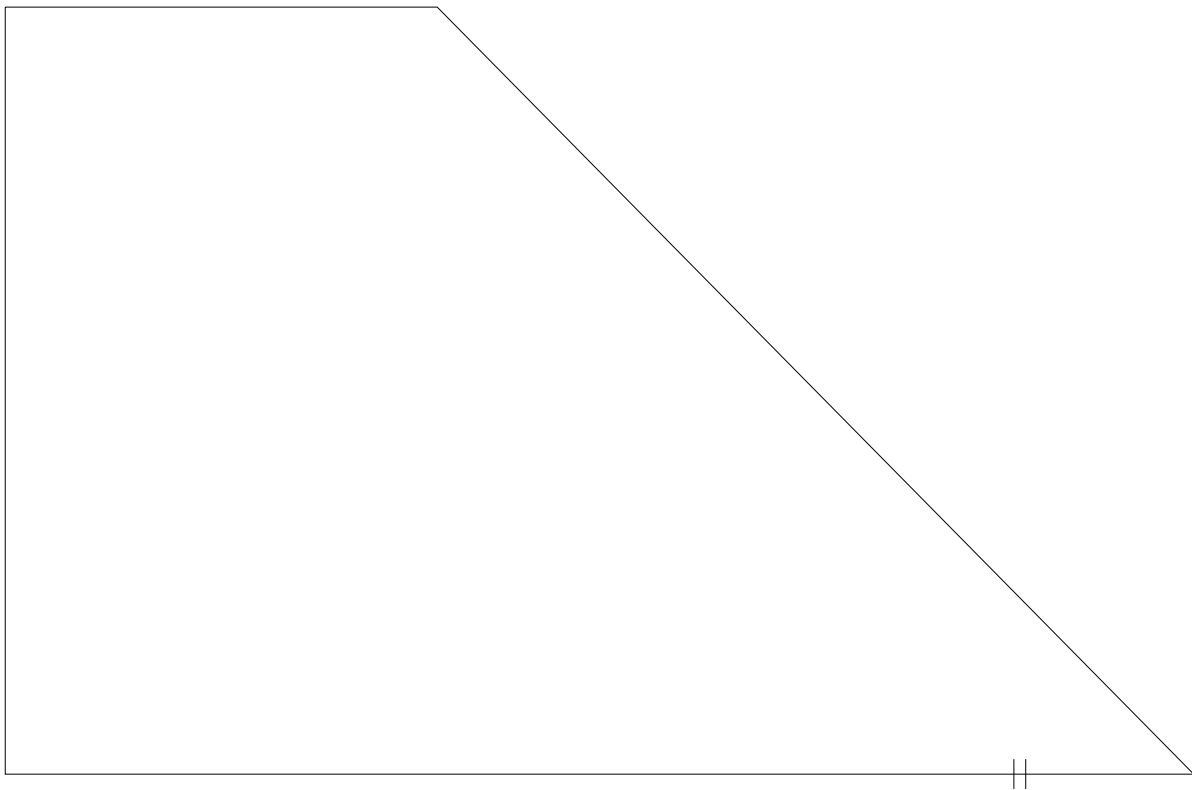

SYMBOLS KEY  
|| SCUPPER

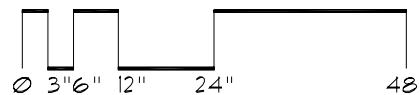

# Roof ID

Building: 53 - CT-53 - ()

Total Area: 8,045 sf

A 8,045 sf

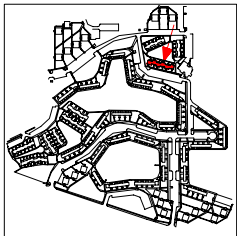
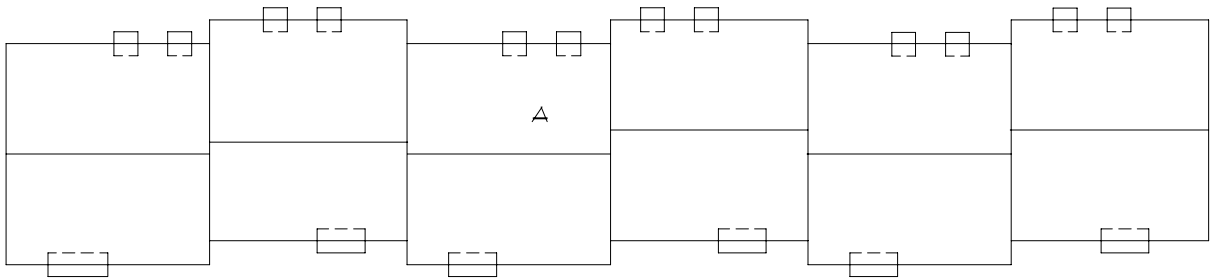

# Roof Corrective Action

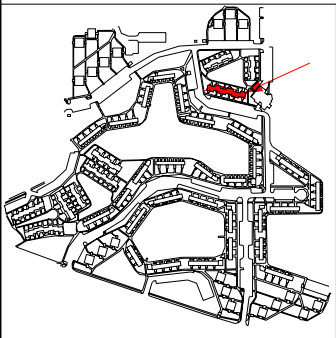
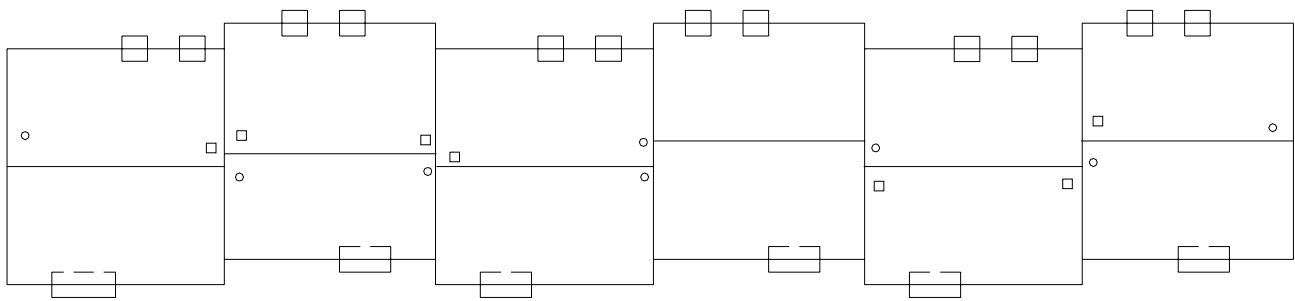

## SYMBOLS KEY

- ROOF CURB
- VENT STACK
- ① DEFECT-REPAIR

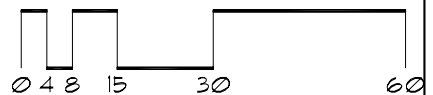

# Roof ID

Building: 54 - CT-54 - ()

Total Area: 6,875 sf

A 6,875 sf

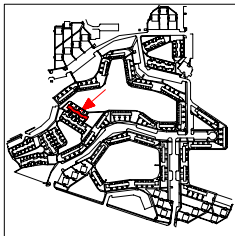
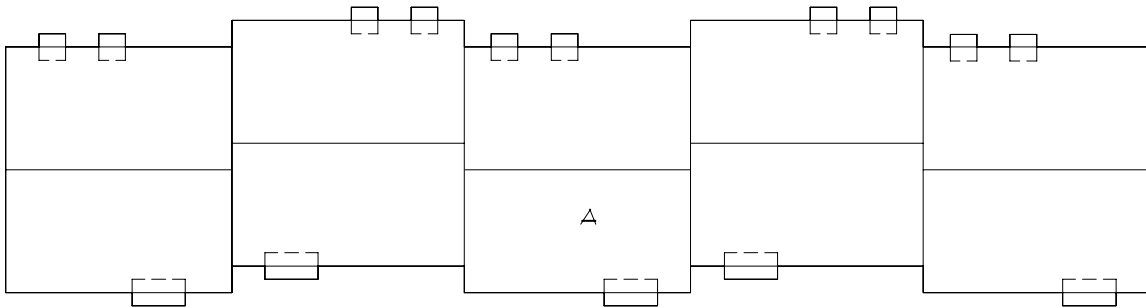

# Roof Corrective Action

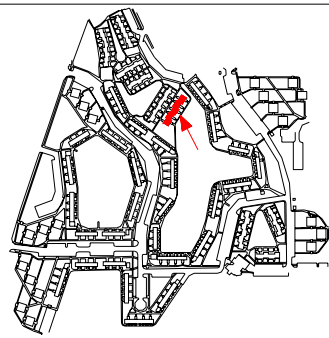
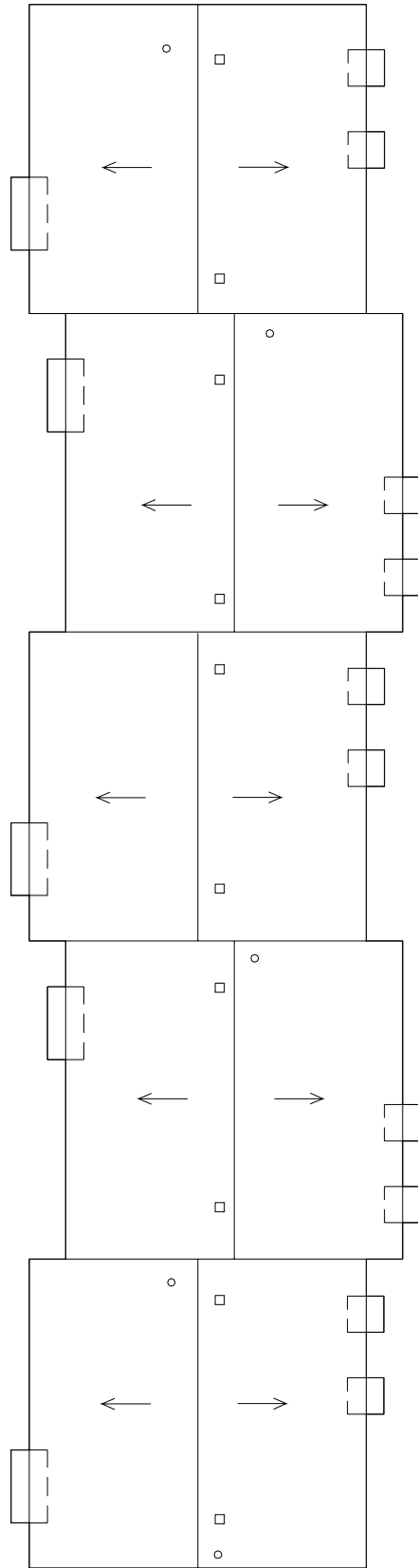

SYMBOLS KEY	
□	ROOF CURB
○	VENT STACK
⊖	DEFECT-REPAIR
→	STRUCTURAL SLOPE
⊕	DEFECT-NO REPAIR

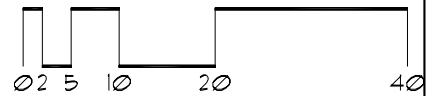

# Roof ID

Building: 55 - CT-55 - ()

Total Area: 7,100 sf

A 7,100 sf

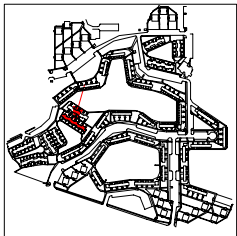
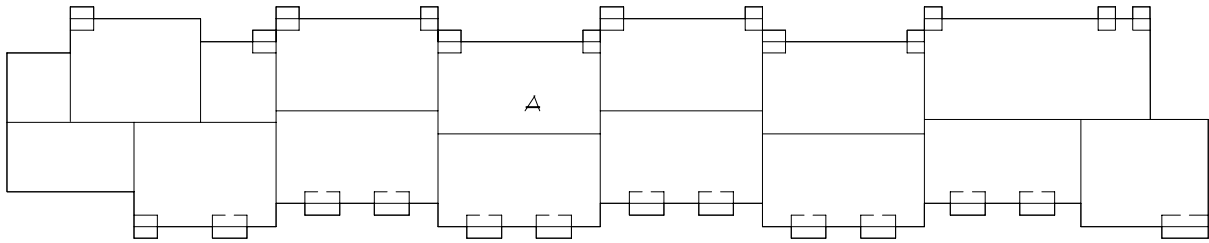



# Roof Corrective Action

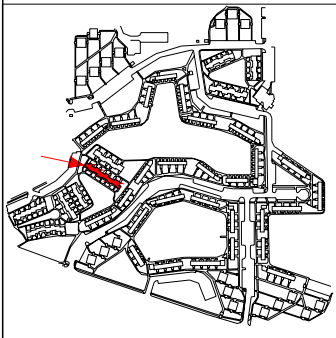
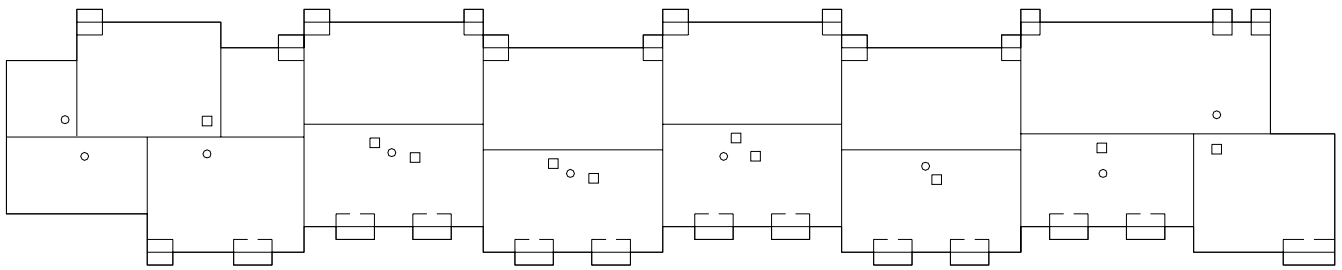

- SYMBOLS KEY**
- ROOF CURB
  - VENT STACK
  - Ⓣ DEFECT-REPAIR

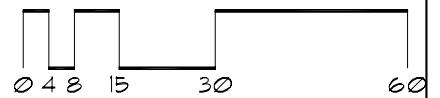

# Roof Corrective Action

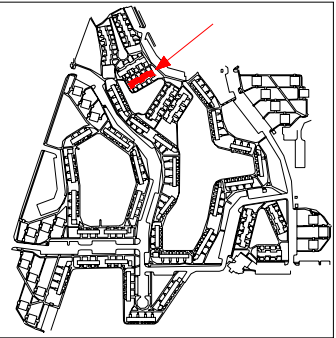
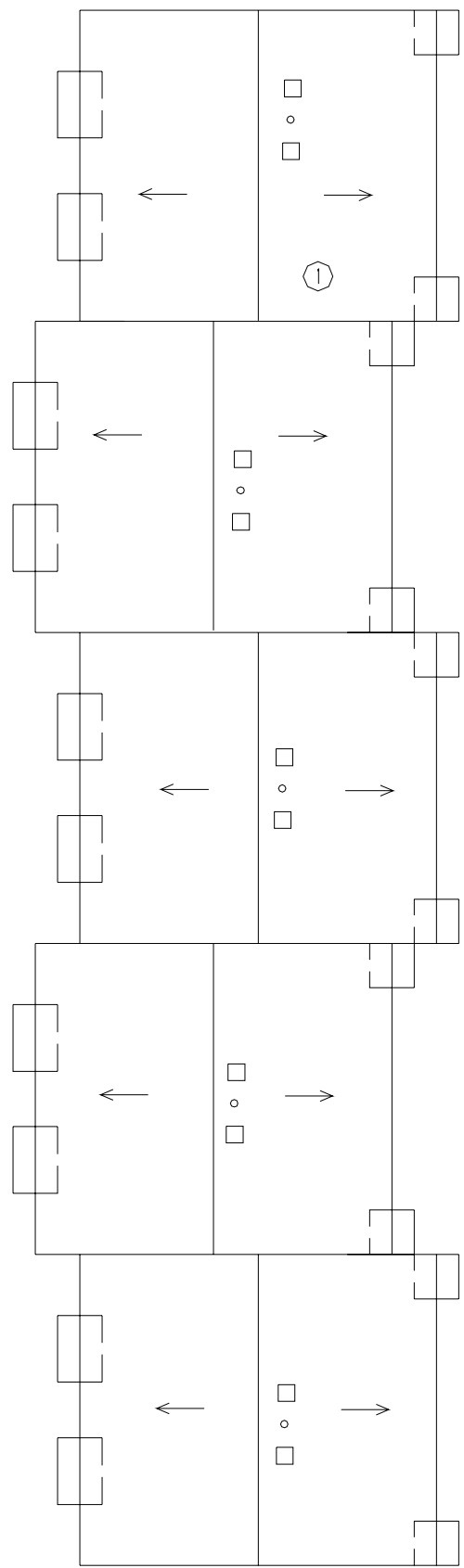

SYMBOLS KEY	
□	ROOF CURB
○	VENT STACK
⊘	DEFECT-REPAIR
→	STRUCTURAL SLOPE
⊘	DEFECT-NO REPAIR

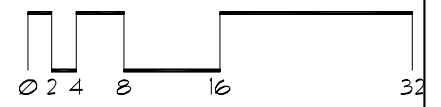
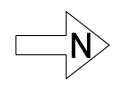

# Roof ID

Building: 57 - CT-57 - ()

Total Area: 5,438 sf

A 5,438 sf

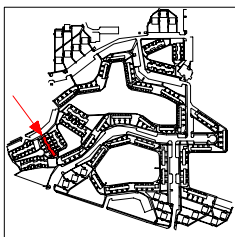
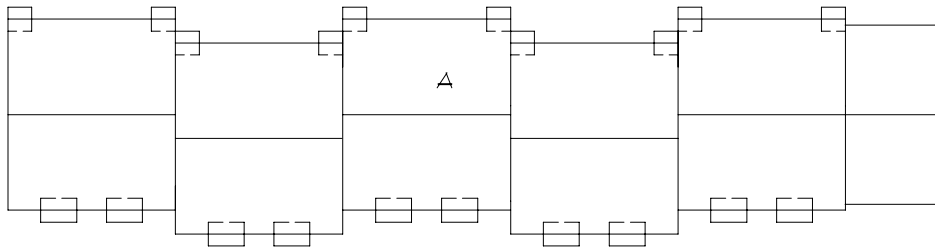

# Roof Corrective Action

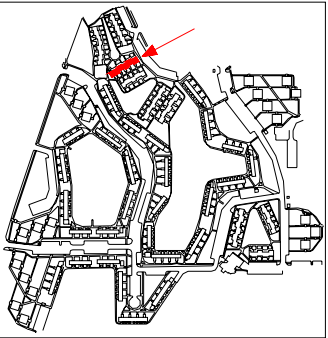
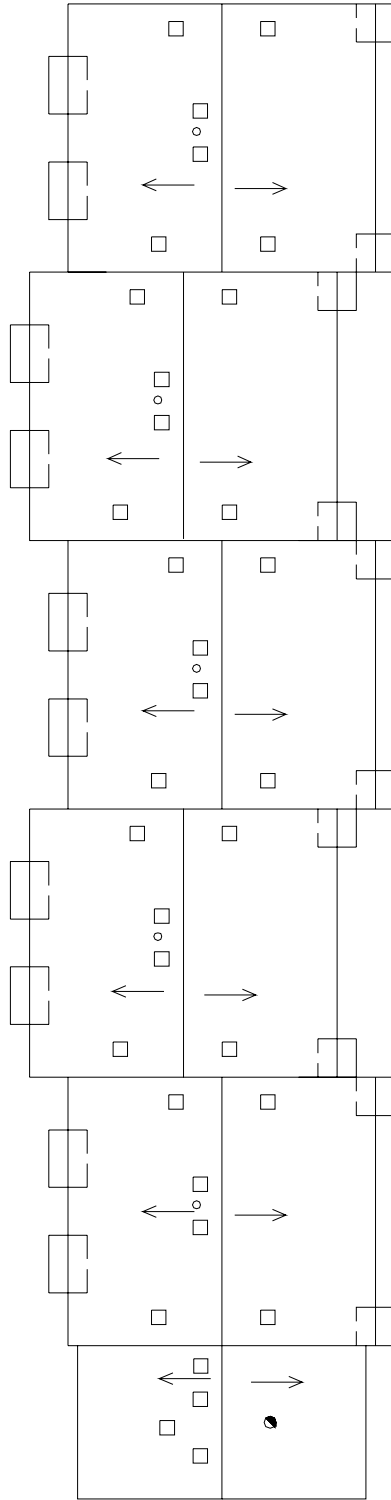

## SYMBOLS KEY

- ROOF CURB
- VENT STACK
- ⊖ DEFECT-REPAIR
- STRUCTURAL SLOPE
- HEAT STACK
- ⊕ DEFECT-NO REPAIR

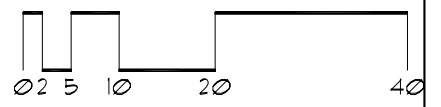
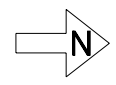

# Roof ID

Building: 58 - CT-58 - ()

Total Area: 6,105 sf

A 6,105 sf

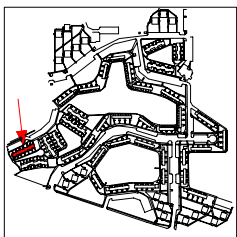
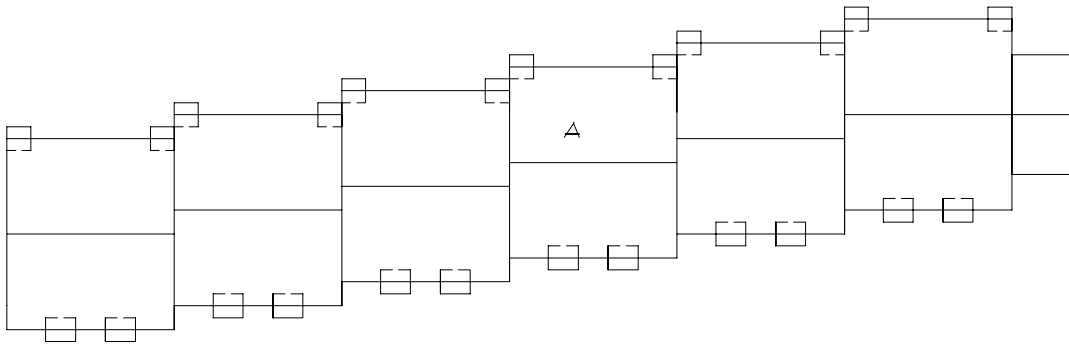

# Roof Corrective Action

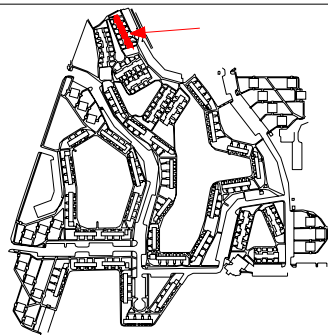
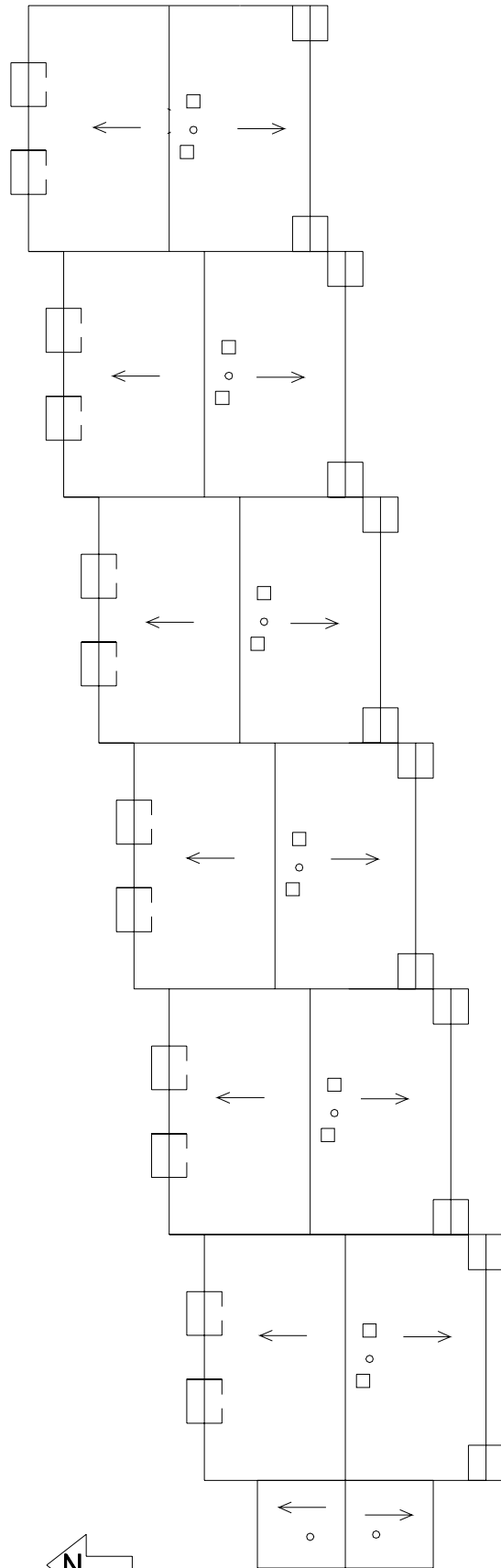

SYMBOLS KEY	
□	ROOF CURB
○	VENT STACK
⊖	DEFECT-REPAIR
→	STRUCTURAL SLOPE
⊕	DEFECT-NO REPAIR

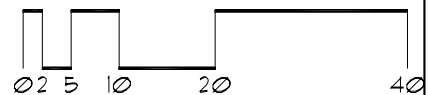

# Roof ID

Building: 59 - CT-59 - ()

Total Area: 7,858 sf

A 7,858 sf

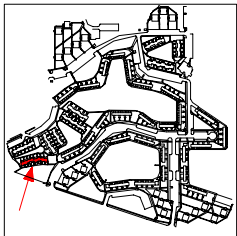
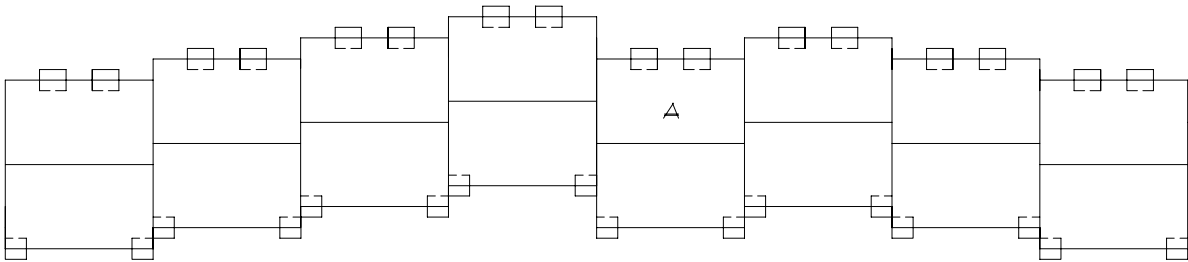

# Roof Corrective Action

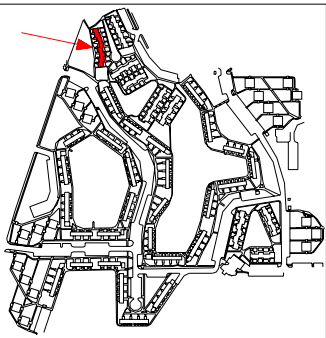
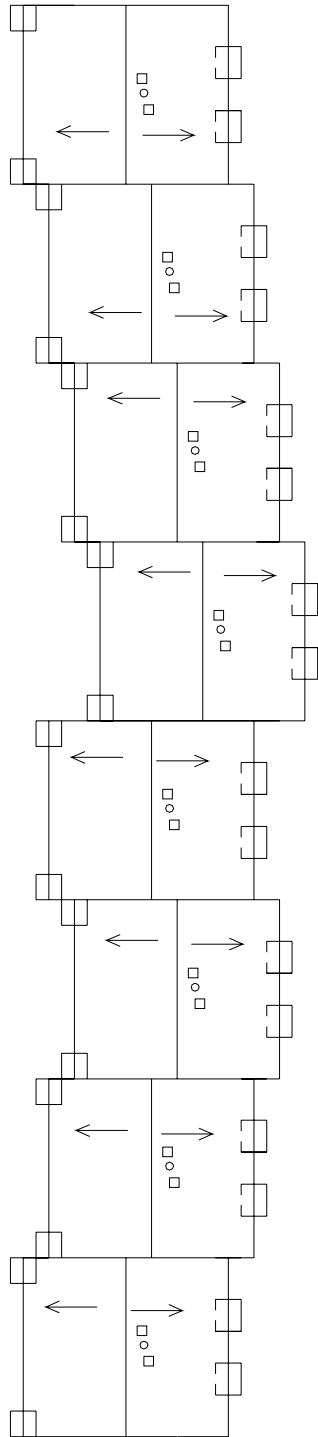

## SYMBOLS KEY

- ROOF CURB
- VENT STACK
- ⊖ DEFECT-REPAIR
- STRUCTURAL SLOPE
- ⊕ DEFECT-NO REPAIR

